

FS Series Remote IO

User Manual

DECOWELL Industrial Intelligence makes reliable partners



Website: www.decowellauto.com

Email: contact@decowellauto.com

Address: Building 13, Ruichuang Intelligent Manufacturing Park,
No. 19 Lanxin Road, Pukou District, Nanjing

Contents

- Preface5
- 1.System Overview7
 - 1.1 What is Remote IO7
 - 1.2 Composition7
 - 1.3 Features of the module7
 - 1.4 Application areas7
- 2.Module parameters8
 - 2.1 Naming conventions8
 - 2.2 Module communication protocol interface parameters8
 - 2.2.1 PROFINET protocol8
 - 2.2.2 EtherCAT protocol9
 - 2.2.3 CC-Link protocol10
 - 2.2.4 DeviceNet protocol10
 - 2.2.5 CC-LinkIE FieldBASIC Protocol11
 - 2.2.6 CANopen protocol12
 - 2.2.7 EtherNet/IP protocol13
 - 2.3 Module input/output channel technical parameters14
 - 2.3.1 XX-8800-C0NN14
 - 2.3.2 XX-8800-C1NN15
 - 2.3.3 XX-8800-C2NN16
 - 2.3.4 XX-HH00-C0NN17
 - 2.3.5 XX-HH00-C1NN19
 - 2.3.6 XX-S000-CNNN20
 - 2.3.7 XX-0S00-N0NN21
 - 2.3.8 XX-0S00-N1NN22
- 3.Module Installation24
 - 3.1 Basics24
 - 3.2 Installation clearance24
 - 3.3 IO Module installation and removal24

- 3.3.1 IO Module Installation 24
- 3.3.2 IO Module removal 25
- 4. Dimensions and Wiring Diagram 26
 - 4.1 Module Dimensions 26
 - 4.2 Module power wiring diagram 26
 - 4.3 Digital input channel wiring diagram 27
 - 4.3.1 Digital input channel NPN Signal wiring diagram 27
 - 4.3.1 Digital input channel PNP Signal wiring diagram 28
 - 4.4 Digital output wiring diagram 28
 - 4.4.1 Digital output NPN Wiring Diagram 28
 - 4.4.2 Digital output PNP Wiring Diagram 29
 - 4.5 Relay output wiring diagram 29
 - 4.5.1 Relay output DC load wiring diagram 29
 - 4.5.2 Relay output AC load wiring diagram 30
- 5. FS Series IO configuration 31
 - 5.1 EtherCAT Protocol 31
 - 5.1.1 TwinCAT3 and EtherCAT Protocol IO Module connections and configuration 31
 - 5.1.2 CODESYS and EtherCAT Protocol IO Module connections and configuration 33
 - 5.1.3 Sysmac Studio and EtherCAT Protocol I/O Module 36
 - 5.2 PROFINET Protocol 39
 - 5.2.1 TIA Portal and PROFINET Protocol IO Module connections and configuration 39
 - 5.2.2 Step7 Smart and PROFINET protocol IO module Connection and configuration 42
 - 5.2.3 CODESYS and PROFINET protocol IO module Connection and configuration 45
 - 5.3 CC-Link IE Field Basic protocol 50
 - 5.3.1 GX-Works2 and CC-Link IE Field Basic protocol IO module connections and configuration 50
 - 5.4 CC-Link protocol 56
 - 5.4.1 GX-Works2 and CCLink protocol IO Module connections and configuration 56
 - 5.5 DeviceNet Protocol 58
 - 5.5.1 CX-one and DeviceNet protocol IO Module connections and configuration 58
 - 5.6 CAN open protocol 63
 - 5.6.1 AutoShop with CANopen Protocol IO Modules 63
 - 5.6.2 InoProShop with CANopen Protocol IO Modules 66

5.7 EtherNet/IP Protocol 71

 5.7.1 KV STUDIO With EtherNet/IP protocol IOModule connections and configuration 71

 5.7.2 Machine Expert and EtherNet/IP protocol IO Module connections and configuration74

 5.7.3 CODESYS and EtherNet/IP Protocol IOModule connections and configuration 78

 5.7.4 Sysmac Studio and EtherNet/IP Protocol IO Module connections and configuration 82

Appendix 89

Preface

Copyright Notice

Copyright ©2020

Nanjing DECOWELL Automation Co., Ltd. Copyright, all rights reserved. Without the written permission of our company, no unit or individual may excerpt or copy part or all of the contents of this document without authorization, and may not disseminate it in any form.

DECOWELL WELLINKIO are trademarks of our company. Other registered trademarks appearing in this document are owned by their respective owners.

Due to product version upgrades or other reasons, the contents of this document are subject to periodic updates. Unless otherwise agreed, this document is for reference only, and all statements, information, and recommendations contained herein do not constitute any express or implied warranty.

Scope of this document

This document is applicable to FS Series Remote IO system

Introduction

This manual mainly introduces FS technical specifications, installation, and commissioning of the series of remote I/O modules. The main contents include:

- **System Overview:** Provides an introduction to the FS Series remote I/O modules, including ordering information, product composition, system architecture, as well as transportation and storage environment.
- **Product Description:** Details the technical specifications of the FS Series remote I/O modules.
- **Installation and Removal Guide:** Describes how to install and remove the FS Series remote I/O modules.
- **Mechanical and Electrical Drawings:** Includes dimensional drawings and electrical wiring diagrams of the FS Series remote I/O modules.
- **User Guide:** Demonstrates how the FS Series remote I/O modules communicate and connect with various mainstream PLCs through practical examples.

Precautions

This document describes in detail the WELL-LINK FS usage of the series remote I/O modules is for people with certain engineering experience. Nanjing DECOWELL is not responsible for any consequences caused by the use of this information.

Before attempting to use the device, please read the relevant precautions of the device carefully and be sure to comply with the installation and commissioning safety precautions and operating procedures. For the possible hazards and damages caused by incorrect use of the device, please refer to the following symbols.

	Warn
This mark indicates "Dangers caused by failure to follow the instructions may result in personal	
	Notice
This mark indicates "Dangers caused by failure to follow the instructions may result in minor or	
	Tips
This mark indicates "Make necessary supplements or explanations to the description of the	

Target customers

This manual provides information about FS Installation and commissioning information for a range of remote I/O modules, designed for engineers, installers, maintenance personnel and electricians with general automation knowledge.

Recycling and Disposal

To ensure environmentally friendly recycling and disposal of your old device, please contact a certified electronic waste disposal service.

Online Support

In addition to this manual, you can also obtain more product information by checking the official website.

<http://www.decowellauto.com>

1. System Overview

1.1 What is Remote IO

Remote I/O, also known as distributed I/O, refers to electronic devices commonly used in process or factory automation that transmit and receive input and output signals to and from main electronic equipment (such as DCS, PLC, or PC) via communication technologies like industrial fieldbus.

1.2 Composition

The FS Series remote I/O modules mainly consist of system status indicators, system power supply, input/output channels, communication interface, and I/O channel indicators, as shown in Figure 1-2.

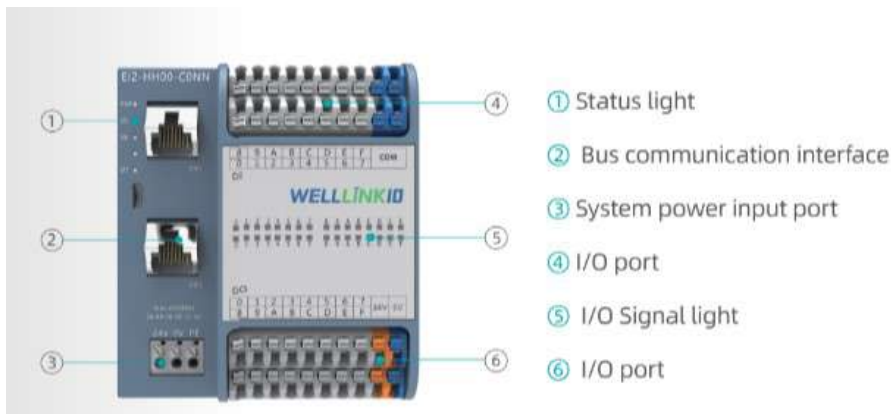

Figure 1-2 FS Series Remote IO Module composition

1.3 Features of the module

The FS Series remote I/O modules feature an integrated design that combines the communication interface, input/output I/O interfaces, system and I/O indicators. They are characterized by high integration, rich communication protocols, compact size, and ease of use.

1.4 Application areas

The FS Series remote I/O modules are widely used across various fields, such as new energy, lithium battery, non-standard automation, robotics, CNC machines, intelligent parking systems, logistics sorting, educational equipment, environmental protection, and heating systems.

2.Module parameters

2.1 Naming conventions

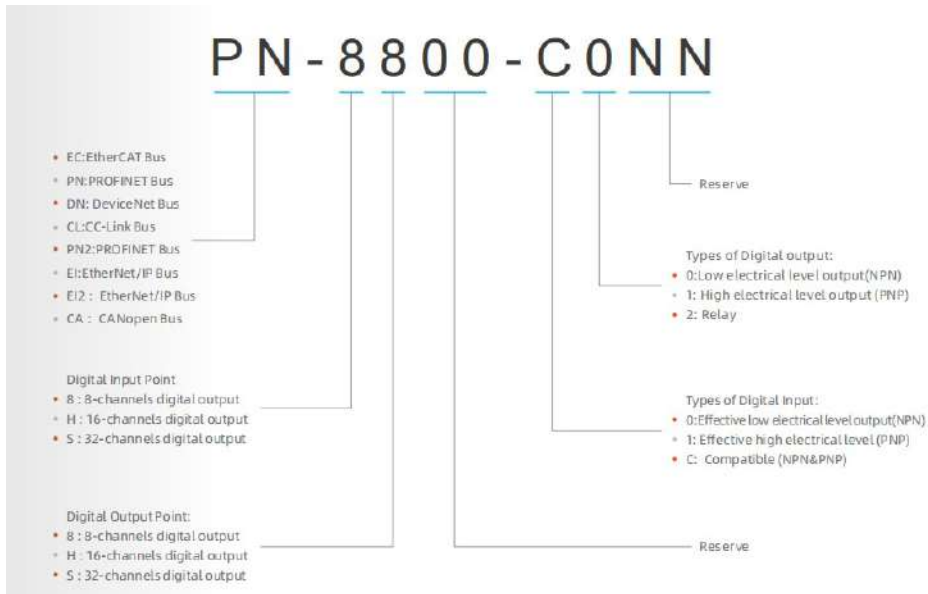

2.2 Module communication protocol interface parameters

It mainly introduces parameters such as bus protocol, interface type, interface mode and communication rate in the module.

2.2.1 PROFINET protocol

PROFINET Module Communication Protocol Interface Parameters	
Bus protocol	PROFINET
Interface Type	Industry EtherNET
Interface	2×RJ45
Communication rate	100Mbps
Communication distance	100m (distance between stations)
Electrical isolation	have

PN Module system indicator light description

NO.	Indicator Lights	Illustrate	Color	State	Meaning
1	POWER	Power indicator	green	ON	Power supply is normal
				OFF	The power supply is disconnected or faulty.
2	RUN	Running indicator light	green	ON	Equipment running and the communication is normal
				OFF	No power or system abnormality
3	SF	---	---	---	---
4	BF	System fault indicator	red	ON	Communication abnormality
				OFF	Equipment running and the communication is normal

PN2 Module system indicator light description

No.	Indicator Lights	illustrate	color	state	meaning
1	POWER	Power indicator	green	ON	Power supply is normal
				OFF	The power supply is disconnected or faulty.
2	RUN	Running indicator light	green	ON	The equipment is running and the communication is normal
				OFF	No power or system abnormality
3	SF	---	---	---	---
4	BF	System fault indicator	red	ON	Communication abnormality
				OFF	The equipment is running and the communication is normal
5	MT	Maintenance indicator	green	Flash 5HZ	Flashing during the upgrade process
				Flash 1HZ	Flashes when the reset button is pressed
				ON	Reset operation completed
				OFF	Non-maintenance status

2.2.2 EtherCAT protocol

EtherCATModule communication protocol interface parameters	
Bus protocol	EtherCAT
Interface Type	Industry EtherNET
Interface	2×RJ45
Communication rate	100Mbps
Communication distance	100m (distance between stations)
Electrical isolation	have

EtherCAT Module system indicator light description

NO.	Indicator Lights	illustrate	color	state	meaning
1	POWER	Power indicator	green	ON	Power supply is normal
				OFF	The power supply is disconnected or faulty.
2	RUN	Running indicator light	green	ON	OP Status, running normally
				OFF	INIT Status, initialization status
				Flash	PRE-OP Status, communication initialization completed
				Single flash	SAFE-OP Status, SDO and PDO Unavailable
3	ERR	System fault indicator	red	ON	Application controller failure
				OFF	No Error
				Flashes twice	Process data watchdog timeout/EtherCAT watchdog timeout
				Flash once	Local Error
				Flash	Configuration Error

2.2.3 CC-Link protocol

- CC-Link module communication protocol interface parameters

CC-Link module communication protocol interface parameters	
Bus protocol	CC-Link
Working Mode	CC-Link remote I/O station
Connection	Shielded twisted pair
Communication rate	156kbps~10Mbps
Address Configuration	1~64
Electrical isolation	have

- CC-Link remote IO Module DIP Setting

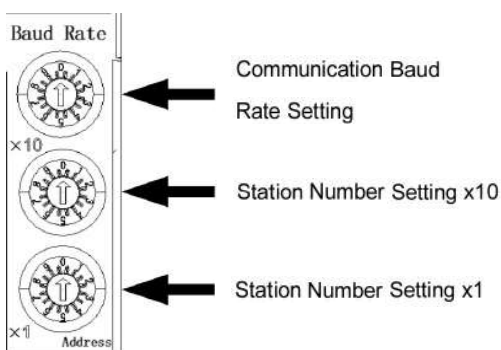

CCLink communication rate setting		
Dial position number	Communication rate	Corresponding transmission distance
0	156kbps	1200m
1	625kbps	600m
2	2.5Mbps	200m
3	5Mbps	150m
4	10Mbps	100m

CC Link module system indicator light description

NO.	Indicator Lights	illustrate	color	state	meaning
1	POWER	Power indicator	green	ON	Power supply is normal
				OFF	The power supply is disconnected or faulty.
2	RUN	Running indicator light	green	ON	The equipment is running and the communication is normal
				OFF	Connection not established
3	ERR	System fault indicator	red	ON	Module communication abnormality
				OFF	Module communication is normal

2.2.4 DeviceNet protocol

- DeviceNet module communication protocol interface parameters

DeviceNet Module communication protocol interface parameters	
Bus protocol	DeviceNet
Connection	Shielded twisted pair
Communication rate	125kbps/250kbps/500kbps
Address Configuration	0~63
Electrical isolation	have

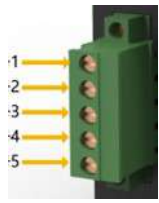
DeviceNet communication interface	Position No.	Signal	Signal Definition
	1	V+	Positive power supply
	2	CH	Data signal positive
	3	SLD	Shielded wire
	4	CL	Data signal negative
	5	V-	Negative pole of power supply

- DeviceNet Remote IO Module communication interface definition
- DeviceNet Remote IO Module DIP Setting

Baud Rate

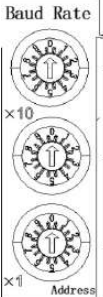

Communication Baud Rate Setting

Station Number Setting x10

Station Number Setting x1

DeviceNet communication rate setting	
0	125kbps
1	250kbps
2	500kbps

DeviceNet module system indicator light description

NO.	Indicator Lights	illustrate	color	state	meaning
1	POWER	Power indicator	green	ON	Power supply is normal
				OFF	The power supply is disconnected or faulty.
2	RUN	Running indicator light	green	ON	The equipment is running and the communication is normal
				OFF	Connection not established
3	ERR	System fault indicator	red	ON	Module communication abnormality
				OFF	Module communication is normal

2.2.5 CC-LinkIE FieldBASIC Protocol

CC-Link IE Field BasicModule communication protocol interface parameters	
Bus protocol	CC-Link IE Field Basic
Interface Type	Industry EtherNET
Interface	2×RJ45
Communication rate	100Mbps
Communication distance	100m (distance between stations)
Electrical isolation	have

CC-Link IE Field BASIC module system indicator light description

NO.	Indicator Lights	illustrate	color	state	meaning
1	POWER	Power indicator	green	ON	Power supply is normal
				OFF	The power supply is disconnected or faulty.
2	RUN	Running indicator light	green	ON	The equipment is running and the communication is normal
				OFF	Connection not established
				Flash	Factory reset signal detected
3	ERR	System fault indicator	red	ON	Module communication abnormality
				OFF	Module communication is normal

2.2.6 CANopen protocol

- CANopen module communication protocol interface parameters

CANopen module communication protocol interface parameters	
Bus protocol	CANopen
Connection	Shielded twisted pair
Communication rate	10kbps~1Mbps
Address Settings	DIP switch settings
Communication distance	The maximum communication distance is determined by the communication rate
Electrical isolation	have

CANopen communication interface	Position No.	Signal	Signal Definition
	1	+V	Positive power supply
	2	CH	Data signal positive
	3	SLD	Shielded wire
	4	CL	Data signal negative
	5	-V	Negative pole of power supply

- CANopen remote IO Module communication interface definition
- CANopen remote IO Module DIP Setting

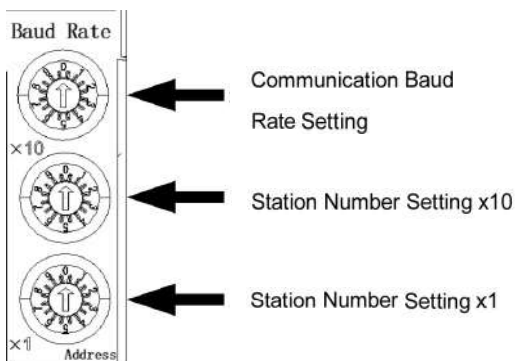

CANopen communication rate setting	
0	10kbps
1	20kbps
2	50kbps
3	100kbps
4	125kbps
5	250kbps
6	500kbps
7	1000kbps

CC-LinkIE FieldBASIC module system indicator light description

NO.	Indicator Lights	illustrate	color	state	meaning
1	POWER	Power indicator	green	ON	Power supply is normal
				OFF	The power supply is disconnected or faulty.
2	RUN	Running indicator light	green	ON	The module enters the operating state and the communication is normal.
				OFF	The module enters the initialization state
				1 flash long off	The module enters the operation stop state
				5HZ Flash	The module enters pre-operationstate;
3	ERR	System fault indicator	red	ON	Module failure
				OFF	The module enters the running state

2.2.7 EtherNet/IP protocol

EtherNet/IP Module communication protocol interface parameters	
Bus protocol	EtherNet/IP
Interface Type	Industry EtherNET
Interface	2×RJ45
Communication rate	100Mbps
Communication distance	100m (distance between stations)
Electrical isolation	have

EtherNet/IPModule system indicator light description

NO.	Indicator Lights	illustrate	color	state	meaning
1	POWER	Power indicator	green	ON	Power supply is normal
				OFF	The power supply is disconnected or faulty.
2	MS	Module status indicator	green	ON	The equipment is operating normally
				1HZFlash	Standby, device not configured yet
			Red and Green	1HZFlash	Self-test, the device is performing a power-on test
				OFF	The device has no power
			red	ON	Main faults: The device has detected a major, unrecoverable fault.
				1HZFlash	No power supply:The device is missing power.
3	NS	Network status indicator	green	ON	Connected, the device has at least one established connection
				1HZFlash	No connection, the device has not established a connection
			Red and Green	1HZFlash	Self-test, the device is performing a power-on test
				OFF	No power or no IP address

			red	ON	Repeat IP address
			red	1HZFlash	Connection timed out. One or more connections to this device have timed out.
4	MT	Maintenance indicator	green	Flash 5HZ	Flashing during the upgrade process
				Flash 1HZ	Flashes when the reset button is pressed
				ON	Reset operation completed
				OFF	Non-maintenance status

2.3 Module input/output channel technical parameters

2.3.1 XX-8800-C0NN

Tip: XX represents the bus protocol to be selected (for example:PN、EC, CL, CI, CA etc.), the input and output parameters and external dimensions of the modules are consistent.

- XX-8800-C0NN Integrated module model

model	Specifications
XX-8800-C0NN	8-channel digital input (NPN & PNP) 8-channel digital output (NPN)
XX-8800-C1NN	8-channel digital input (NPN & PNP) 8-channel digital output (PNP)
XX-8800-C2NN	8-channel digital input (NPN & PNP) 8-channel digital output (relay)
XX-HH00-C0NN	16-channel digital input (NPN & PNP) 16-channel digital output (NPN)
XX-HH00-C1NN	16-channel digital input (NPN & PNP) 16-channel digital output (PNP)
XX-S000-CNNN	32 digital inputs (NPN & PNP)
XX-0S00-N0NN	32 digital outputs (NPN)
XX-0S00-N1NN	32 digital outputs (PNP)

- Module parameter introduction

Technical Parameters	
model	XX-8800-C0NN
Product Name	8-channel digital input (NPN & PNP) 8-channel digital output (NPN)
Bus protocol	PROFINET, EtherCAT, CC-Link, DeviceNet CC-LinkIE Field Basic, CANopen
Rated input voltage	24V(18~36V)
Current consumption	38mA
Input channel parameters	
Number of input channels	8
Input signal type	NPN&PNP compatible (Transistor)
NPN Signal Level	0~5V
PNP Signal Level	15~30V
Current consumption per channel	5mA
Port protection	Overvoltage protection

Electrical isolation	AC500V
Output channel parameters	
Number of output channels	8
Input signal type	NPN(transistor)
Rated level	0V(Max: 1.5V)
Single channel rated current	Max: 0.5A (8The total current output by the channels is 2A)
Port protection	Overvoltage and overcurrent protection
Electrical isolation	AC500V
Physical parameters	
Dimensions	90mm×100mm×45.4mm
Operating temperature	-10~55℃
Storage temperature	-25~85℃
Relative humidity	95% non-condensing
Protection level	IP20

2.3.2 XX-8800-C1NN

Tip: XX represents the bus protocol to be selected (for example:PN、EC, CL, CI, CAetc.), the input and output parameters and external dimensions of the modules are consistent.

- XX-8800-C1NNIntegrated module model

model	Specifications
XX-8800-C0NN	8-channel digital input (NPN & PNP) 8-channel digital output (NPN)
XX-8800-C1NN	8-channel digital input (NPN & PNP) 8-channel digital output (PNP)
XX-8800-C2NN	8-channel digital input (NPN & PNP) 8-channel digital output (relay)
XX-HH00-C0NN	16-channel digital input (NPN & PNP) 16-channel digital output (NPN)
XX-HH00-C1NN	16-channel digital input (NPN & PNP) 16-channel digital output (PNP)
XX-S000-CNNN	32 digital inputs (NPN & PNP)
XX-0S00-N0NN	32 digital outputs (NPN)
XX-0S00-N1NN	32 digital outputs (PNP)

- Module parameter introduction

Technical Parameters	
model	XX-8800-C1NN
Product Name	8-channel digital input (NPN & PNP) 8-channel digital output (PNP)
Bus protocol	PROFINET, EtherCAT, CC-Link, DeviceNet CC-LinkIE Field Basic, CANopen
Rated input voltage	24V(18~36V)
Current consumption	38mA

Input channel parameters	
Number of input channels	8
Input signal type	NPN&PNP Compatible (Transistor)
NPN signal Level	0~5V
PNP signal Level	15~30V
Current consumption per channel	5mA
Port protection	Overvoltage protection
Electrical isolation	AC500V
Output channel parameters	
Number of output channels	8
Input signal type	PNP(transistor)
Rated level	24V(18~36V)
Single channel rated current	Max: 0.5A (8The total current output by the channels is 2A)
Port protection	Overvoltage and overcurrent protection
Electrical isolation	AC500V
Physical parameters	
Dimensions	90mm×100mm×45.4mm
Operating temperature	-10~55℃
Storage temperature	-25~85℃
Relative humidity	95% non-condensing
Protection level	IP20

2.3.3 XX-8800-C2NN

Tip: XX represents the bus protocol to be selected (for example:PN、EC, CL, CI, CAetc.), the input and output parameters and external dimensions of the modules are consistent.

- XX-8800-C2NNIntegrated module model

model	Specifications
XX-8800-C0NN	8-channel digital input (NPN & PNP) 8-channel digital output (NPN)
XX-8800-C1NN	8-channel digital input (NPN & PNP) 8-channel digital output (PNP)
XX-8800-C2NN	8-channel digital input (NPN & PNP) 8-channel digital output (relay)
XX-HH00-C0NN	16-channel digital input (NPN & PNP) 16-channel digital output (NPN)
XX-HH00-C1NN	16-channel digital input (NPN & PNP) 16-channel digital output (PNP)
XX-S000-CNNN	32 digital inputs (NPN & PNP)
XX-OS00-N0NN	32 digital outputs (NPN)
XX-OS00-N1NN	32 digital outputs (PNP)

● Module parameter introduction

Technical Parameters	
model	XX-8800-C2NN
Product Name	8-channel digital input (NPN & PNP) 8-channel digital output (relay)
Bus protocol	PROFINET, EtherCAT, CC-Link, DeviceNet CC-LinkIE Field Basic, CANopen
Rated input voltage	24V(18~36V)
Current consumption	38mA
Input channel parameters	
Number of input channels	8
Input signal type	NPN&PNPCompatible (Transistor)
NPN Signal Level	0~5V
PNP Signal Level	15~30V
Current consumption per channel	5mA
Port protection	Overvoltage protection
Electrical isolation	AC500V
Output channel parameters	
Number of output channels	8
Input signal type	Relay (normally open)
Rated level	240VAC/30VDC
Single channel rated current	5A
Port protection	Overvoltage and overcurrent protection
Electrical isolation	AC500V
Physical parameters	
Dimensions	90mm×100mm×45.4mm
Operating temperature	-10~55℃
Storage temperature	-25~85℃
Relative humidity	95% non-condensing
Protection level	IP20

2.3.4 XX-HH00-C0NN

Tip: XX represents the bus protocol to be selected (for example:PN、EC、CL、CI、CAetc.), the input and output parameters and external dimensions of the modules are consistent.

● XX-HH00-C0NN Integrated module model

model	Specifications
XX-8800-C0NN	8-channel digital input (NPN & PNP) 8-channel digital output (NPN)

XX-8800-C1NN	8-channel digital input (NPN & PNP) 8-channel digital output (PNP)
XX-8800-C2NN	8-channel digital input (NPN & PNP) 8-channel digital output (relay)
XX-HH00-C0NN	16-channel digital input (NPN & PNP) 16-channel digital output (NPN)
XX-HH00-C1NN	16-channel digital input (NPN & PNP) 16-channel digital output (PNP)
XX-S000-CNNN	32 digital inputs (NPN & PNP)
XX-OS00-N0NN	32 digital outputs (NPN)
XX-OS00-N1NN	32 digital outputs (PNP)

● Module parameter introduction

Technical Parameters	
model	XX-HH00-C0NN
Product Name	16-channel digital input (NPN & PNP) 16-channel digital output (NPN)
Bus protocol	PROFINET, EtherCAT, CC-Link, DeviceNet CC-LinkIE Field Basic, CANopen
Rated input voltage	24V(18~36V)
Current consumption	40mA
Input channel parameters	
Number of input channels	16
Input signal type	NPN&PNPCompatible (Transistor)
NPN Signal Level	0~5V
PNP Signal Level	15~30V
Current consumption per channel	5mA
Port protection	Overvoltage protection
Electrical isolation	AC500V
Output channel parameters	
Number of output channels	16
Input signal type	NPN(transistor)
Rated level	0V(Max: 1.5V)
Single channel rated current	Max: 0.5A (8The total current output by the channels is 2A)
Port protection	Overvoltage and overcurrent protection
Electrical isolation	AC500V
Physical parameters	
Dimensions	90mm×100mm×45.4mm
Operating temperature	-10~55℃
Storage temperature	-25~85℃
Relative humidity	95% non-condensing

Protection level	IP20
------------------	------

2.3.5 XX-HH00-C1NN

Tip: XX represents the bus protocol to be selected (for example:PN、 EC, CL,CI,CAetc.), the input and output parameters and external dimensions of the modules are consistent.

- XX-HH00-C1NNIntegrated module model

model	Specifications
XX-8800-C0NN	8-channel digital input (NPN & PNP) 8-channel digital output (NPN)
XX-8800-C1NN	8-channel digital input (NPN & PNP) 8-channel digital output (PNP)
XX-8800-C2NN	8-channel digital input (NPN & PNP) 8-channel digital output (relay)
XX-HH00-C0NN	16-channel digital input (NPN & PNP) 16-channel digital output (NPN)
XX-HH00-C1NN	16-channel digital input (NPN & PNP) 16-channel digital output (PNP)
XX-S000-CNNN	32 digital inputs (NPN & PNP)
XX-0S00-N0NN	32 digital outputs (NPN)
XX-0S00-N1NN	32 digital outputs (PNP)

- Module parameter introduction

Technical Parameters	
model	XX-HH00-C1NN
Product Name	16-channel digital input (NPN & PNP) 16-channel digital output (PNP)
Bus protocol	PROFINET, EtherCAT, CC-Link, DeviceNet CC-LinkIE Field Basic, CANopen
Rated input voltage	24V(18~36V)
Current consumption	40mA
Input channel parameters	
Number of input channels	16
Input signal type	NPN&PNPCompatible (Transistor)
NPNSignal Level	0~5V
PNPSignal Level	15~30V
Current consumption per channel	5mA
Port protection	Overvoltage protection
Electrical isolation	AC500V
Output channel parameters	
Number of output channels	16
Input signal type	PNP(transistor)
Rated level	24V(18~36V)
Single channel rated	Max: 0.5A (8The total current output by the channels is 2A)

current	
Port protection	Overvoltage and overcurrent protection
Electrical isolation	AC500V
Physical parameters	
Dimensions	90mm×100mm×45.4mm
Operating temperature	-10~55℃
Storage temperature	-25~85℃
Relative humidity	95% non-condensing
Protection level	IP20

2.3.6 XX-S000-CNNN

Tip: XX represents the bus protocol to be selected (for example:PN、EC, CL,CI,CAetc.), the input and output parameters and external dimensions of the modules are consistent.

- XX-S000-CNNNIntegrated module model

model	Specifications
XX-8800-C0NN	8-channel digital input (NPN & PNP) 8-channel digital output (NPN)
XX-8800-C1NN	8-channel digital input (NPN & PNP) 8-channel digital output (PNP)
XX-8800-C2NN	8-channel digital input (NPN & PNP) 8-channel digital output (relay)
XX-HH00-C0NN	16-channel digital input (NPN & PNP) 16-channel digital output (NPN)
XX-HH00-C1NN	16-channel digital input (NPN & PNP) 16-channel digital output (PNP)
XX-S000-CNNN	32 digital inputs (NPN & PNP)
XX-0S00-N0NN	32 digital outputs (NPN)
XX-0S00-N1NN	32 digital outputs (PNP)

- Module parameter introduction

Technical Parameters	
model	XX-HH00-C0NN
Product Name	32 digital inputs (NPN & PNP)
Bus protocol	PROFINET, EtherCAT, CC-Link, DeviceNet CC-LinkIE Field Basic, CANopen
Rated input voltage	24V(18~36V)
Current consumption	40mA
Input channel parameters	
Number of input channels	32
Input signal type	NPN&PNPCompatible (Transistor)
NPNSignal Level	0~5V
PNPSignal Level	15~30V
Current consumption	5mA

per channel	
Port protection	Overvoltage protection
Electrical isolation	AC500V
Physical parameters	
Dimensions	90mm×100mm×45.4mm
Operating temperature	-10~55℃
Storage temperature	-25~85℃
Relative humidity	95% non-condensing
Protection level	IP20

2.3.7 XX-0S00-N0NN

Tip: XX represents the bus protocol to be selected (for example:PN、EC, CL,CI,CAetc.), the input and output parameters and external dimensions of the modules are consistent.

- XX-0S00-N0NNIntegrated module model

model	Specifications
XX-8800-C0NN	8-channel digital input (NPN & PNP) 8-channel digital output (NPN)
XX-8800-C1NN	8-channel digital input (NPN & PNP) 8-channel digital output (PNP)
XX-8800-C2NN	8-channel digital input (NPN & PNP) 8-channel digital output (relay)
XX-HH00-C0NN	16-channel digital input (NPN & PNP) 16-channel digital output (NPN)
XX-HH00-C1NN	16-channel digital input (NPN & PNP) 16-channel digital output (PNP)
XX-S000-CNNN	32 digital inputs (NPN & PNP)
XX-0S00-N0NN	32 digital outputs (NPN)
XX-0S00-N1NN	32 digital outputs (PNP)

- Module parameter introduction

Technical Parameters	
model	XX-0S00-N0NN
Product Name	32 digital outputs (NPN)
Bus protocol	PROFINET, EtherCAT, CC-Link, DeviceNet CC-LinkIE Field Basic, CANopen
Rated input voltage	24V(18~36V)
Current consumption	40mA
Output channel parameters	
Number of output channels	32
Input signal type	NPN(transistor)
Rated level	0V(Max: 1.5V)
Single channel rated current	Max: 0.5A (8The total current output by the channels is 2A)
Port protection	Overvoltage and overcurrent protection

Electrical isolation	AC500V
Physical parameters	
Dimensions	90mm×100mm×45.4mm
Operating temperature	-10~55℃
Storage temperature	-25~85℃
Relative humidity	95% non-condensing
Protection level	IP20

2.3.8 XX-0S00-N1NN

Tip: XX represents the bus protocol to be selected (for example:PN、EC, CL,CI,CAetc.), the input and output parameters and external dimensions of the modules are consistent.

- XX-HH00-C1NNIntegrated module model

model	Specifications
XX-8800-C0NN	8-channel digital input (NPN & PNP) 8-channel digital output (NPN)
XX-8800-C1NN	8-channel digital input (NPN & PNP) 8-channel digital output (PNP)
XX-8800-C2NN	8-channel digital input (NPN & PNP) 8-channel digital output (relay)
XX-HH00-C0NN	16-channel digital input (NPN & PNP) 16-channel digital output (NPN)
XX-HH00-C1NN	16-channel digital input (NPN & PNP) 16-channel digital output (PNP)
XX-S000-CNNN	32 digital inputs (NPN & PNP)
XX-0S00-N0NN	32 digital outputs (NPN)
XX-0S00-N1NN	32 digital outputs (PNP)

- Module parameter introduction

Technical Parameters	
model	XX-0S00-N1NN
Product Name	32 digital outputs (PNP)
Bus protocol	PROFINET, EtherCAT, CC-Link, DeviceNet CC-LinkIE Field Basic, CANopen
Rated input voltage	24V(18~36V)
Current consumption	40mA
Output channel parameters	
Number of output channels	32
Input signal type	PNP(transistor)
Rated level	24V(18~36V)
Single channel rated current	Max: 0.5A (8The total current output by the channels is 2A)
Port protection	Overvoltage and overcurrent protection
Electrical isolation	AC500V

Physical parameters	
Dimensions	90mm×100mm×45.4mm
Operating temperature	-10~55℃
Storage temperature	-25~85℃
Relative humidity	95% non-condensing
Protection level	IP20

3.Module Installation

3.1 Basics

FS protection level of the series modules is IP20, which means that FSThe series modules can only be installed on rails, control cabinets or electrical operating rooms and in dry environments (protection levelIP20). Safety protection must be provided in cabinets, control cabinets or operating rooms to prevent electric shock and fire spread.

FS series modules can be mounted on mounting rails in accordance with EN 60715 (35×7.5 mm or 35×15 mm). In the control cabinet, separate grounding of the mounting rail is required. Exception: If the rail is mounted on a grounded galvanized mounting plate, separate grounding of the rail is not required.

3.2 Installation clearance

When installing and removing FS series modules, a minimum clearance must be maintained, as shown in Figure 3-1.

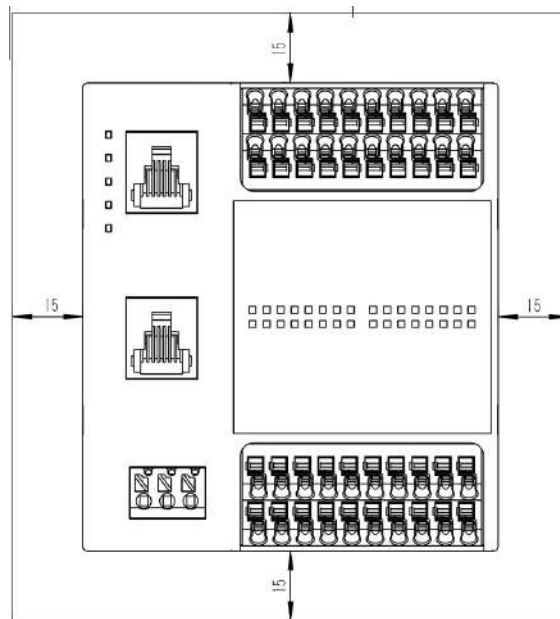

Figure 3-1Minimum installation clearance

3.3 IO Module installation and removal

3.3.1 IO Module Installation

1. First, pull out the rail clip under the module with a flat-blade screwdriver;
2. Hang the module on DIN35On the rail, use a flat-blade screwdriver to push the rail clip at the bottom into place and lock it, as shown in Figure 3-2 shown.

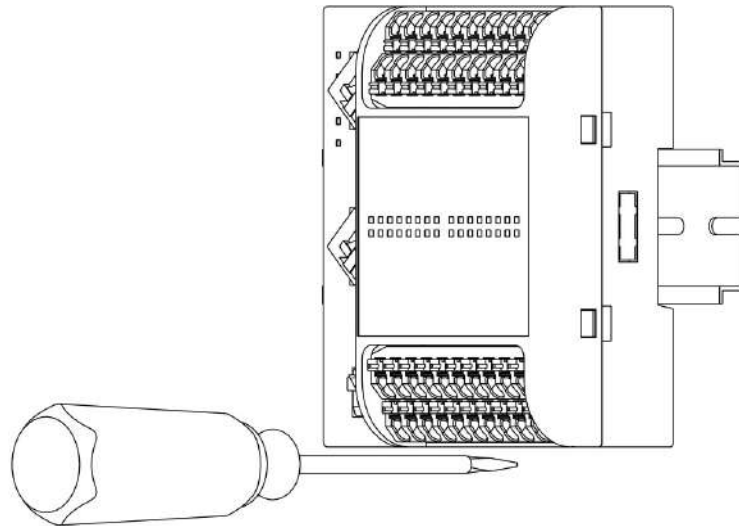

Figure 3-2 Module Installation

3.3.2 IO Module removal

1. First, pull out the rail clip under the module with a flat-blade screwdriver;
2. Gently pull the module out and the guide rail forms an angle, and then pushes the module out of the net, as shown in Figure 3-3 shown.

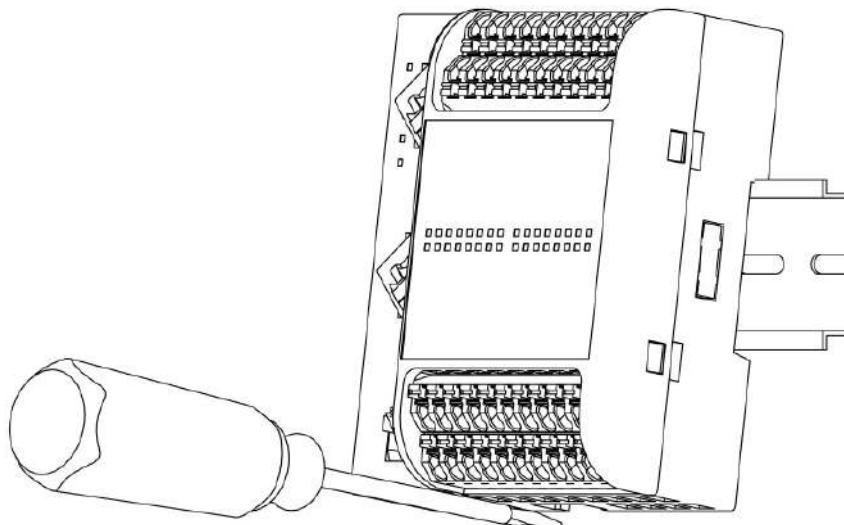

Figure 3-3 Module removal

4. Dimensions and Wiring Diagram

4.1 Module Dimensions

FS dimensions of all modules in the series are consistent, that is, the length, width and height are equal.

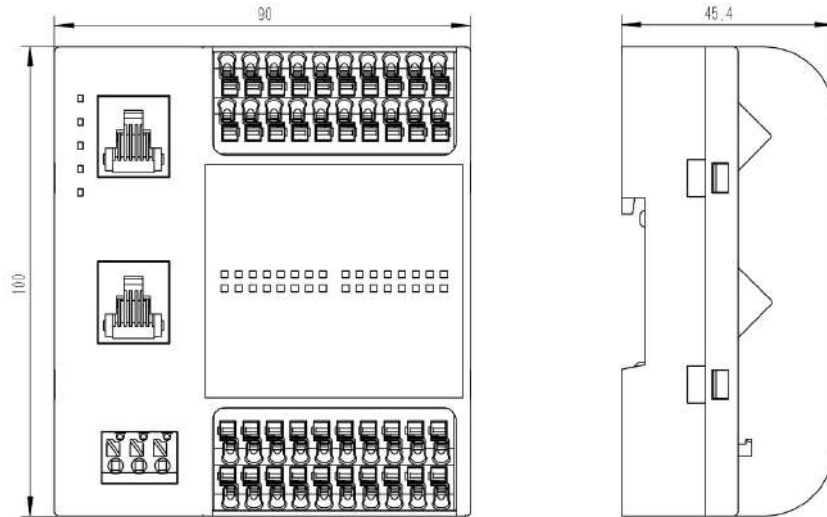

Figure 4-1 Module Dimensions

4.2 Module power wiring diagram

The power wiring diagram for EtherCAT, PROFINET, CC-Link, and CC-Link IE Field Basic remote I/O modules in the FS series is shown in Figure 4-3.

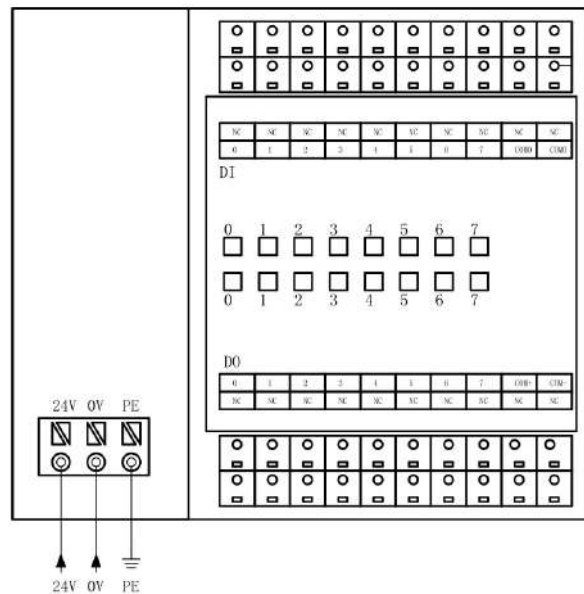

Figure 4-3 Power wiring diagram

The wiring diagram of the DeviceNet remote I/O module in the FS series differs from that

of modules using other bus protocols, as shown in Figure 4-4.

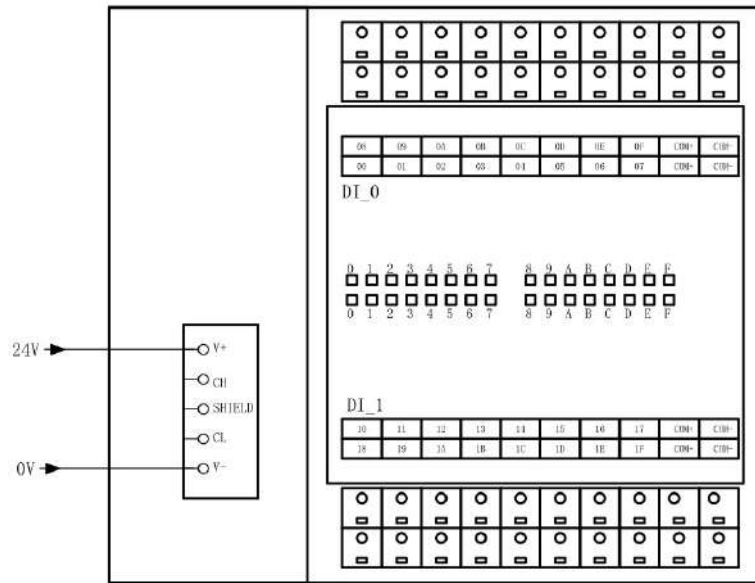

Figure 4-4 Power wiring diagram

4.3 Digital input channel wiring diagram

In the FS series remote I/O modules, all input channels support both NPN and PNP signal types; however, only one type—either NPN or PNP—can be used during operation.

4.3.1 Digital input channel NPN Signal wiring diagram

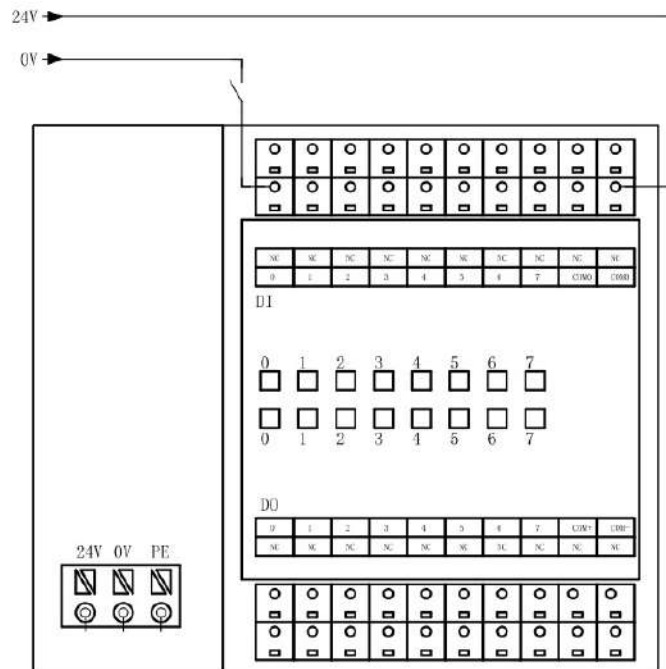

Figure 4-5 Digital input channels NPN connection

4.4.2 Digital output PNP Wiring Diagram

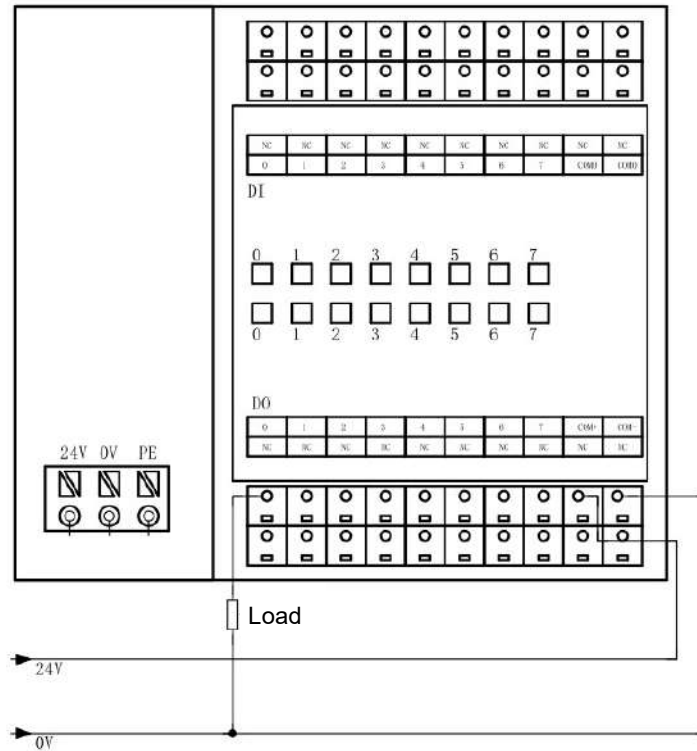

Figure 4-6 Digital output channels PNP connection

4.5 Relay output wiring diagram

4.5.1 Relay output DC load wiring diagram

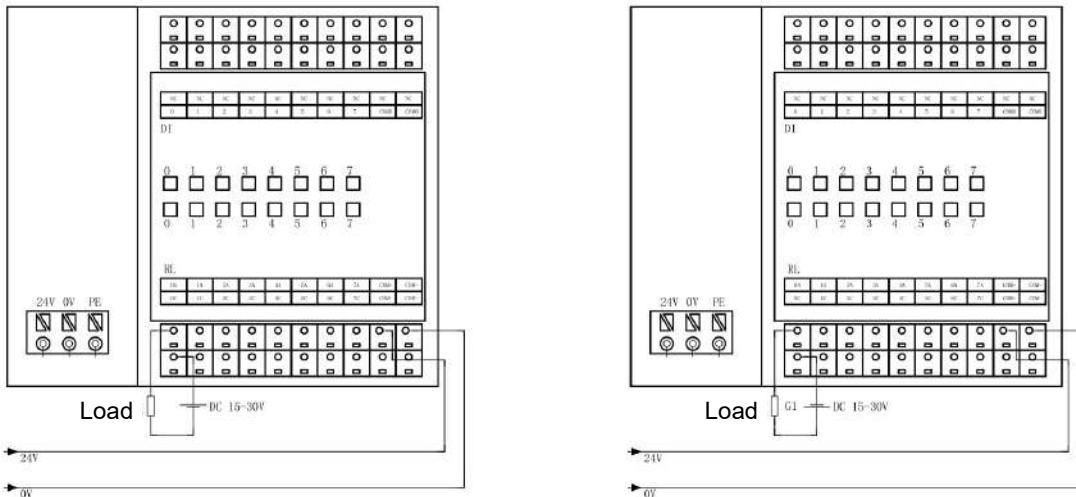

Figure 4-7 Relay output DC load wiring diagram

4.5.2 Relay output AC load wiring diagram

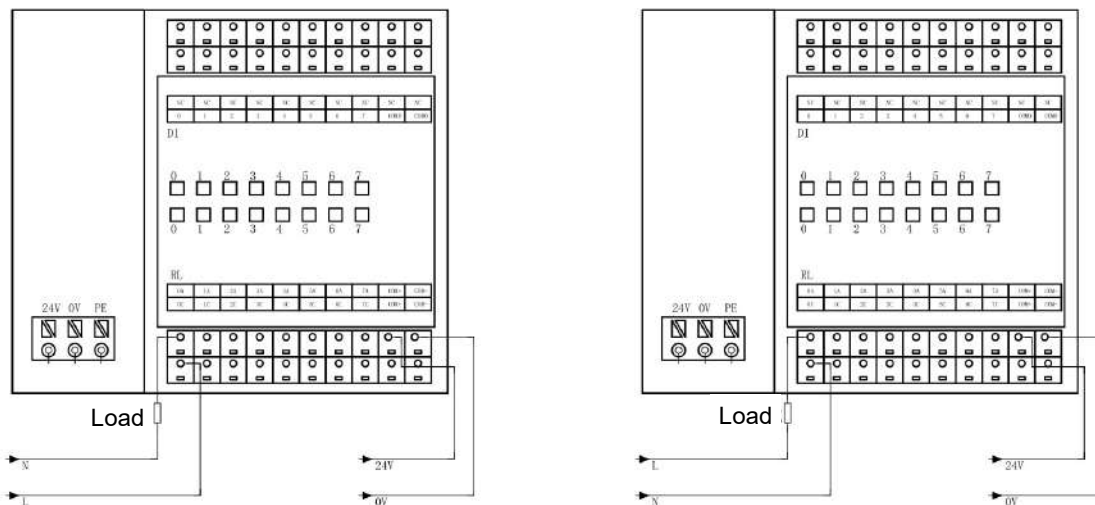

Figure 4-8 Relay output AC load wiring diagram

5.FS Series IO configuration

This chapter mainly introduces the connection and configuration of FS series remote I/O modules with mainstream industrial PLC, including configuration in the programming software and parameter settings of certain modules.

5.1 EtherCAT Protocol

5.1.1 TwinCAT3 and EtherCAT Protocol IO Module connections and configuration

1. Communication connection diagram, as shown in Figure 5-1-1 shown.

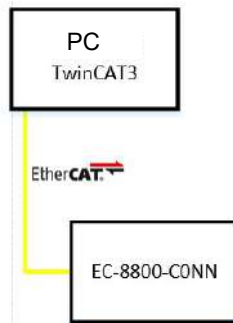

Figure 5-1-1 Communication connection diagram

2. Hardware configuration as shown in Table 5-1-2 Shown

Table 5-1-2 Hardware Configuration Table

Hardware	Quantity	Remark
Programming Computer	1	InstallTwinCAT3
EC-8800-C0NN	1	EtherCAT protocol 8DI/8DO Modules
Network cable	several	

3, Install XML Description File

Installing XML description files into TwinCAT3As shown in Figure 5-1-3The default folder for this example is (C:\TwinCAT\3.1\Config\Io\EtherCAT)

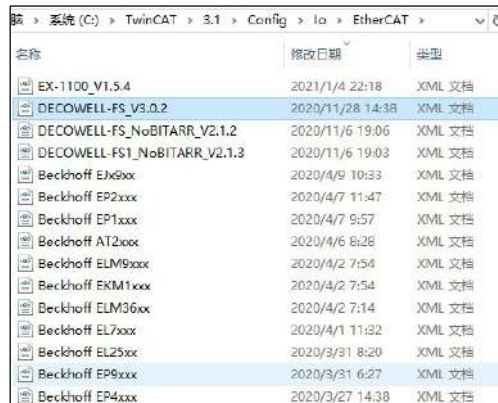

Figure 5-1-3 Install XML Description File

4. New project and equipment configuration

Open TwinCAT3In the software, select "File" > New > Project from the menu bar, as shown in Figure 5-1-4As shown, in the New Project window, select "TwinCATprojects", as shown in Figure 5-1-5shown.

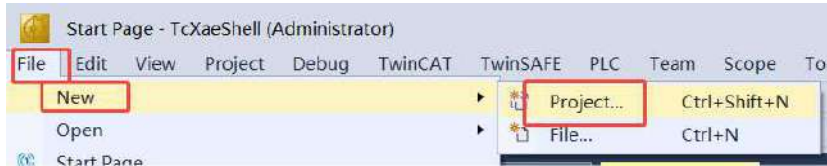

Figure 5-1-4New Project

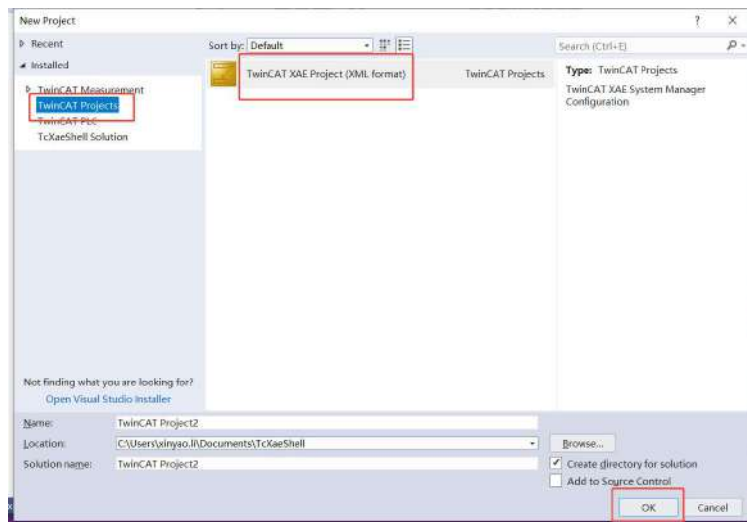

Figure 5-1-5Select TwinCATproject

I connected to the programming computerOScan to the project, click "I/O">"Devices">"Scan", as shown in Figure 5-1-6As shown, the scanned hardware configuration is shown in Figure 5-1-7shown.

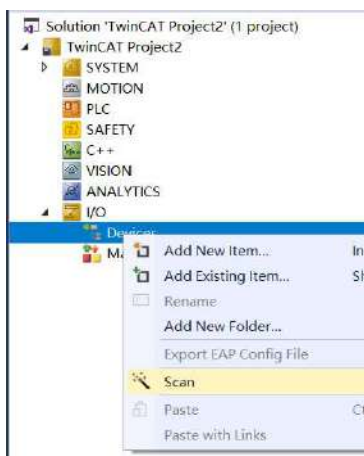

Figure 5-1-6 Scan IO device

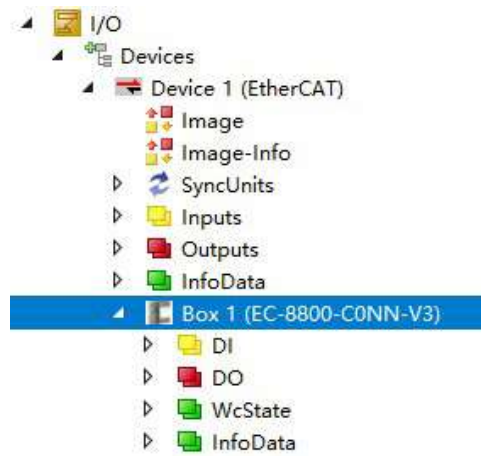

Figure 5-1-7 Hardware Configuration

5.1.2 CODESYS and EtherCAT Protocol IO Module connections and configuration

1. Communication connection diagram, as shown in Figure 5-1-8shown.

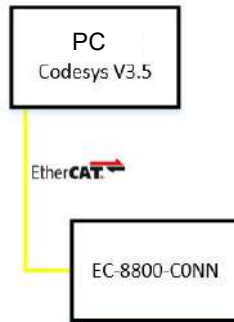

Figure 5-1-8Communication connection diagram

2. Hardware configuration as shown in Table 5-1-2Shown

Table 5-1-2Hardware Configuration Table

hardware	quantity	Remark
Programming Computer	1	InstallCodesysV3.5
EC-8800-C0NN	1	EtherCAT protocol 8DI/8DOModules
Network cable	several	

3. Install XML Description File

Open CODESYS V3.5In the software, select "Tools" > "Device Repository" from the menu bar, as shown in Figure 5-1-9shown.

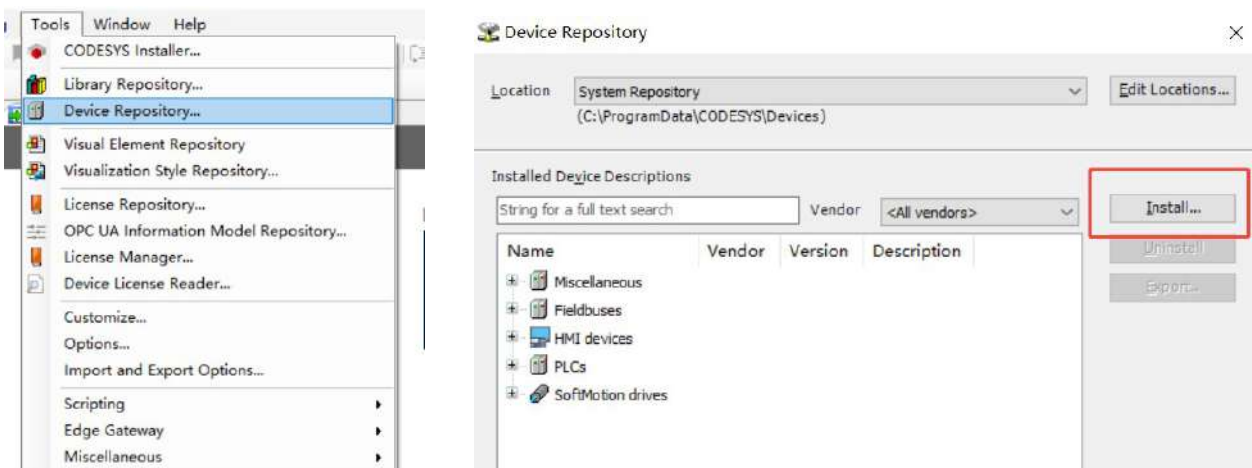

Figure 5-1-9Install XML Device Description File

4. New project and equipment configuration

Open CODESYS V3.5Software, select New Project > Project > Standard project", as shown in Figure 5-1-10shown.

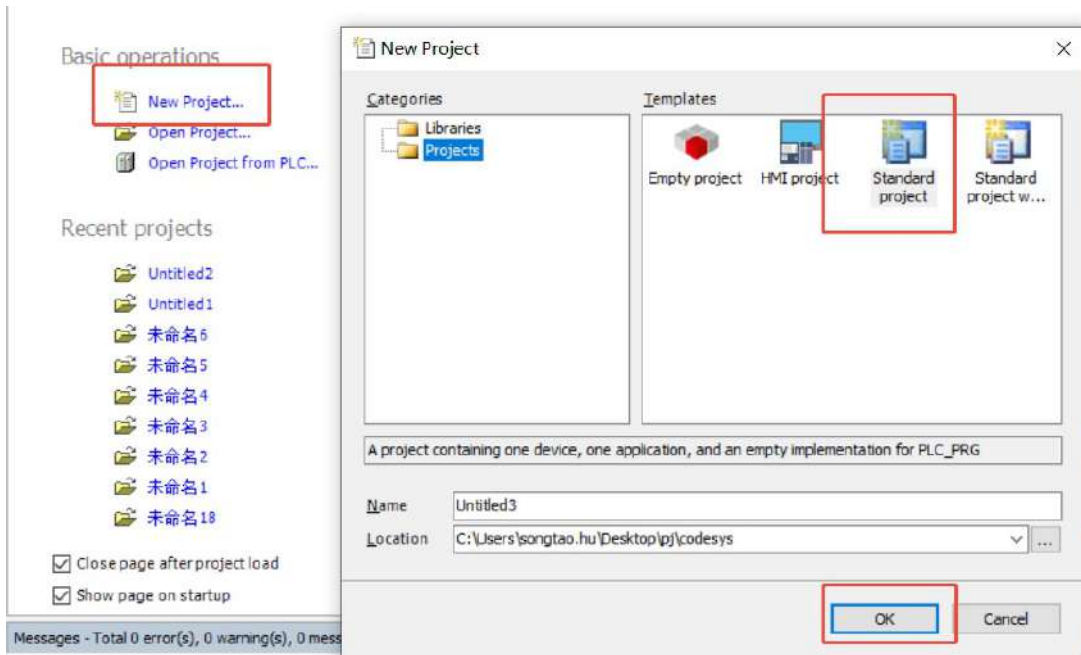

Figure 5-1-10New Construction

In the standard project window, select "CODESYS SoftMotionWinV3",PLC_PRGSelect "Structured Text (ST)", as shown in Figure 5-1-11shown.

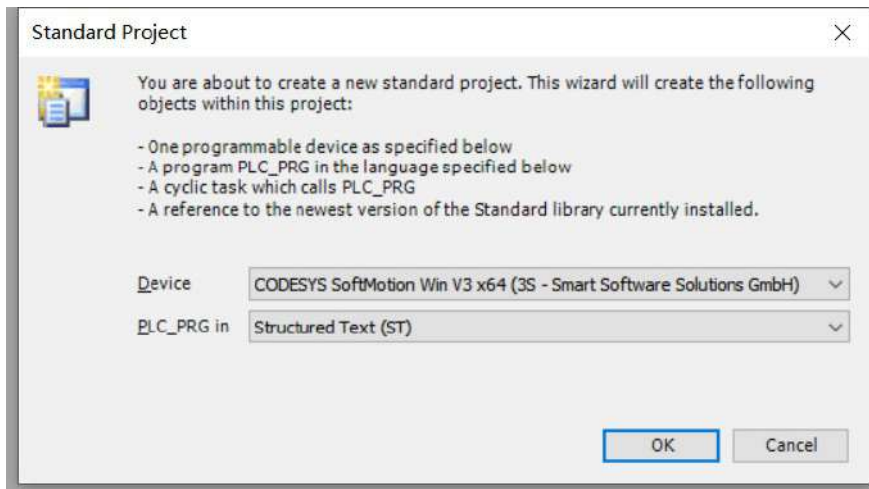

Figure 5-1-11Select device and programming language

Tip: Softmotion can drive and I/O, Control can only take I/OBut not with drive.

In the device tree, "Device (CODESYS SoftMotionWinV3)">"Add device", as shown in Figure 5-1-12As shown, in the Add Device window, select Fieldbus > EtherCAT">EtherCAT Master", as shown in Figure 5-1-13 shown.



Figure 5-1-12 Add a device

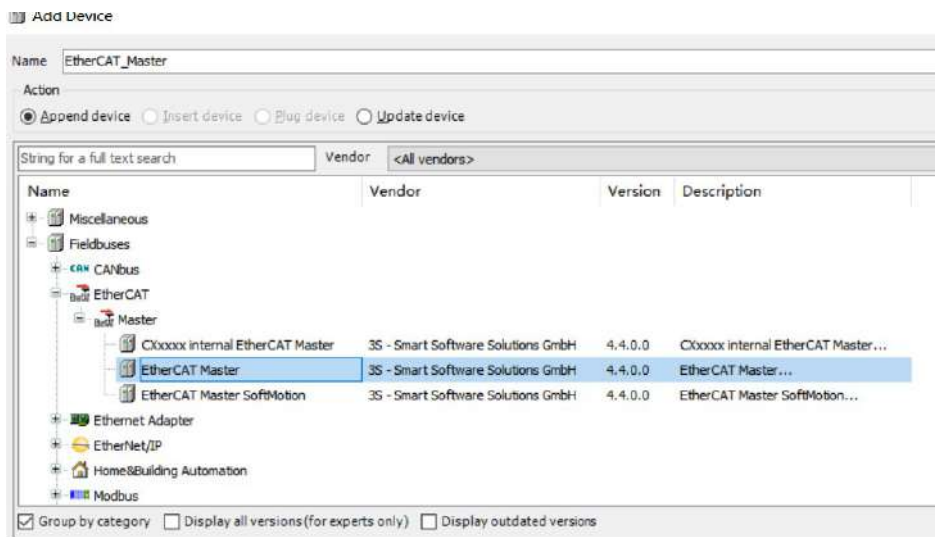

Figure 5-1-13 Choose EtherCAT bus

For EtherCAT Master allocates the network port, double-click "EtherCAT_Master"> "EtherCAT NICSettings > Browse, as shown in Figure 5-1-14 shown.

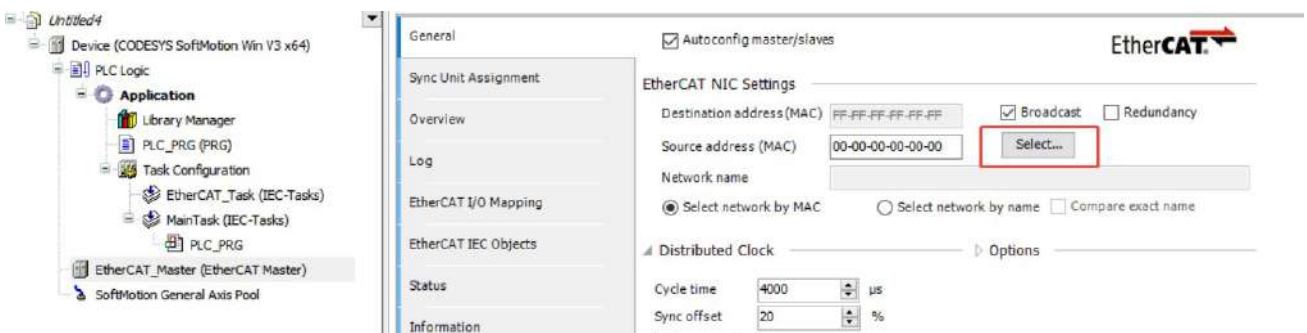

Figure 5-1-14 Assign network port

Tip: Before assigning the network port, you need to download the project to the controller

Manually IO Add the module to the device tree, right-click "EtherCAT Master">"Add Device", select "EC-8800-C0NN", as shown in Figure 5-1-15 shown.

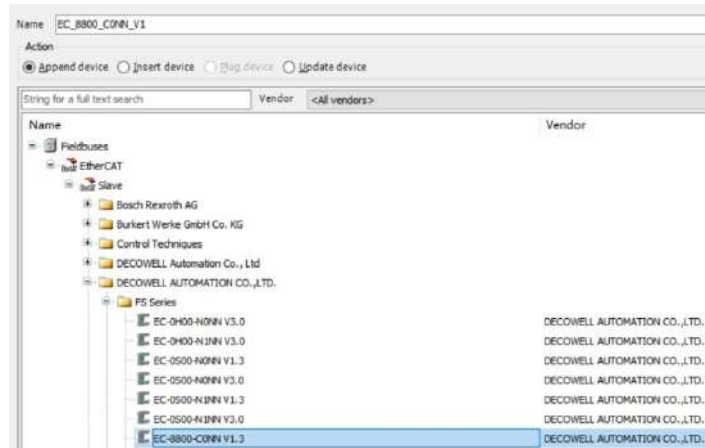

Figure 5-1-15 Add the module to the device tree

5. Download and monitor the program

Select "Online" > "Login to" from the menu bar, Confirm the download, then start the program and select "Debug" > "Start" in the menu bar.

5.1.3 Sysmac Studio and EtherCAT Protocol I/O Module

1. Communication connection diagram, as shown in Figure 5-1-16 shown.

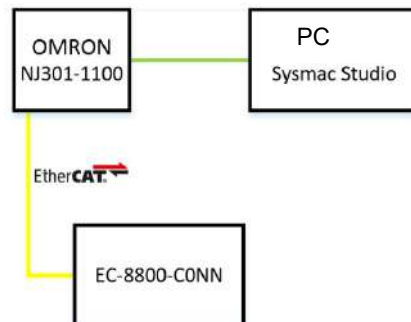

Figure 5-1-16 Communication connection diagram

2. Hardware configuration is shown in Table 5-1-3 Shown

Table 5-1-3 Hardware Configuration Table

Hardware	Quantity	Remark
Programming Computer	1	Sysmac Studio
Controller	1	NJN301-1100
EC-8800-C0NN	1	EtherCAT protocol 8DI/8DO Modules
Network cable	several	

3. New project and equipment configuration

Open Sysmac Studio, select "New Project" and configure the device model and version number, as shown in Figure 5-1-18 shown.

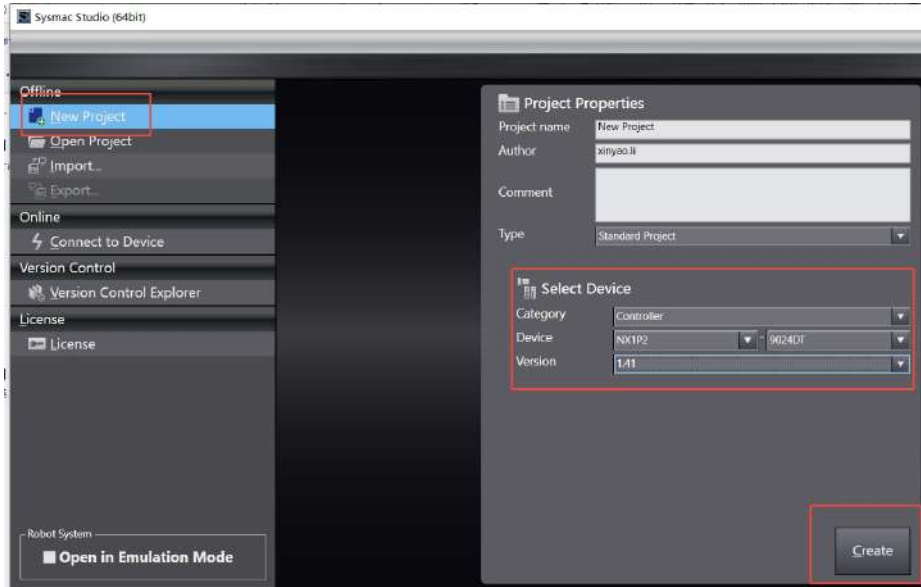

Figure 5-1-17 New Construction

4. Install XML Description File

As shown in Figure 5-1-17 Open Sysmac Studio's ESI library, click "Install (file)", Select the XML file and confirm, then wait for the installation to complete.

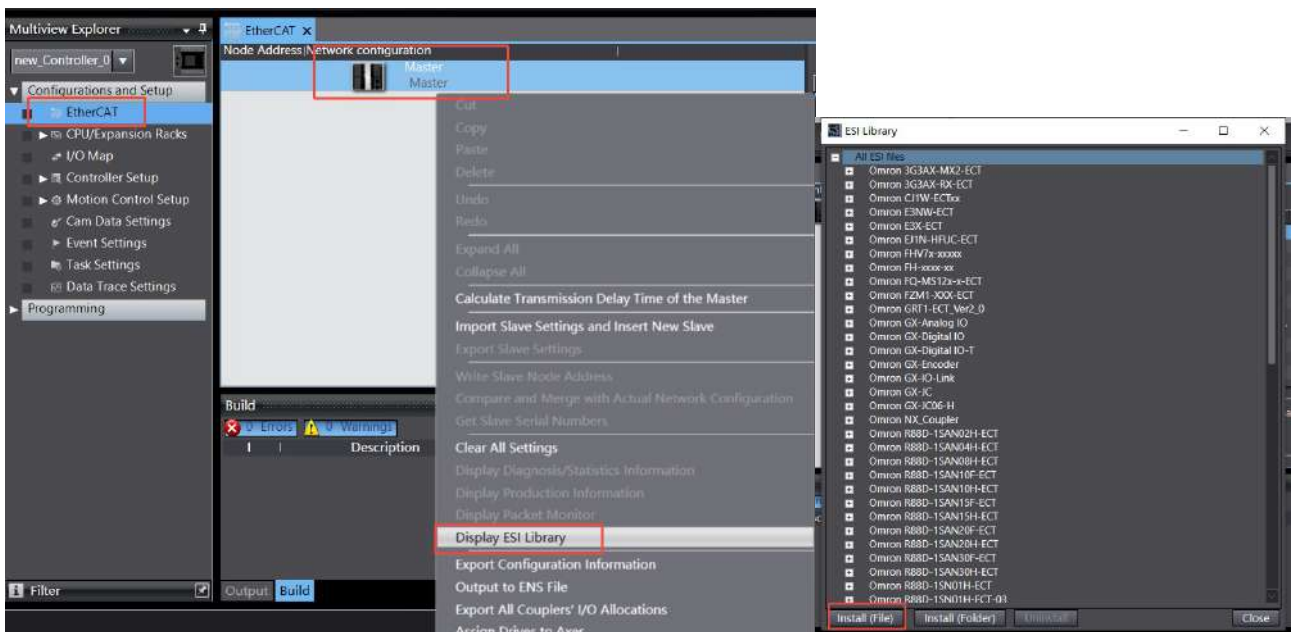

Figure 5-1-18 Display ESI library

To add an adapter, double-click "EtherCAT" in the Multiview Explorer, select "FS Series" in the Toolbox, and then select "EC-8800-C0NN-V3" at the bottom of the Toolbox, as shown in Figure 5-1-19.

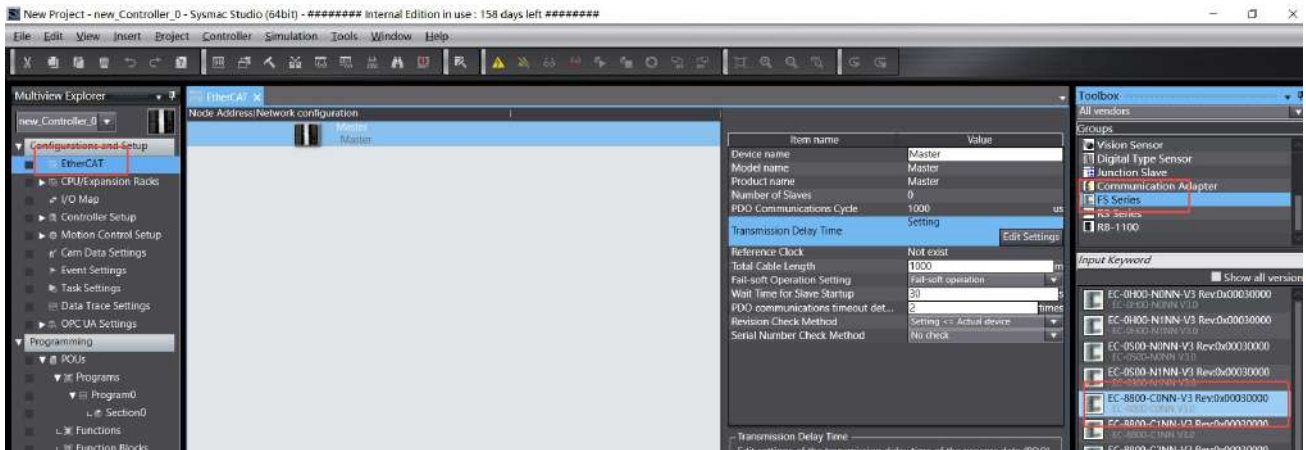

Figure 5-1-19 Adding Modules

Click the online icon, right-click the mouse on the icon of the master device, and select Write Slave Device Node Address (the default node of the WELL-LINK EtherCAT slave device is 0, so the node number must be set), as shown in Figure 5-1-20 shown.

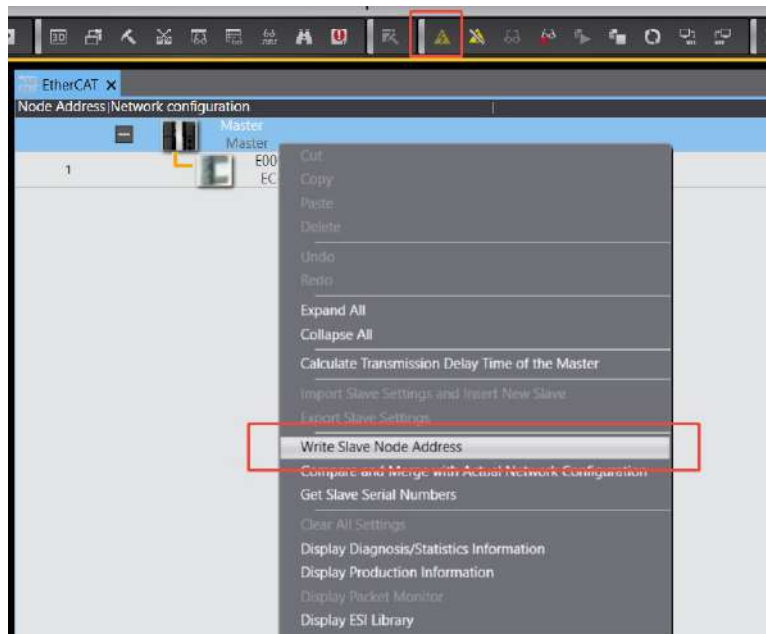

Figure 5-1-20 Node address write

Note: After writing the node address, the device needs to be restarted for the node address to take effect.

After the device restarts, download the program to the controller. Select "Controller" > "Transfer" > "Transfer to Controller (T)" in the menu bar, as shown in Figure 5-twenty one as shown, and execute the download.

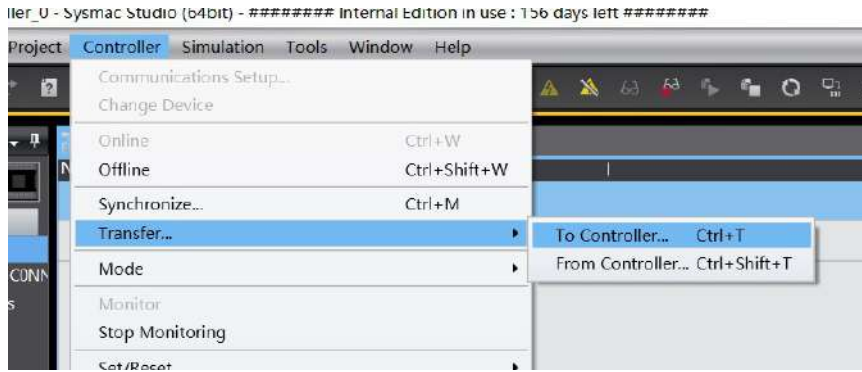

Figure 5-1-21 Program Download

5.2 PROFINET Protocol

5.2.1 TIA Portal and PROFINET Protocol IO Module connections and configuration

1. Communication connection diagram, as shown in the figure 5-2-1 shown.

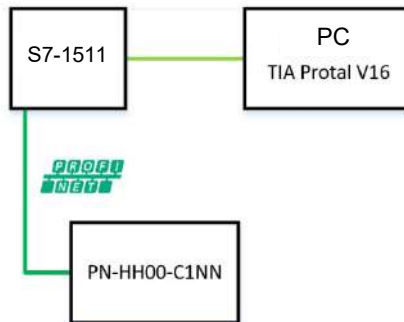

Figure 5-2-1 Communication connection diagram

2. Hardware configuration as shown in the table 5-2-1 shown

Table 5-2-1 Hardware Configuration Table

Hardware	Quantity	Remark
Programming Computer	1	Install TIA Portal V16
Controller	1	S7-1511
PN-HH00-C1NN	1	PROFINET16DI/16DO Modules
Network cable	several	

3. Installation GSD document

Open TIA Portal V16, select "Options" > "Support Device Description Files (GSD)", as shown in the figure 5-2-2 shown.

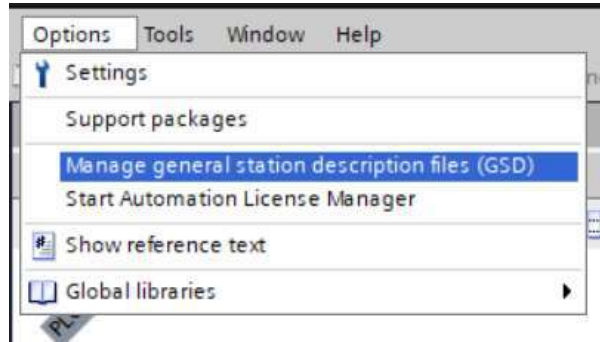

Figure 5-2-2 Install GSD document

4. New project and equipment configuration

Open TIA Portal V16, select New Project and configure, as shown in the figure5-2-3.

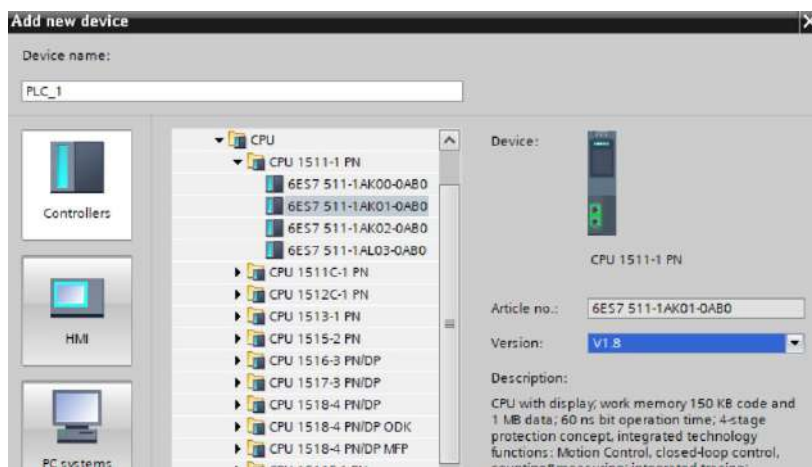

Figure 5-2-3 New Construction

Configure the device, switch to the network view window, expand the hardware directory on the right, and select PN-HH00-C1NNDrag it to the network view, as shown in the figure5-2-4shown.

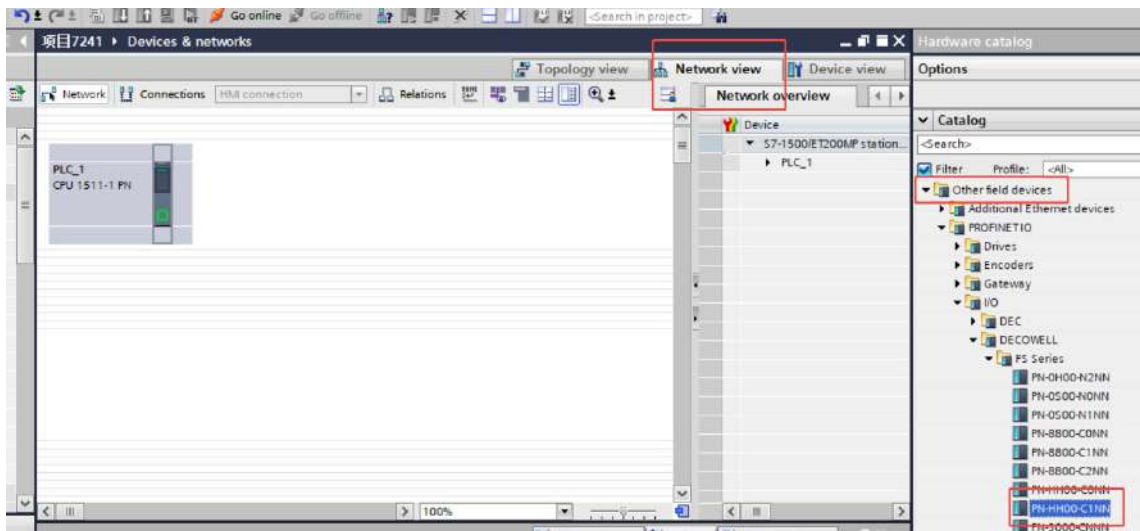

Figure 5-2-4 Configuring the device

In the network view for remote IO module assignment controller, mouse click IO in the module "Not assigned", select PLC_1.PROFINET interface_1, as shown in the figure5-2-5shown.

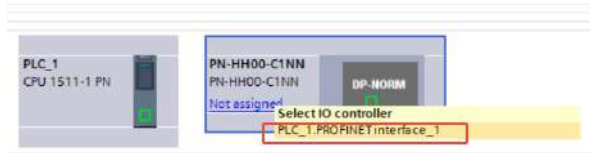

Figure 5-2-5Allocation IO Controller

Setting I/O Module IP Address, in the device view, double-click the module to enter the property view, as shown in the figure5-2-6shown.

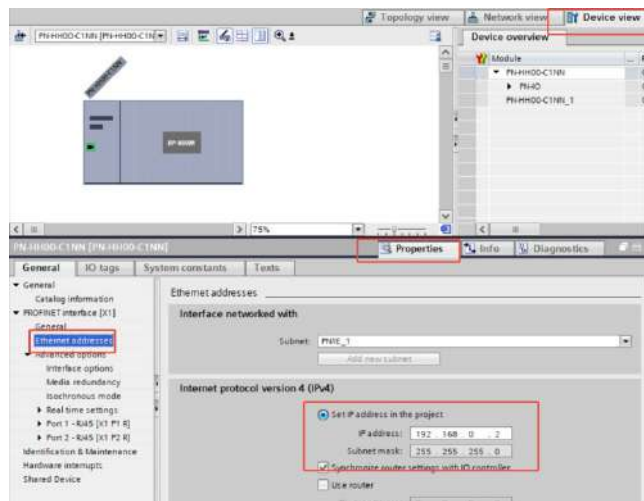

Figure 5-2-6Allocation IP address

remoteAssign device names to I/O modules. Right-click the module and select "Assign device name" as shown in Figure 5-2-7. Select the interface type and update the list and assign a name as shown in Figure 5-2-8.

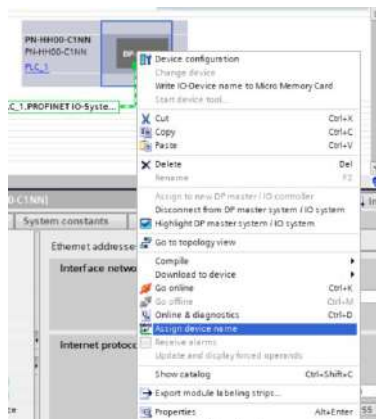

Figure 5-2-7 Assigning a Device Name

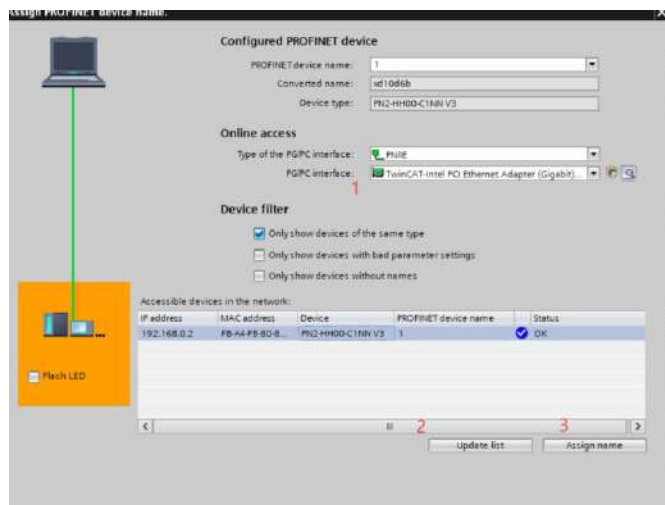

Figure 5-2-8 Write device name

Select all devices in the network view and download, as shown in the figure5-2-9As shown, after the program is downloaded, start CPURun and switch to online monitoring to see if the communication is normal, as shown in the figure5-2-10shown.

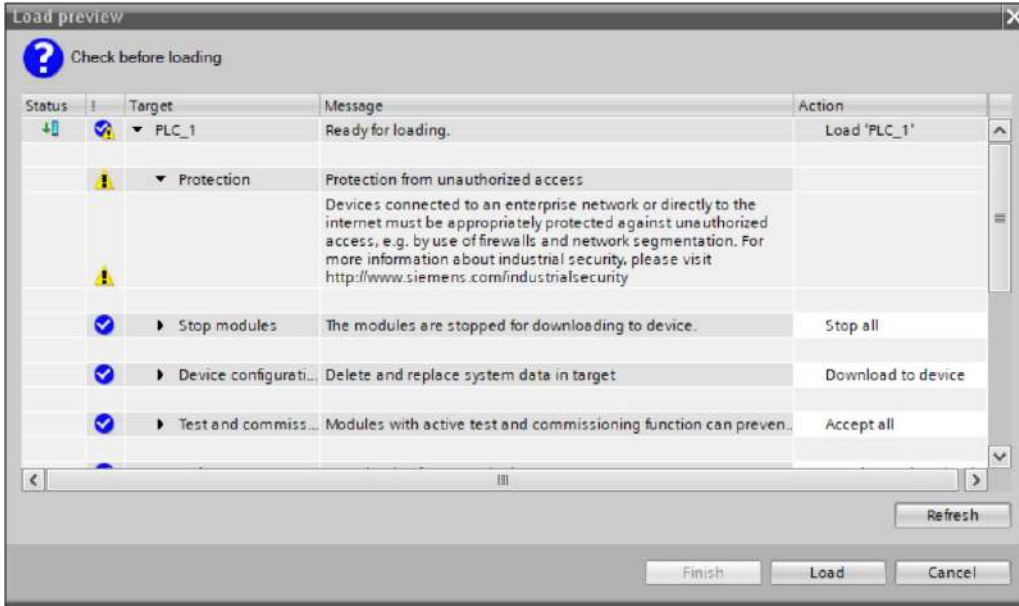

Figure 5-2-10Program Download

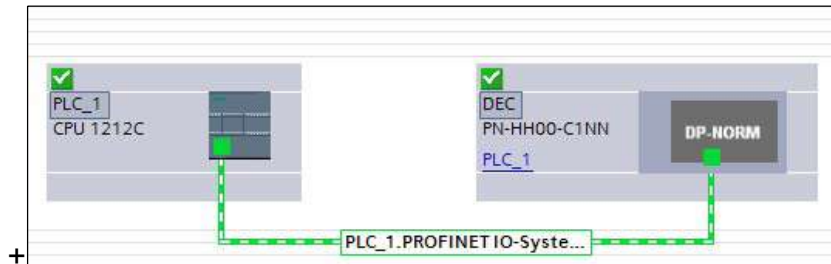

Figure 5-2-11Equipment Monitoring

5.2.2 Step7 Smart and PROFINET protocol IO moduleConnection and configuration

1. Communication connection diagram, as shown in the figure5-2-12shown.

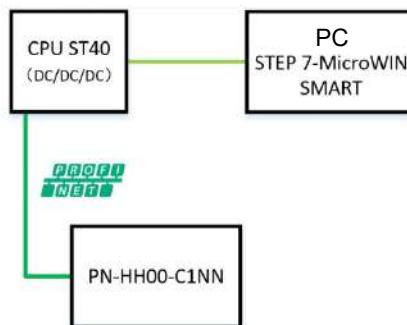

Figure 5-2-12Communication connection diagram

2. Hardware configuration as shown in the table5-2-2Shown

Table 5-2-2 Hardware Configuration Table

Hardware	Quantity	Remark
Programming Computer	1	InstallSTEP7-MicroWIN SMART
Controller	1	CPU ST40(DC/DC/DC)
PN-HH00-C1NN	1	PROFINETprotocol16DI/16DOModules
Network cable	several	

3. Install GSD document

OpenSTEP7-MicroWIN SMART, select "GSDML Management", as shown in the figure5-2-13shown.

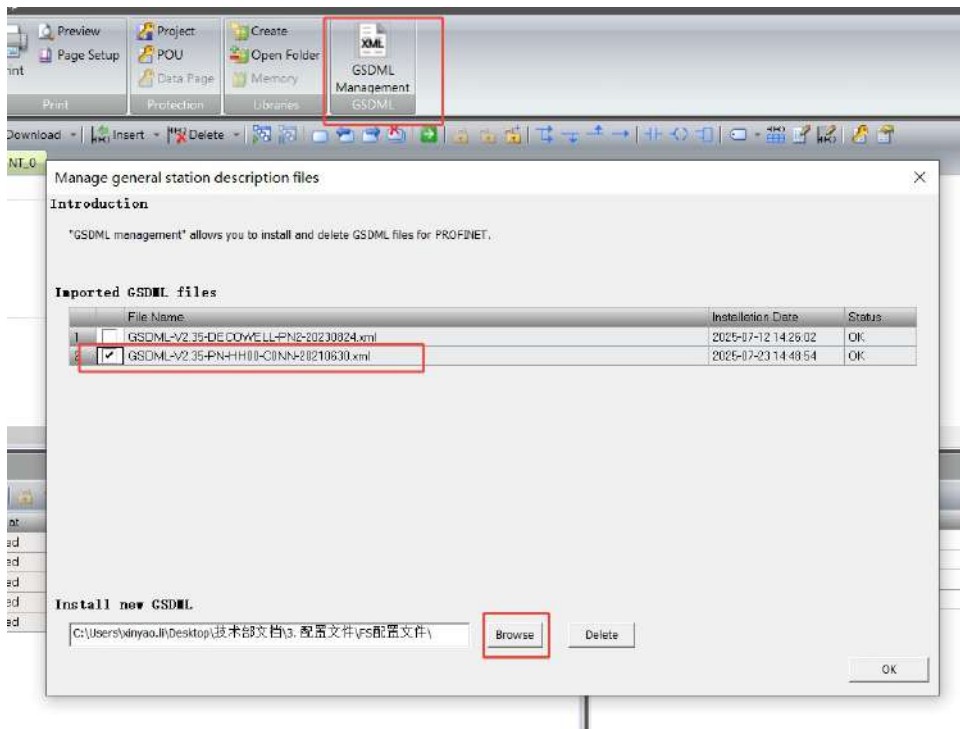

Figure 5-2-13Install GSD document

4. Assign device name

In the menu bar, select "Tools" > "Find PROFINET Devices". In the window that appears, select the network card connected to the module and search for devices. Select the module from the network and edit its device name, as shown in Figure 5-2-14.

Notice:

- ① When selecting a network card, two options will appear for the same network card, as

shown in the figure below. Here, select the network card without Auto.



②After assigning the device name, make sure that the device name used when configuring the IO module is exactly the same as the one assigned above; otherwise, the PLC will not be able to communicate properly with the IO module.

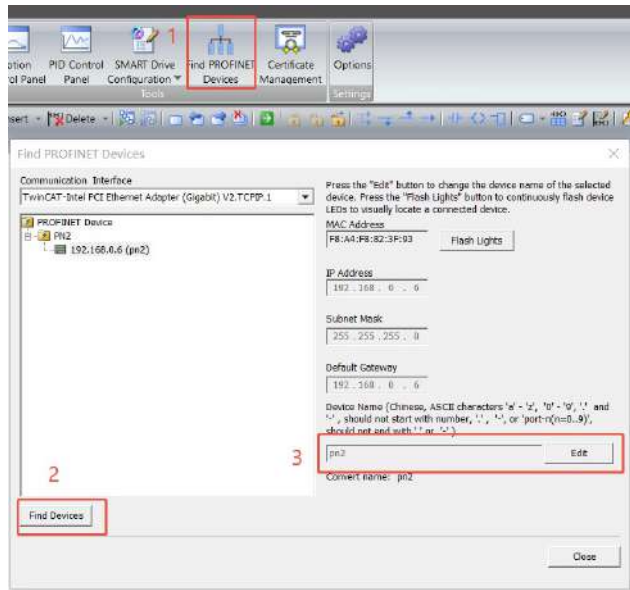

Figure 5-2-14Assigning a Device Name

5. New Project and Equipment Configuration

From the menu bar, select Tools > PROFINET”, select PLCThe role is the controller, as shown in the figure5-2-15As shown, add IOmodule and assign a device name (which must be the same as the device name assigned in step 4 above) andPAddress and confirm the generation, as shown in the figure5-2-16shown.

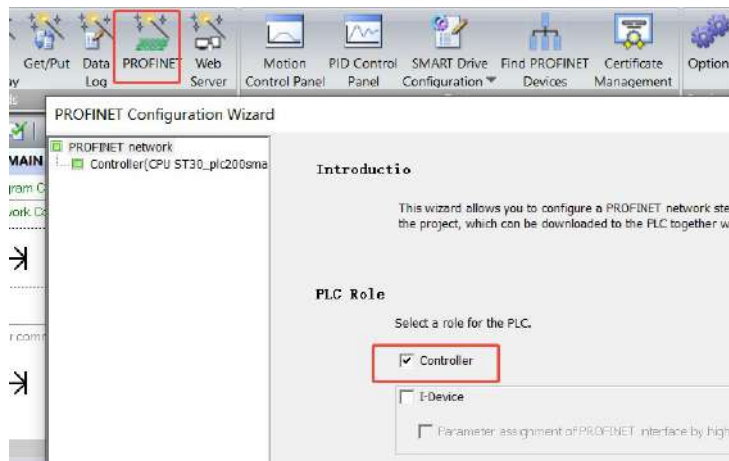

Figure 5-2-15Select PLC Role

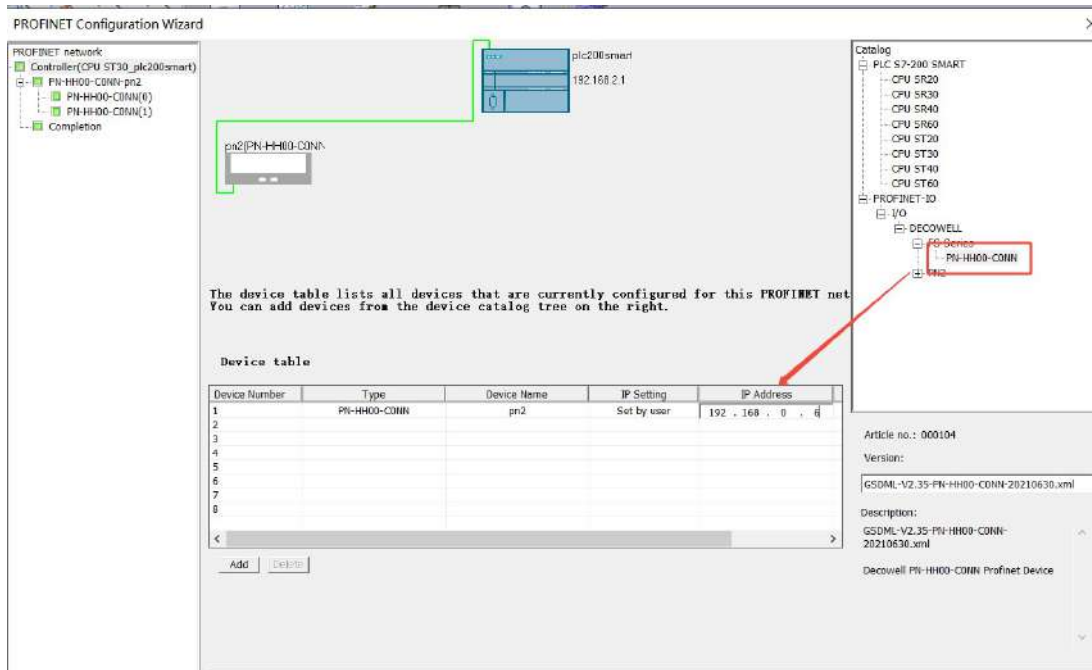

Figure 5-2-16 Assign a device name and IP address

6、 Program download

In the menu bar, select "PLC" > "Download", then in the communication window, choose "Find CPU". Select the PLC to which you want to download the program, and proceed with the download.

Note: When using STEP 7-MicroWIN SMART to configure PROFINET communication for the S7-200 SMART, the CPU firmware version must be \geq V2.4. For firmware version V2.3, an online firmware upgrade is supported. However, for firmware versions below V2.3, the firmware must be updated using a memory card inserted into the CPU.

5.2.3 CODESYS and PROFINET protocol IO module Connection and configuration

1. Communication connection diagram, as shown in the figure 5-2-17 shown.

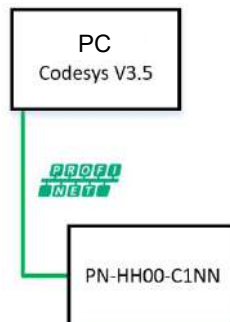

Figure 5-2-17 Communication connection diagram.

2. Hardware configuration as shown in the table5-2-4Shown

surface5-2-4Hardware Configuration Table

hardware	quantity	Remark
Programming Computer	1	InstallCodesysV3.5
PN-HH00-C1NN	1	PROFINETprotocol16DI/16DOModules
Network cable	several	

2. Install GSDdocument

Open CODESYS V3.5Software, select "Tools" > "Device Repository" from the menu bar, as shown in the figure5-2-18shown.

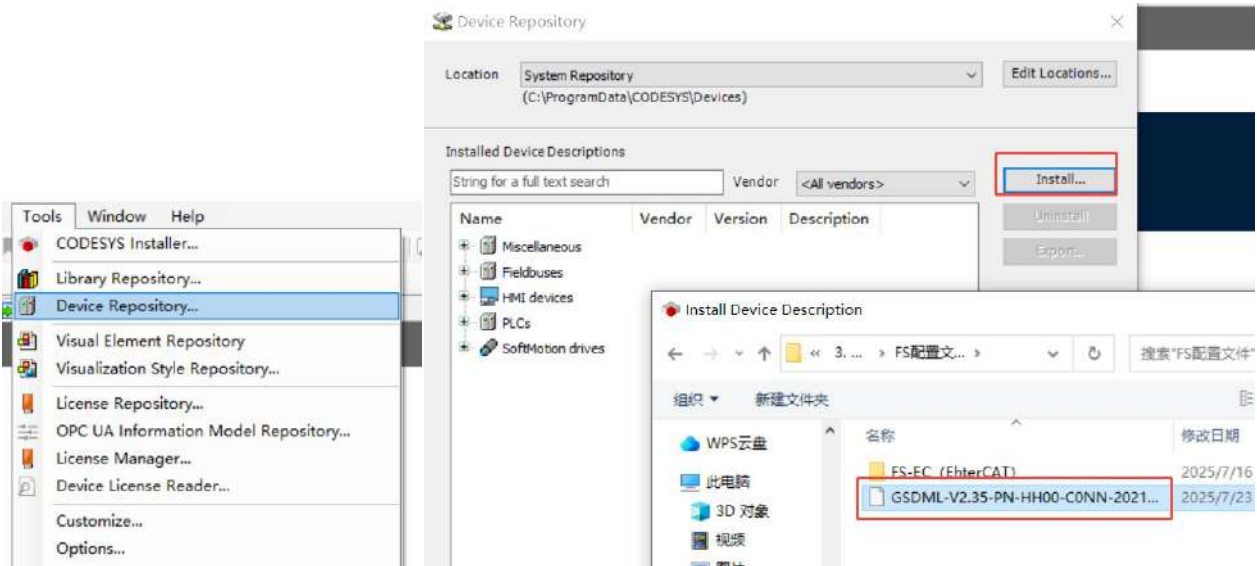

Figure 5-2-18Install GSD document

4, New Project and Equipment Configuration

Open CODESYS V3.5Software, select New Project > Project > Standard project”, as shown in the figure5-2-19shown.

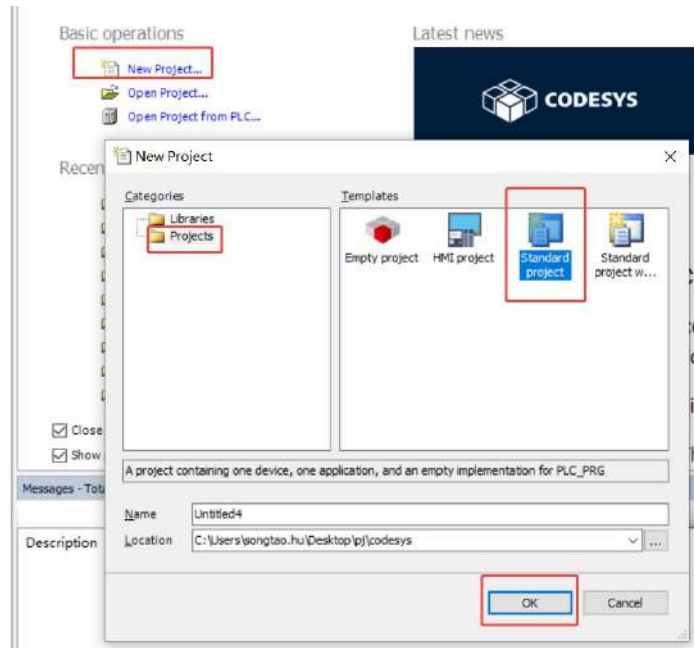

Figure 5-2-19 New Construction

In the standard project window, select "CODESYS SoftMotion Win V3" as the device, and choose "Structured Text (ST)" as the programming language for PLC_PRG, as shown in Figure 5-2-20.

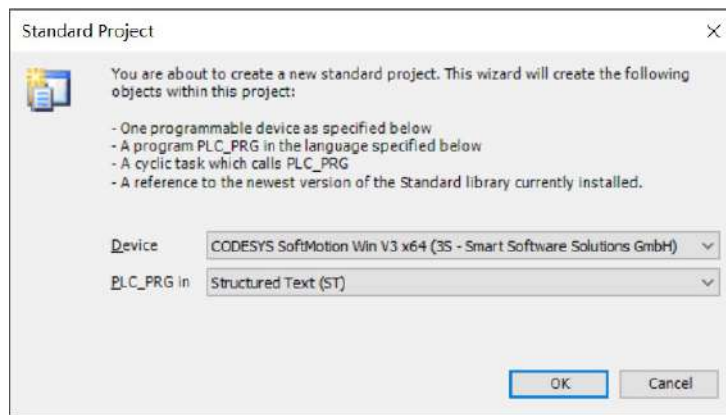

Figure 5-2-20 Select device and programming language

In the device tree, go to "Device (CODESYS SoftMotion Win V3)" > "Add Device", and add both the Ethernet adapter and the PROFINET IO Controller, as shown in Figures 5-2-21 and 5-2-22.

Tip: When configuring PROFINET IO in the native CODESYS software, if an error occurs due to a missing library, the user needs to manually double-click the Library Manager. In the Library Manager window, select and download the missing library—this process requires an active internet connection.

Additionally, pay attention to the IP address and subnet of the network port connected to the IO device. Make sure they are in the same subnet when setting the IP address of the IO device to avoid communication issues.

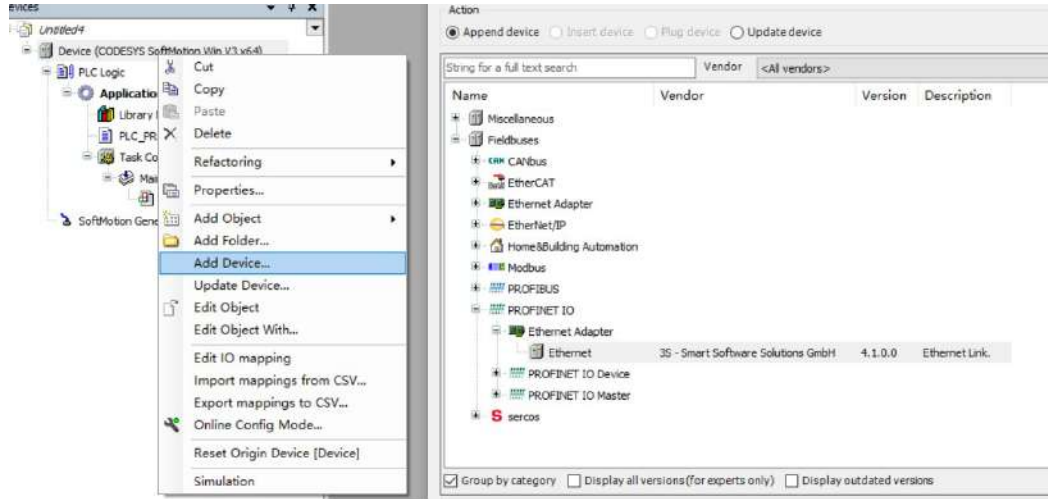

Figure 5-2-21 Adding an Ethernet Adapter

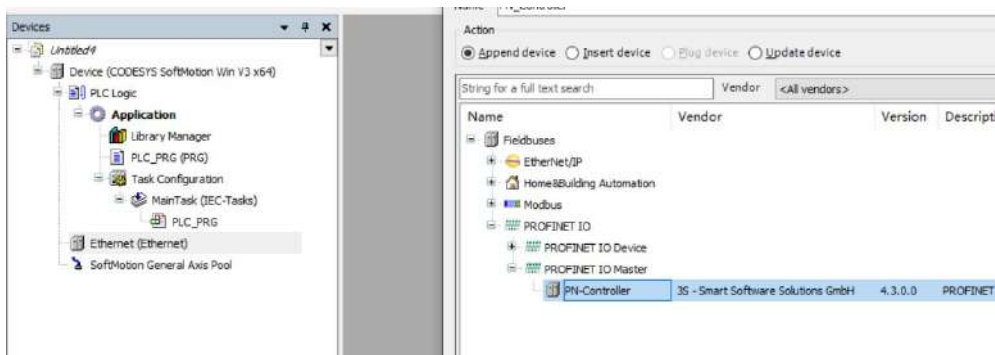

Figure 5-2-22 Add PROFINET IO Main Station

In the device tree, double-click "Ethernet" to assign the Ethernet port and configure the IP parameters of the PROFINET IO Controller, as shown in Figures 5-2-23 and 5-2-24.

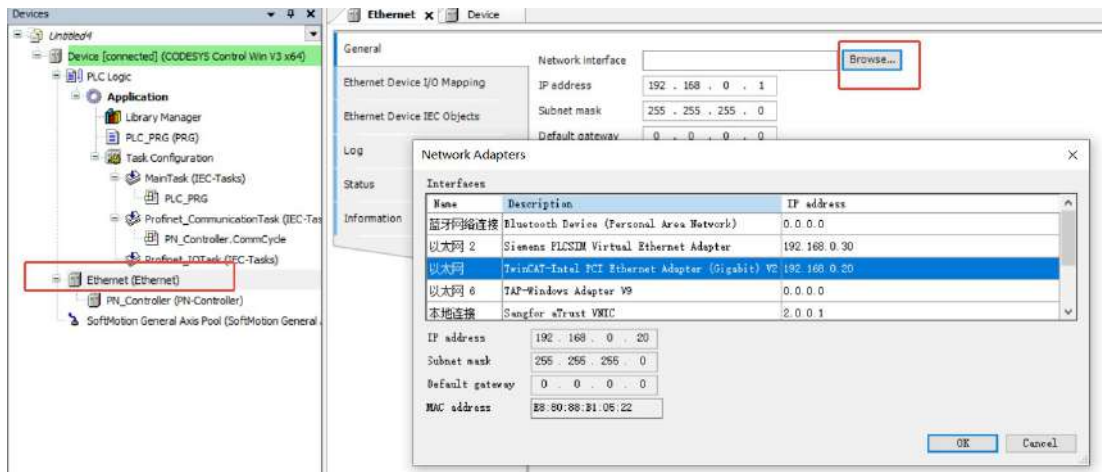

Figure 5-2-23 Ethernet allocation network port

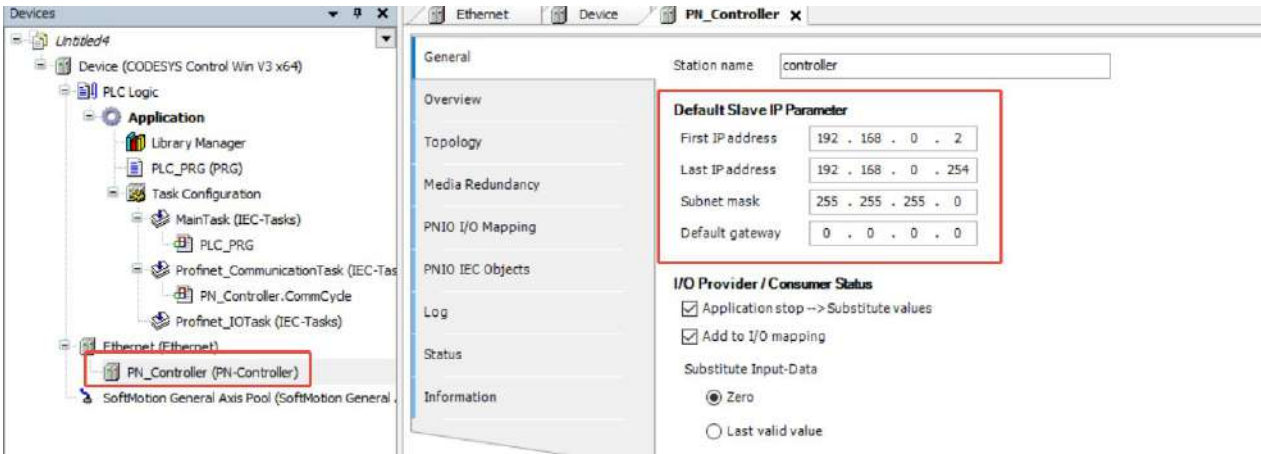

Figure 5-2-24 Setting PROFINET IO Master Station IP

Download the program to the controller and start it. Then exit login mode. Right-click PN_Controller and select "Scan Devices". In the device window, select the module and assign the device name and IP address, as shown in Figure 5-2-25. Then, copy the device into the project, as shown in Figure 5-2-26.

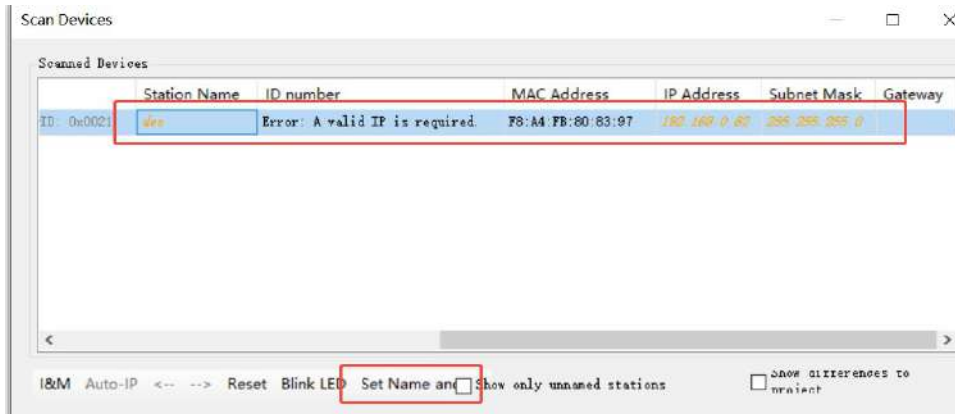

Figure 5-2-25 Assign a name to IP address

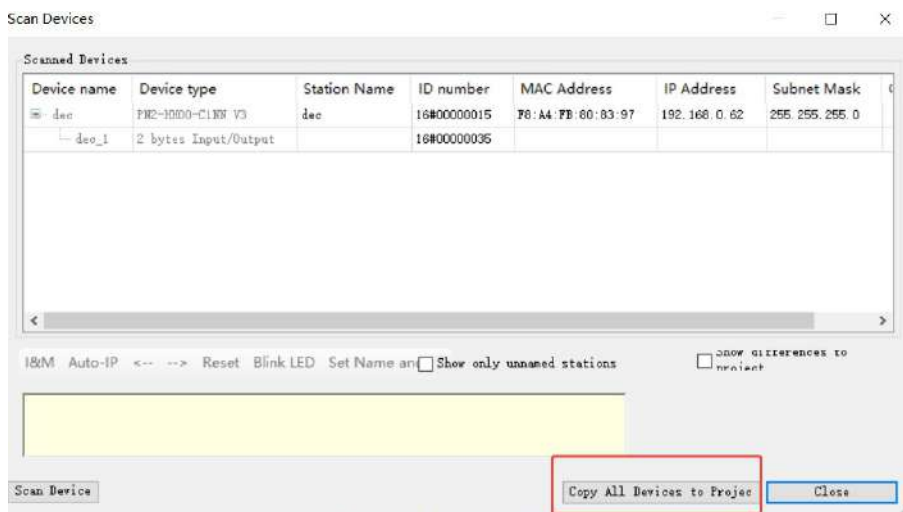

Figure 5-2-26 Copy the device to the project

5. Program download and device monitoring

Download the project to the controller and start running and monitoring, as shown in the figure5-2-27shown.

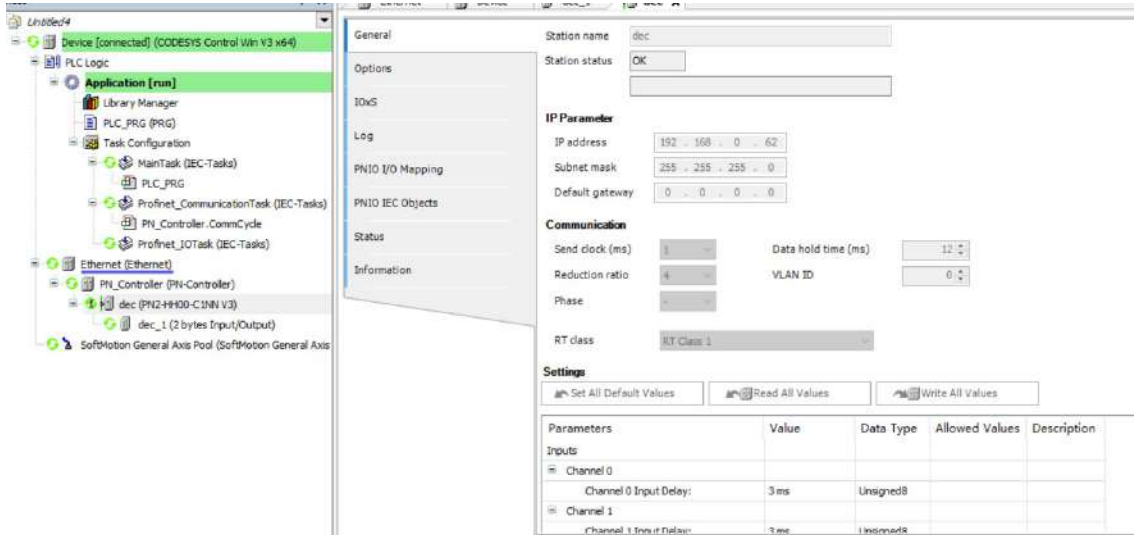

Figure 5-2-27 Program download and monitoring

5.3 CC-Link IE Field Basic protocol

5.3.1 GX-Works2 and CC-Link IE Field Basic protocol IO module connections and configuration

1. Communication connection diagram, as shown in the figure5-3-1shown.

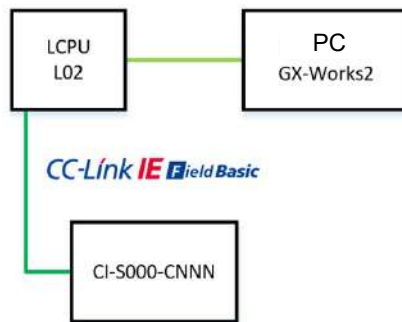

Figure 5-3-1 Communication connection diagram

2. Hardware configuration is shown in Table 5-3-1shown.

Table 5-5-1 Hardware Configuration Table

hardware	quantity	Remark
Programming Computer	1	Installing GX-Works2
Controller	1	L02
CI-HH00-C0NN	1	CC-Link IE Field Basic Protocol 16DI/16DO Module
Network cable	several	

3. Description file installation

Open the GX-Works2 programming software. From the menu bar, select “Tool” > “Profile” > “Login”, as shown in Figure 5-3-1, and then select the description file that needs to be installed.

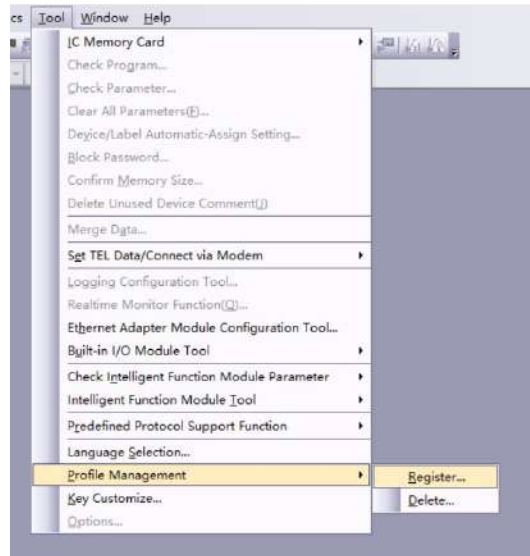

Figure 5-3-1 Description file installation

4. New construction projects

Open the GX-Works2 software. From the menu bar, select “Project” > “New”, then choose the PLC series, CPU type, and programming language. In this case, the L-series CPU is used as an example, as shown in Figure 5-3-2.

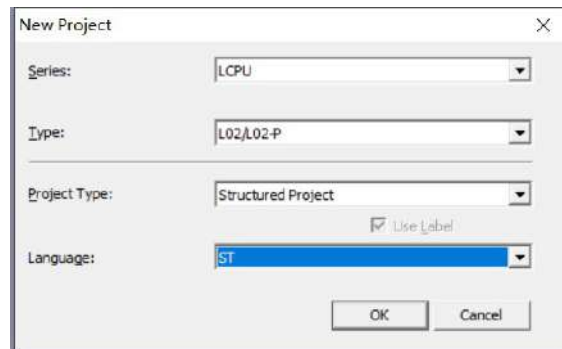

Figure 5-3-2 Select PLC type

To configure CC-Link IE Field Basic parameters, go to the left navigation window and select “Parameter” > “PLC Parameter”. In the L parameter settings window, choose “Built-in Ethernet Port Settings”, then set the IP address and subnet mask for the PLC master station. After completing the settings, click “CC-Link IE Field Basic Settings”, as shown in Figure

5-3-3.

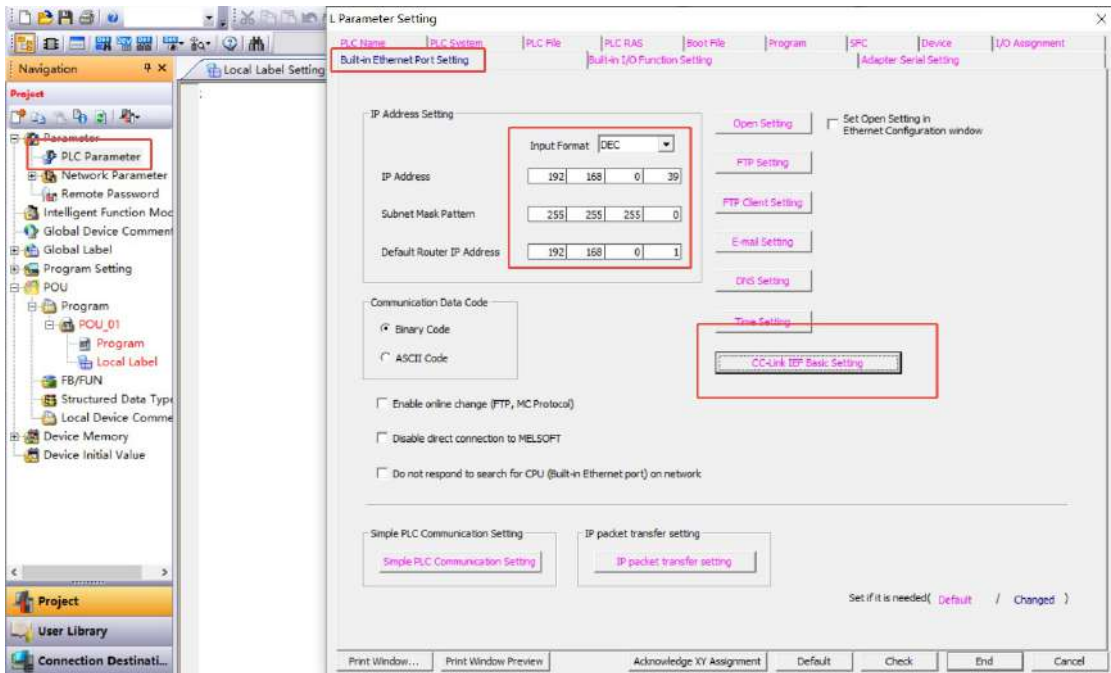

Figure 5-3-3 Setting PLC IP Address

In the CC-Link IE Field Basic settings window, check the option “Use CC-Link IE Field Basic”, and then click “Network Configuration Settings”, as shown in Figure 5-3-4.

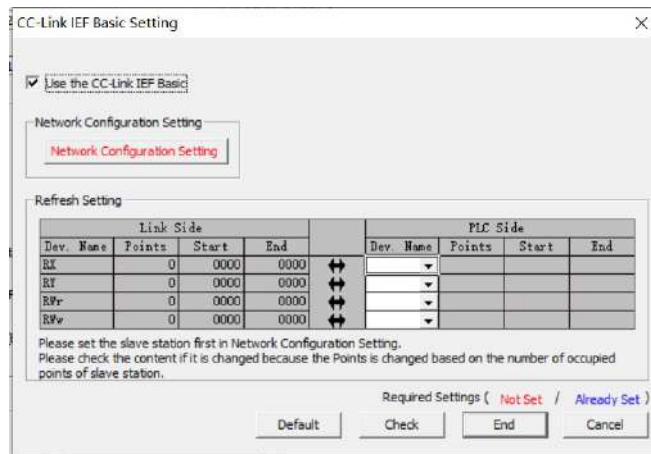

Figure 5-3-4 Network Configuration Settings

Method 1 for adding modules: Manual addition. In the CC-Link IE Field Basic configuration window, drag the I/O modules from the right side directly into the CPU area at the lower left for configuration, as shown in Figure 5-3-5.

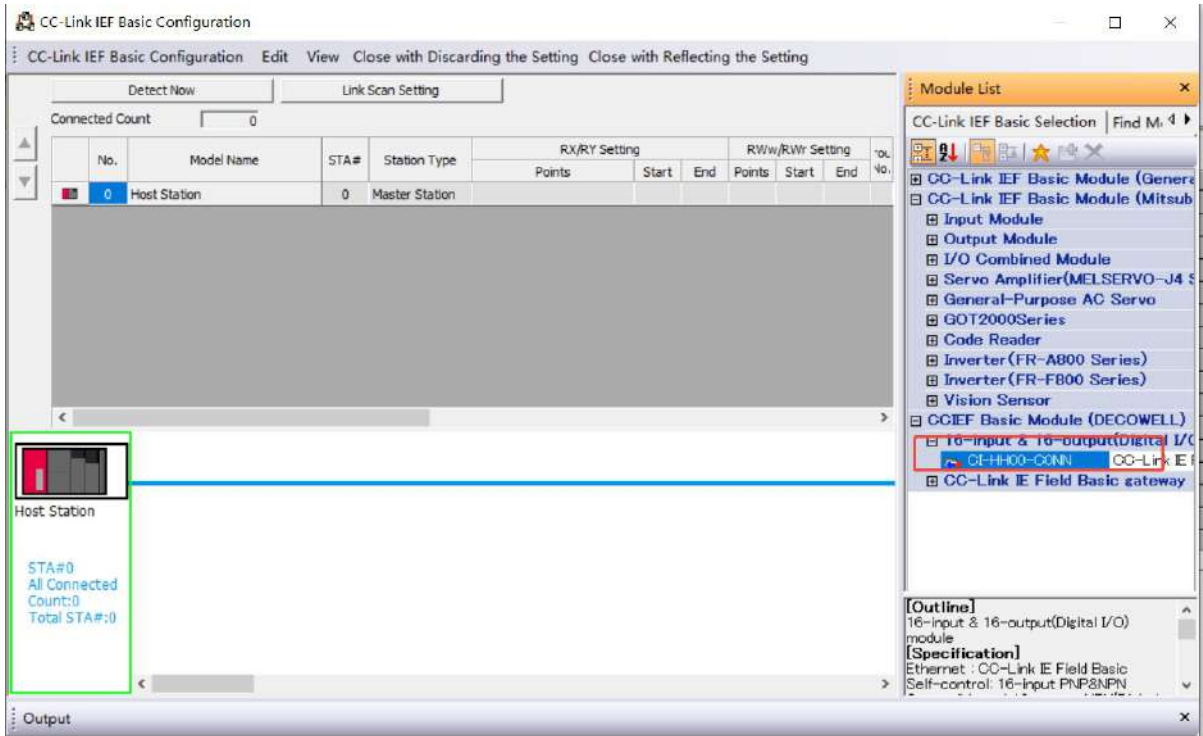

Figure 5-3-5 Manually add modules

Method 2 for adding modules: Scan modules on the network into the device configuration. In the CC-Link IE Field Basic configuration window, select “Auto-detect connected devices”, as shown in Figure 5-3-6.

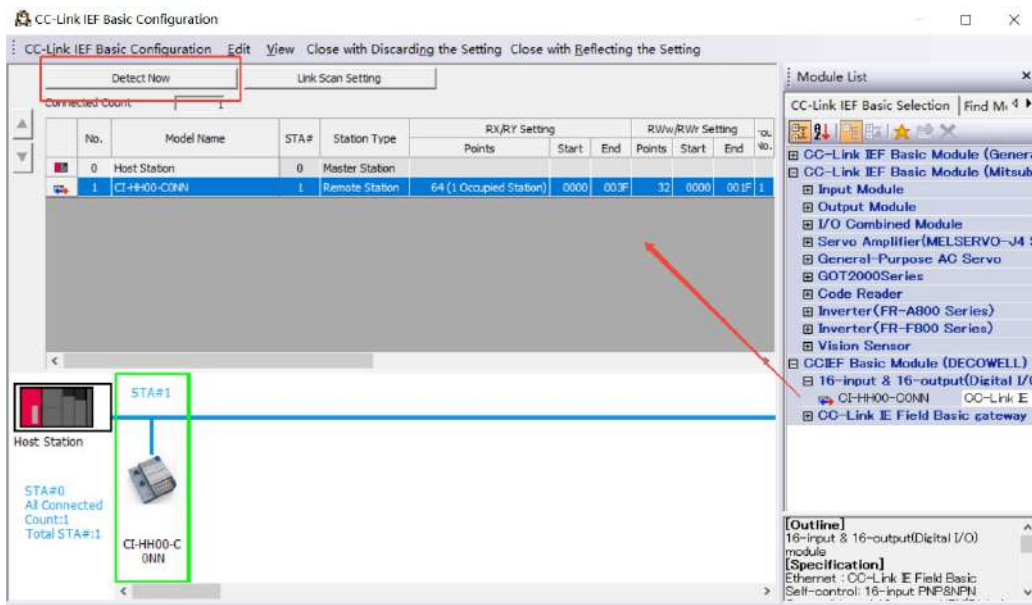

Figure 5-3-6 Scan the network for modules

To modify the module’s IP address (default IP address: 192.168.1.88), double-click the IP address field of the module in the CC-Link IE Field Basic configuration window to edit it. After modifying, right-click the module’s IP address, select “Online” > “Reflect Slave

Communication Settings” to apply the IP address change, as shown in Figure 5-3-7. Finally, click “Reflect Settings and Close”, as shown in Figure 5-3-8.

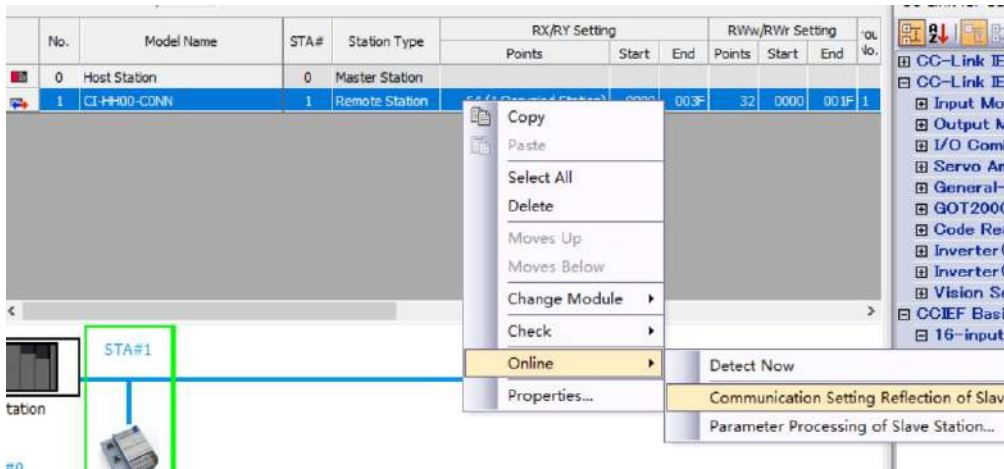

Figure 5-3-7 Modification Module IP address

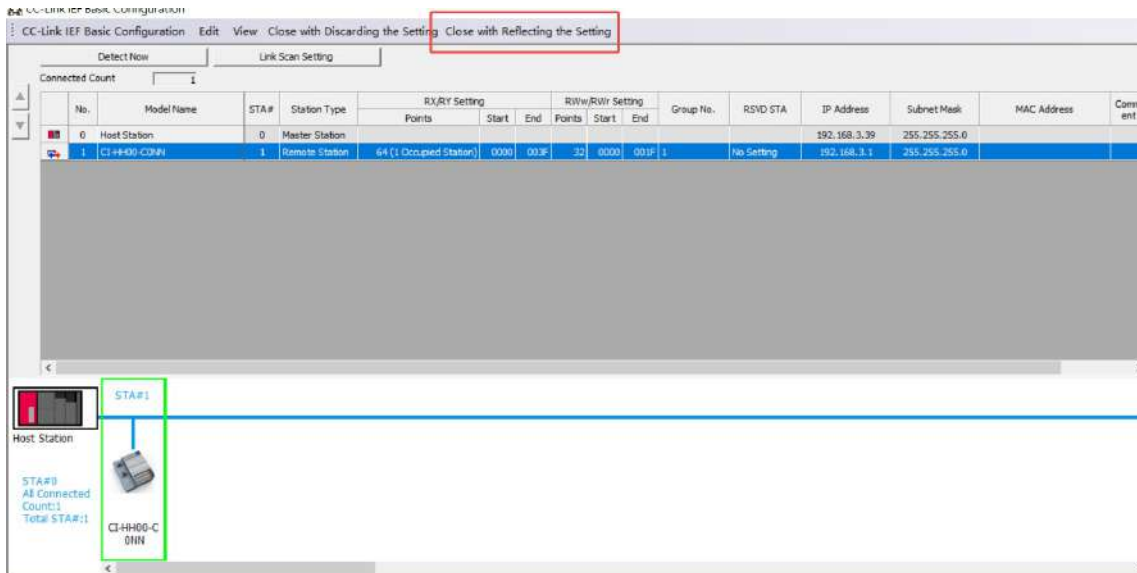

Figure 5-3-8 Reflect settings and close

I/O Mapping Configuration: In the CC-Link IE Field Basic configuration window, set the starting address points for the remote I/O module’s inputs and outputs, as shown in Figure 5-3-9.

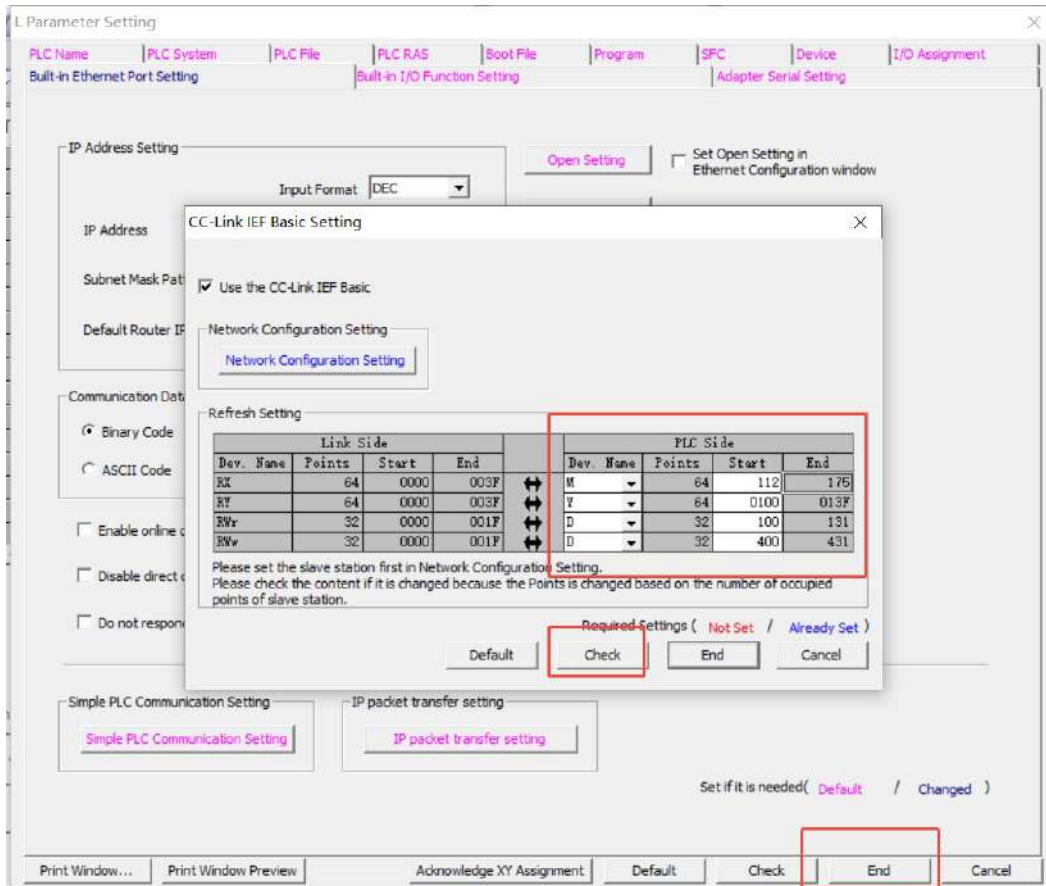

Figure 5-3-9 IO Mapping Configuration

5. CC-Link IE Field Basic Output Point Mapping Method: Each slave occupies 64 points, i.e., 64 DI and 64 DO. Here, the input and output points correspond to the starting addresses X100 and Y100, respectively. The slave I/O point mapping is shown in Figure 5-3-10.

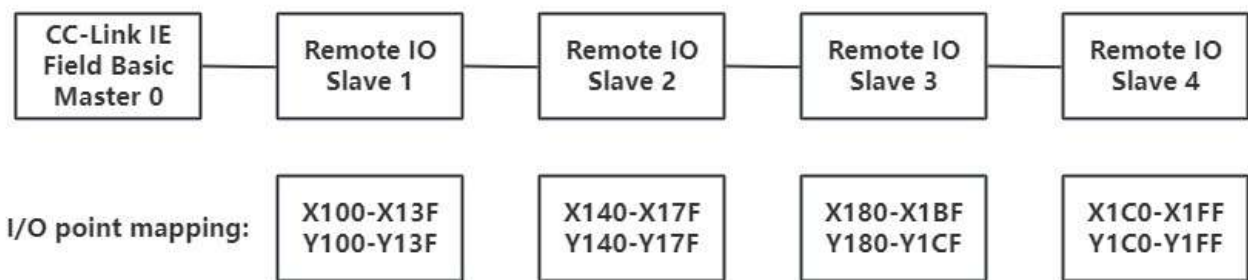

Figure 5-3-10 Slave IO Point Mapping

6. Diagnose communication status

After completing the parameter configuration, download the project to the PLC. You can then check the communication status through online diagnostics. From the menu bar, select "Diagnostics" > "CC-Link IE Field Basic Diagnostics", and view the status of the slave I/O

modules in the CC-Link IE Field Basic diagnostics window.

5.4 CC-Link protocol

5.4.1 GX-Works2 and CCLink protocol IO Module connections and configuration

1. Communication connection diagram, as shown in the figure5-4-1shown.

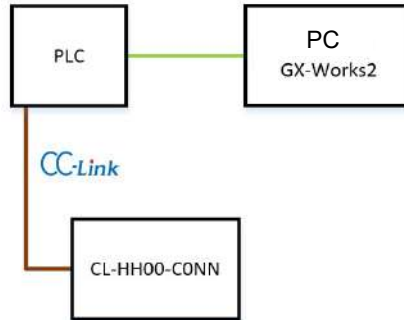

Figure 5-4-1Communication connection diagram

2. Hardware configuration as shown in the table5-4-1Shown

surface5-4-1Hardware Configuration Table

Hardware	Quantity	Remark
Programming Computer	1	InstallGX-Works2
PLC	1	Support CCLink protocol
CL-HH00-C0NN	1	CC-Linkprotocol 16DI/16DOModules
CCLink communication line	several	

3. New project and communication parameter configuration

Open the GX-Works2 software and select the actual CPU model used on site. Then, in the project’s left navigation pane, go to “Parameter” > “Network Parameter” > “CC-Link”. In the CC-Link parameter settings window, configure the CC-Link slave settings as shown in Figure 5-4-2, and the CC-Link network parameters as shown in Figure 5-4-3.

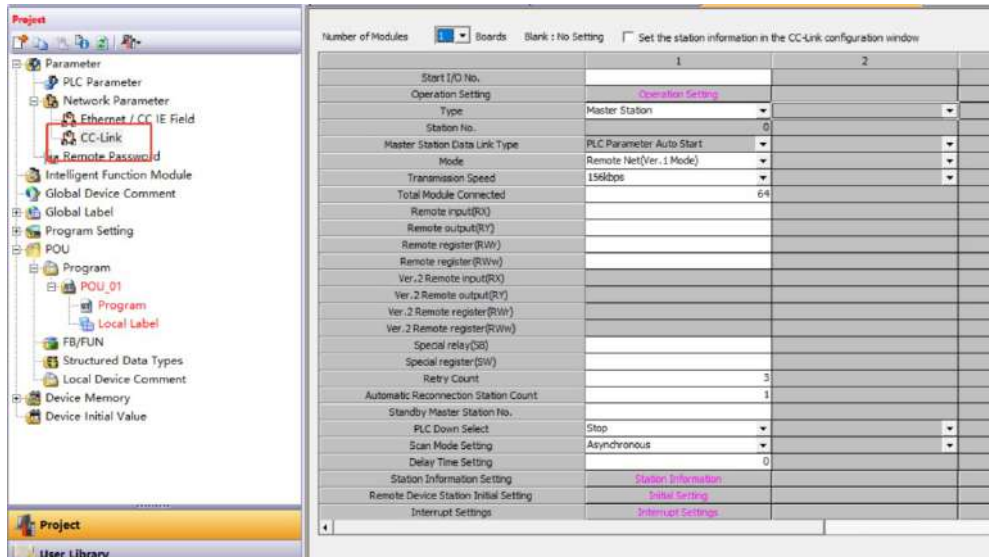

Figure 5-4-2 Open CCLink parameter setting window

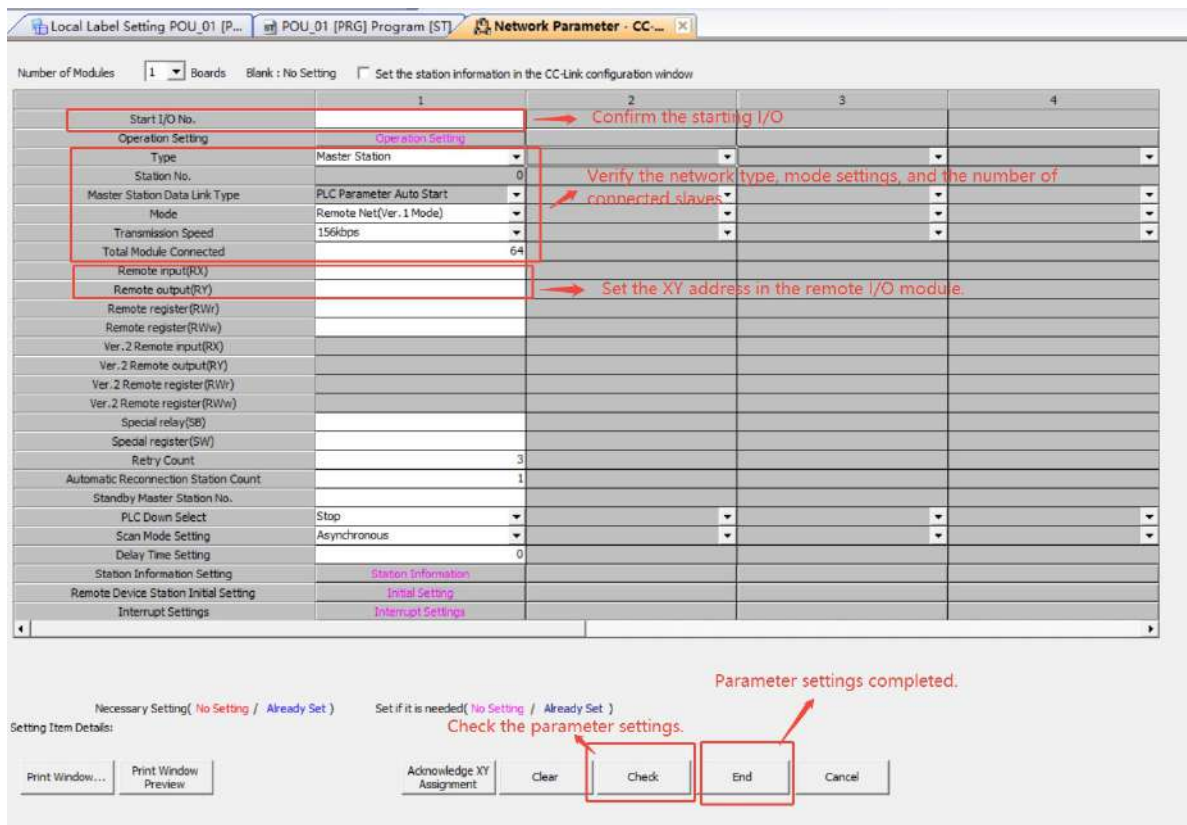

Figure 5-4-3 CC-Link parameter settings

4. CC-Link module communication address allocation diagram

FSSeries CCLink protocol remote IO Module as CCLink remote IO Station, each module occupies 32DI and 32DO (Mitsubishi CCLink protocol), module address allocation and use, as shown in Figure 5-4-4 shown.

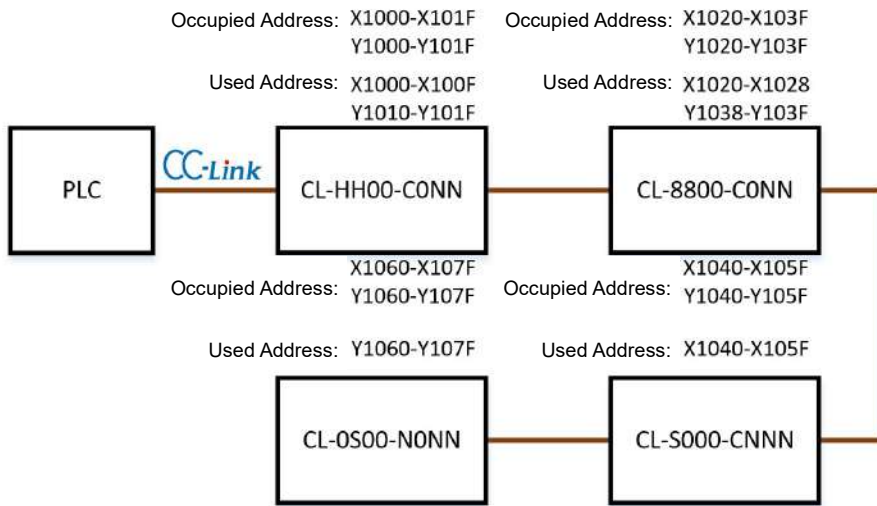

Figure 5-4-4 CC-Link address allocation

5.5 DeviceNet Protocol

5.5.1 CX-one and DeviceNet protocol IO Module connections and configuration

Tip: There are two configuration methods for communication between CX-One and EX-1010: manual and automatic. For details, please refer to items 4 and 5 in section 5.3.1.

1. Communication connection diagram, as shown in Figure 5-5-1 shown.

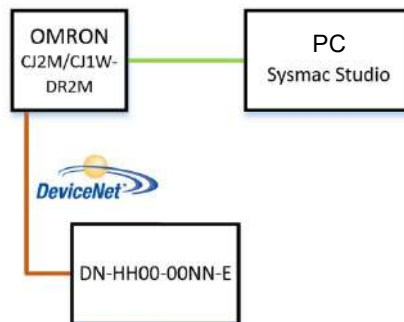

Figure 5-5-1 Communication connection diagram

Note: The power interface on the DeviceNet adapter requires a separate DC 24V power supply. Additionally, terminal resistors must be installed at both ends of the network. The wiring method for the terminal resistors is shown in Figure 5-5-2.

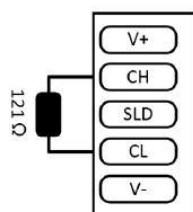

Figure 5-5-2 Terminal resistance wiring

2. Hardware configuration as shown in the table5-5-1Shown

surface5-5-1Hardware Configuration Table

Hardware	Quantity	Remark
Programming Computer	1	CX-one
Controller	1	CJ2M/CJ1W-DR2M
DN-HH00-C0NN	1	DeviceNet protocol 16DI/16DOmodules
DeviceNet communication line	several	

3、Install EDS document

Open the CX-Integrator configuration software, select "Tools" > "DeviceNet Tools" > "Edit Configuration File" > "Vendor ID/Equipment Type Table", as shown in the figure5-5-3shown.

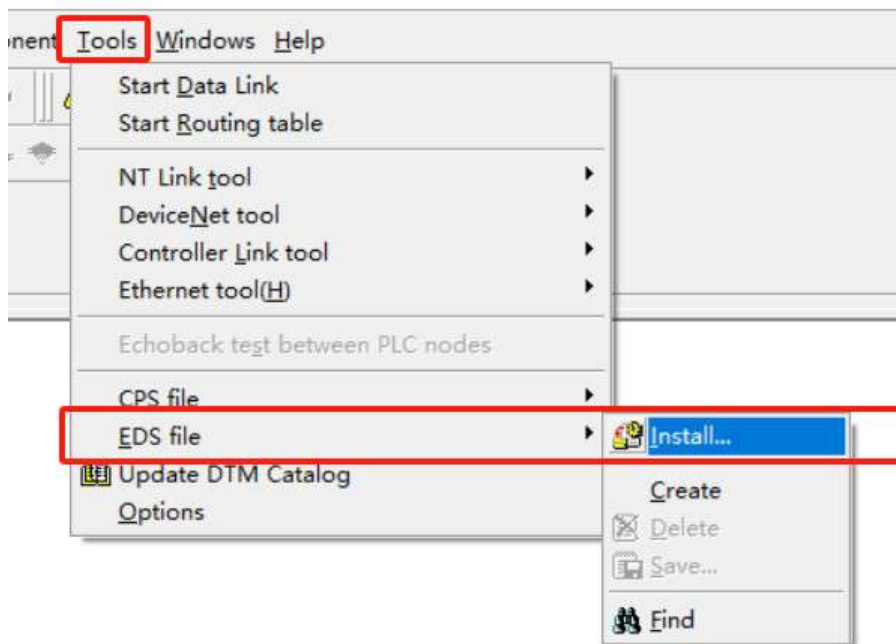

Figure 5-5-3Install EDSdocument

4, Device Configuration (Auto Scan)

Open the CX-Integrator configuration software, in the menu bar select 'Network' > 'Communication Settings', and choose the PLC model as 'CJ2M (CPU Model: CPU31)', as shown in Figure 5-5-4.

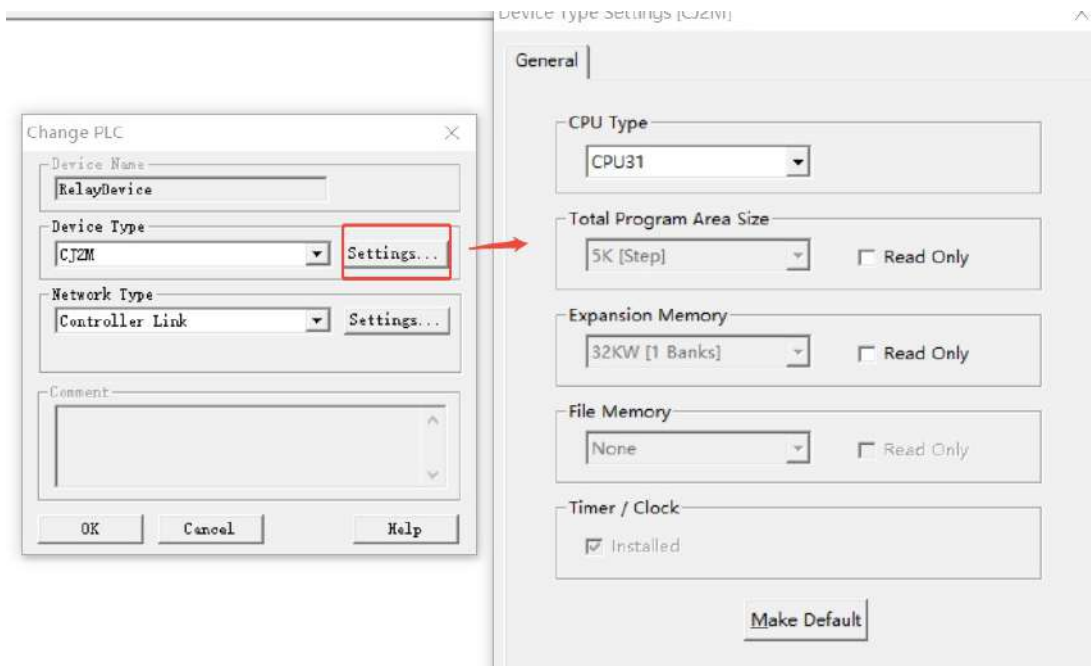

Figure 5-5-4 Configuration CPU

Automatic scanning, click the 'Online Work' button, double-click the DeviceNet [CJ1W-DRM21] network (-), node (1), unit (0), and set the network name, then confirm the transfer as shown in Figure 5-5-5. Double-click DN-HH00-C0NN to check if the Omron PLC can detect the DN-HH00-C0NN slave station.

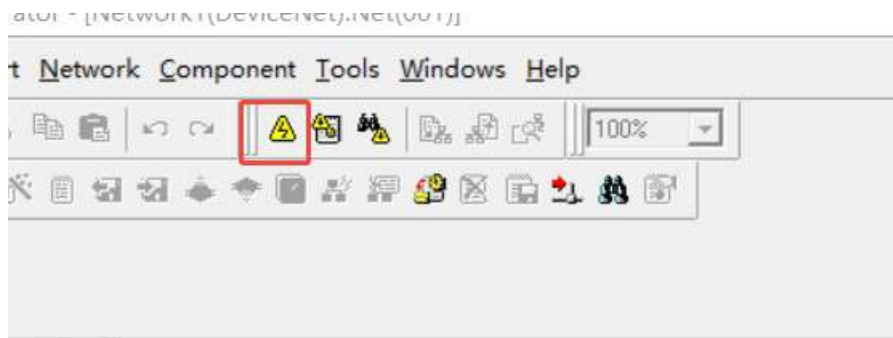

Figure 5-5-5 Automatic scanning

5. Device Configuration (Manual Configuration)

On the right side, click "New Project", select "Insert Network", and select "DeviceNet" as shown in the figure 5-5-6 shown.

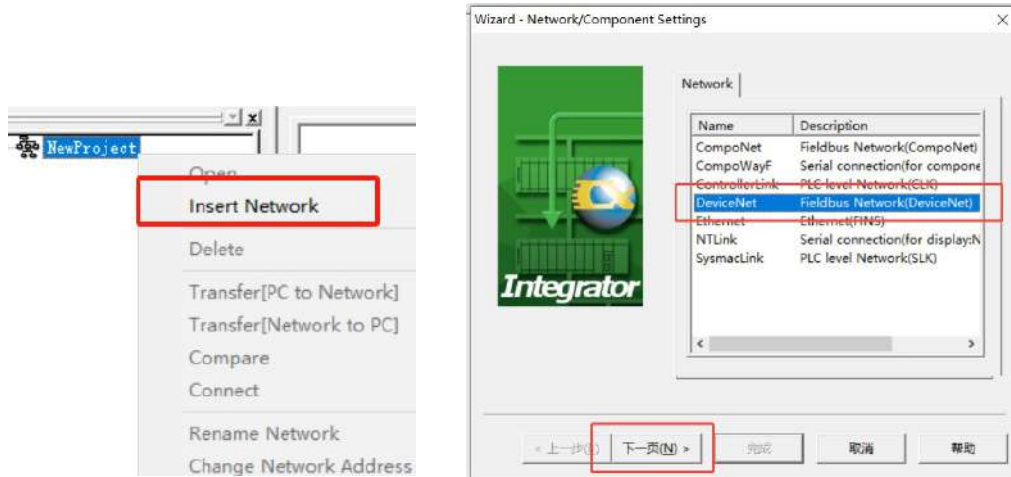

Figure 5-5-6 Insert Network

In the inserted network, add Devise firstNet Communication Module CJ1W-DRM21, then add IODevice, right-click the network icon > "Insert Component", select DN-HH00-C0NN, as shown in the figure5-5-7shown.

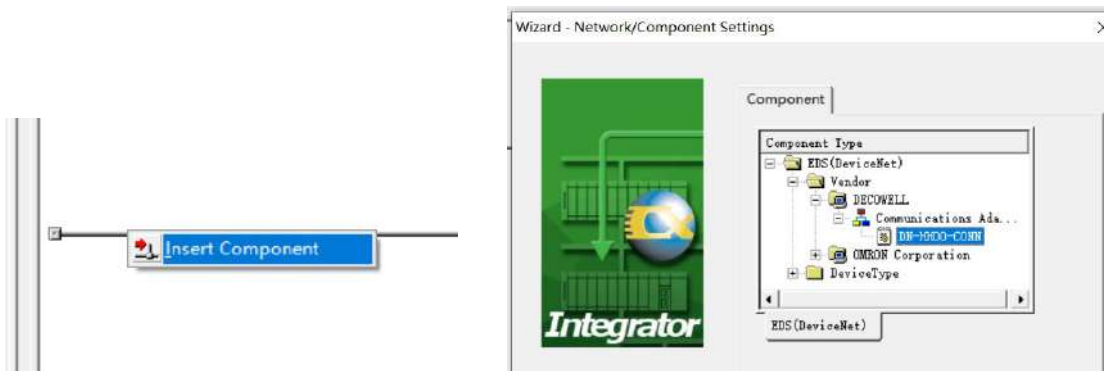

Figure 5-5-7 Add Remote IO Modules

6, download configuration information

Right-click "CJ1W-DR2M" icon, select "Parameters" > "Edit", as shown in the figure5-5-8shown.

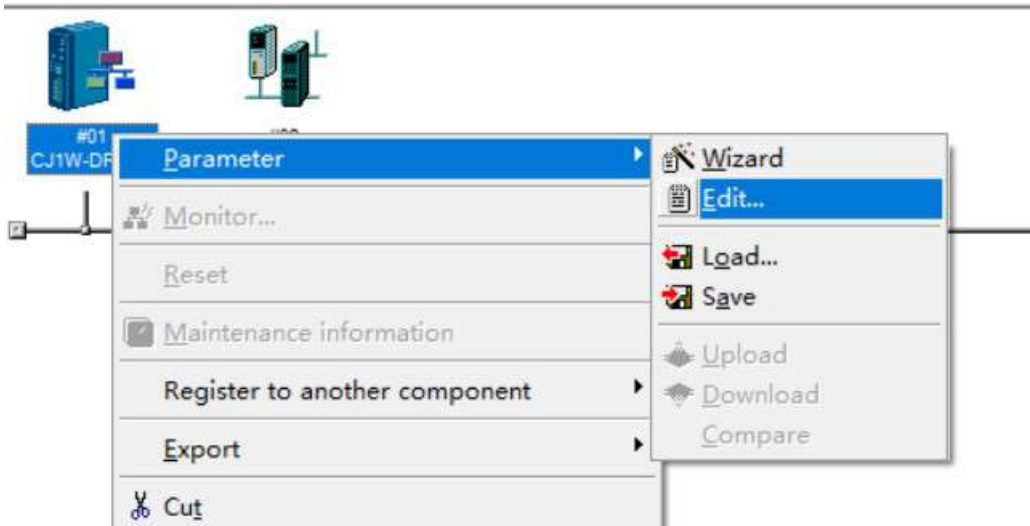

Figure 5-5-8Open parameter editing

In the Edit Device Parameters window, select the "Register button" to register the slave device, as shown in the figure5-5-9After successful registration, you can see the PLC internal address corresponding to the input and output of the slave I/O module. Finally, click the "Download" button to download the configuration information to the PLC, as shown in the figure5-5-10After the download is complete, you can see that the NET RUN indicator on the adapter is on and the SYS indicator flashes once per second.

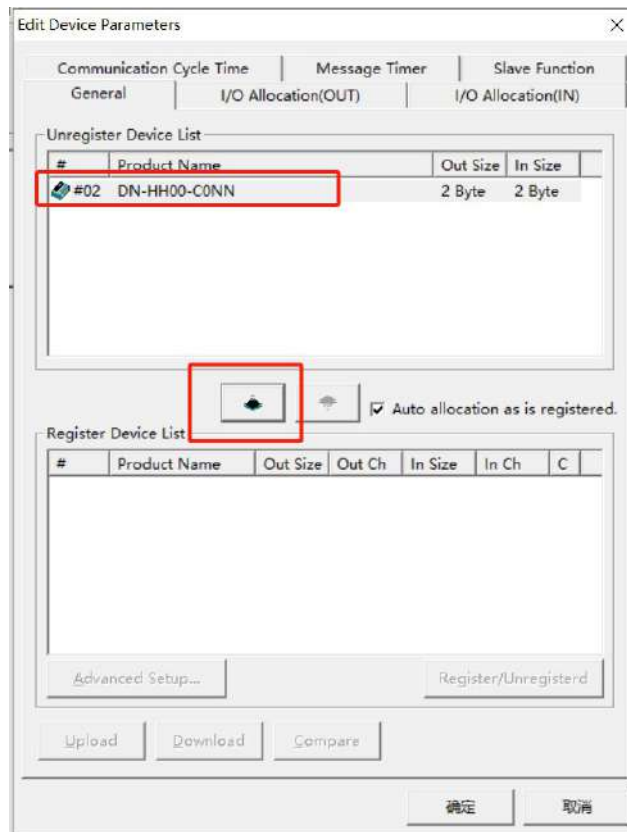

Figure 5-5-9Slave Device Registration

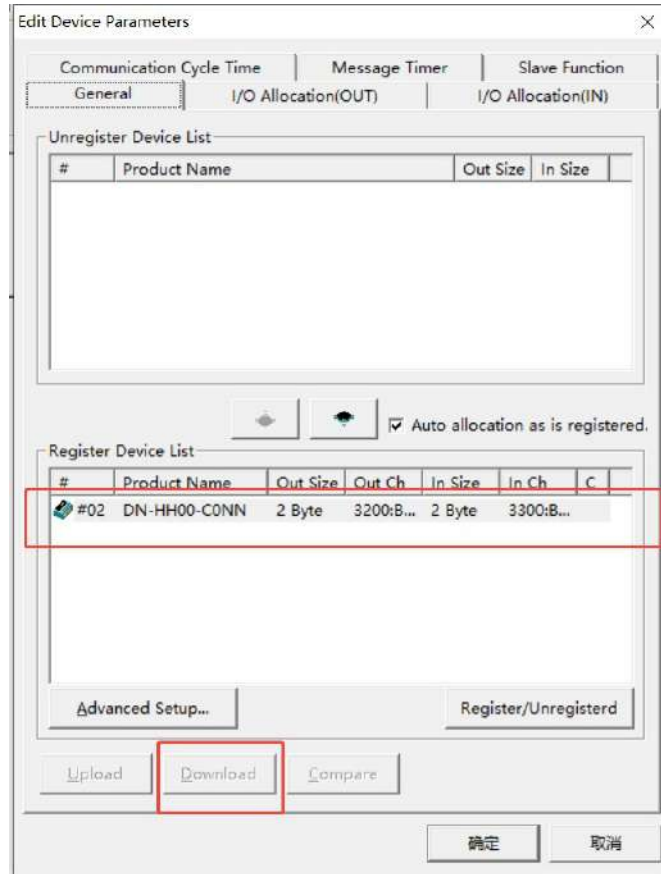

Figure 5-5-10Download Configuration

5.6 CAN open protocol

5.6.1 AutoShop with CANopen Protocol IO Modules

1. Communication connection diagram, as shown in Figure 5-6-1 shown.

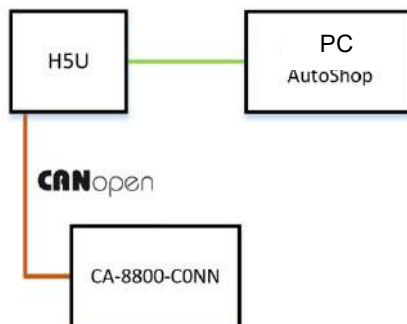

Figure 5-6-1 Communication connection diagram

Notice:The power interface on the CANopen adapter requires a separate DC 24V power supply. Terminal resistors must be added to both end modules of the network. The wiring method for the terminal resistors is shown in Figure 5-6-2.

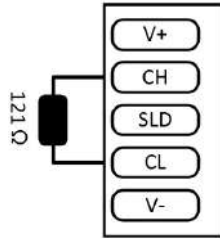

Figure 5-6-2 Terminal resistance wiring

2. Hardware configuration is shown in Table 5-6-1 Shown

Table 5-6-1 Hardware Configuration Table

Hardware	Quantity	Remark
Programming Computer	1	AutShop
Controller	1	H5U-A8
CA-8800-C0NN	1	CANopen 8DI/8DO Modules
Communication line	several	

3. Create a project

Open the AutoShop software, select the actual model corresponding to H5U and create a project. In the configuration panel on the left side of the project, double-click “CAN (CANLink)”, change the protocol type to CANopen, and set the communication baud rate to 125 kbps, as shown in Figure 5-6-3.

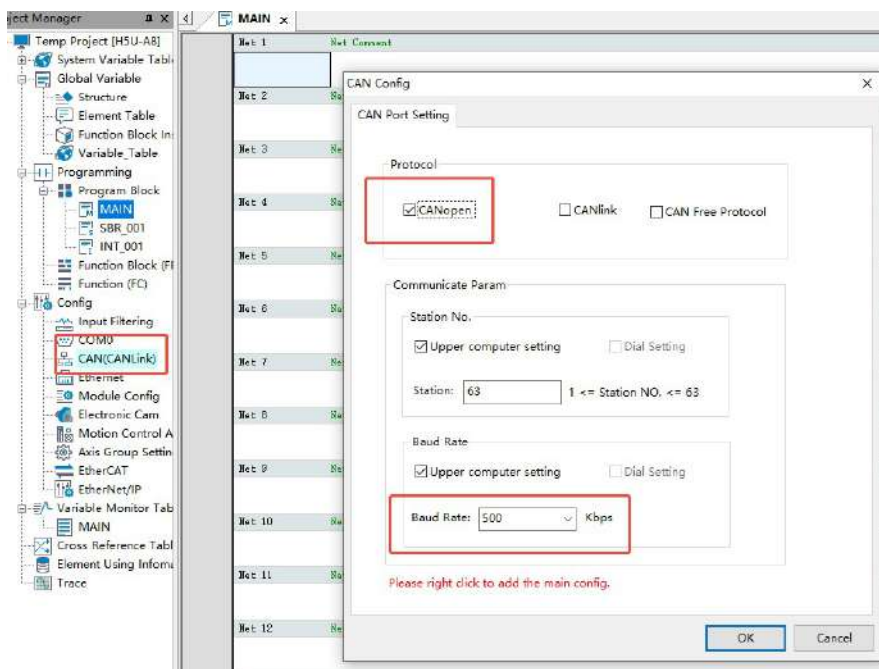

Figure 5-6-3 CANOpen communication parameter settings

Install EDS document

In the configuration panel on the left, right-click “CAN (CANopen)” and select “Add CAN Configuration.” Then double-click the CANopen configuration. In the blank area of the CANopen device list on the right side of the view, right-click and select “Import EDS,” as shown in Figure 5-6-4.

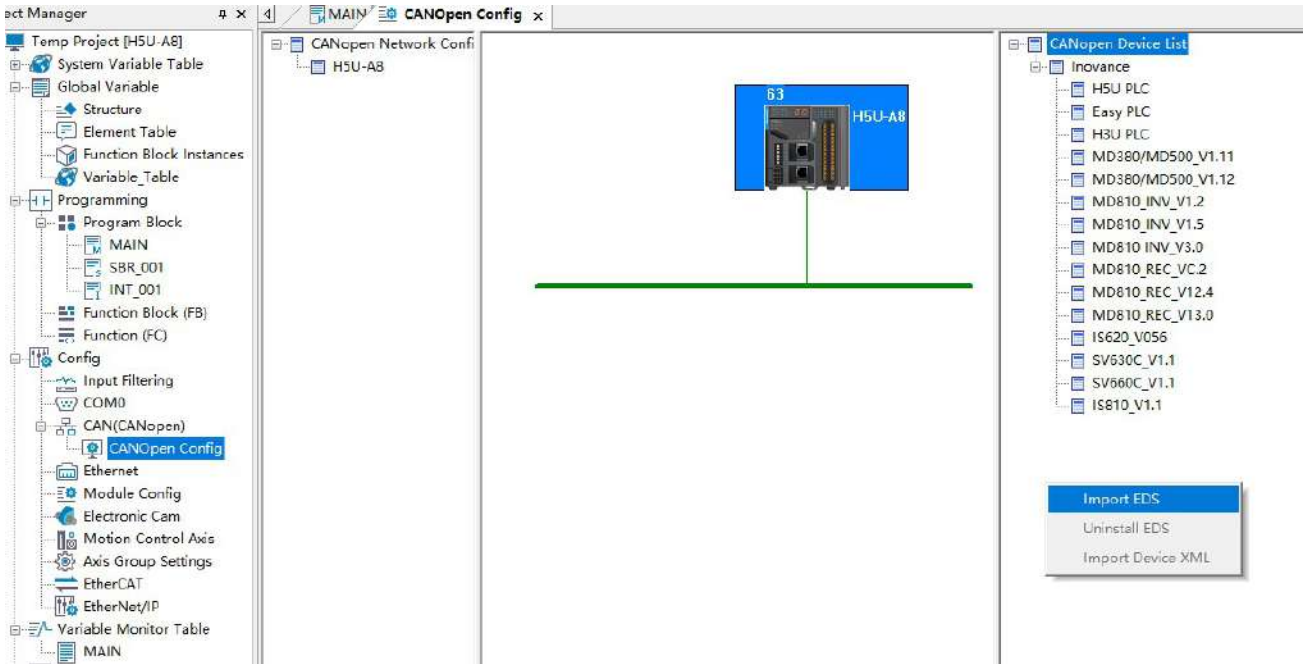

Figure 5-6-4 Install EDS document

Right click "CAN (CANLink)" and select "Add CAN Config", and add CA-8800-C0NN module, as shown in Figure 5-6-5As shown;

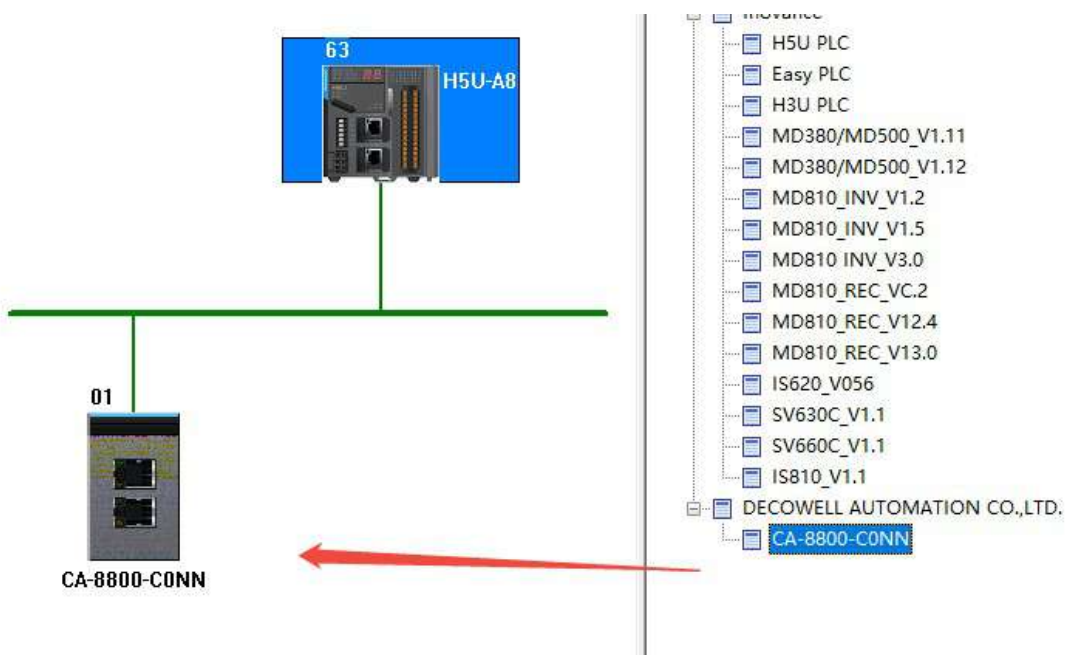

Figure 5-6-5 Add CANopen module

Double-click the CA-8800-C0NN module in the configuration panel, and configure the Node ID (Note: The Node ID must match the actual address set by the DIP switch; otherwise, communication will not function properly), as shown in Figure 5-6-7. Then check the I/O mapping addresses of the actual CANopen module, as shown in Figure 5-6-8.

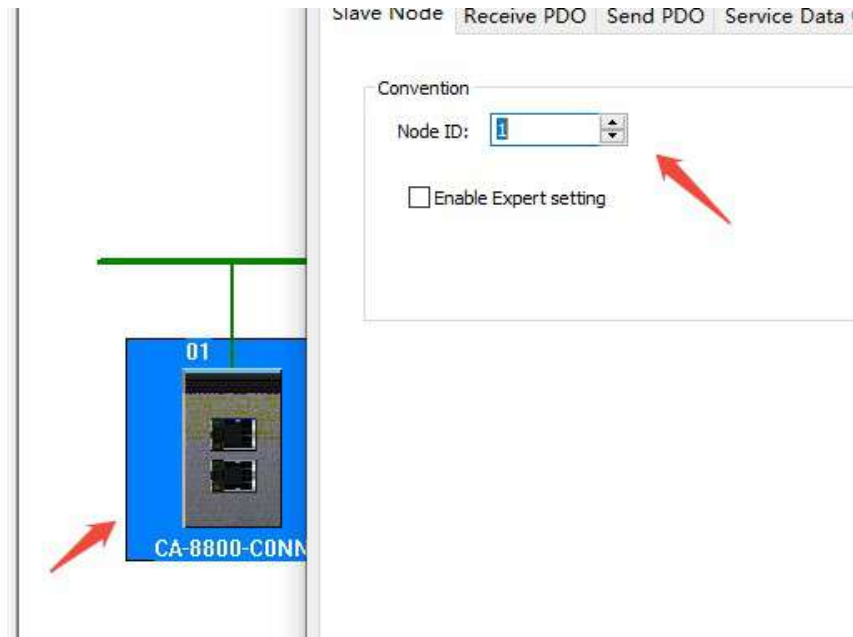

Figure 5-6-7 Setting Node ID

CA-8800-C0NN

Slave Node Receive PDO Send PDO Service Data Objects Debug I/O Mapping Module information

Variable	Mapping	Index: Subindex	Bit Length
-- D7000	Receive PDO 1 Mapping	16#1600	8
D7000_L	Write Outputs 0x1 to 0x8	16#6200:1	8
-- D7400	Transmit PDO 1 Mapping	16#1A00	8
D7400_L	Read Inputs 0x1 to 0x8	16#6000:1	8

Figure 5-6-8 I/O Address Mapping

Tip: In this example, D700_L stores the values of the 8-channel digital outputs, while D7400_L stores the values of the 8-channel digital inputs.

5.6.2 InoProShop with CANopen Protocol IO Modules

1. Communication connection diagram, as shown in Figure 5-6-9 shown.

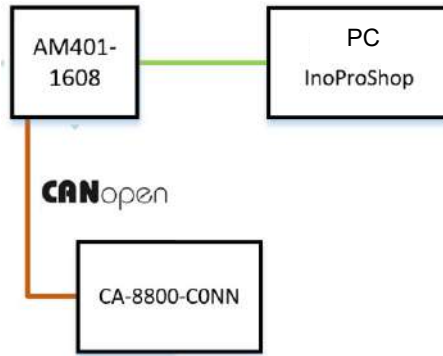

Figure 5-6-9 Communication connection diagram

Notice:The power interface on the CANopen adapter requires a separate DC 24V power supply. Terminal resistors must be added to both end modules of the network. The wiring method for the terminal resistors is shown in Figure 5-6-10.

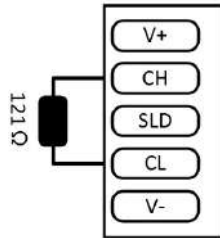

Figure 5-6-10 Terminal resistance wiring

2. Hardware configuration is shown in Table 5-6-2 Shown

Table 5-6-2 Hardware Configuration Table

Hardware	Quantity	Remark
Programming Computer	1	InoProShop
Controller	1	AM401-1608
CA-8800-C0NN	1	CANopen 8DI/8DO Modules
Communication line	several	

3. Install EDS document

Open InoProShop Programming software, select "Tools" > "Device Library" in the menu bar, select "Install" in the device library window, and select the EDS File, as shown in Figure 5-6-11 shown.

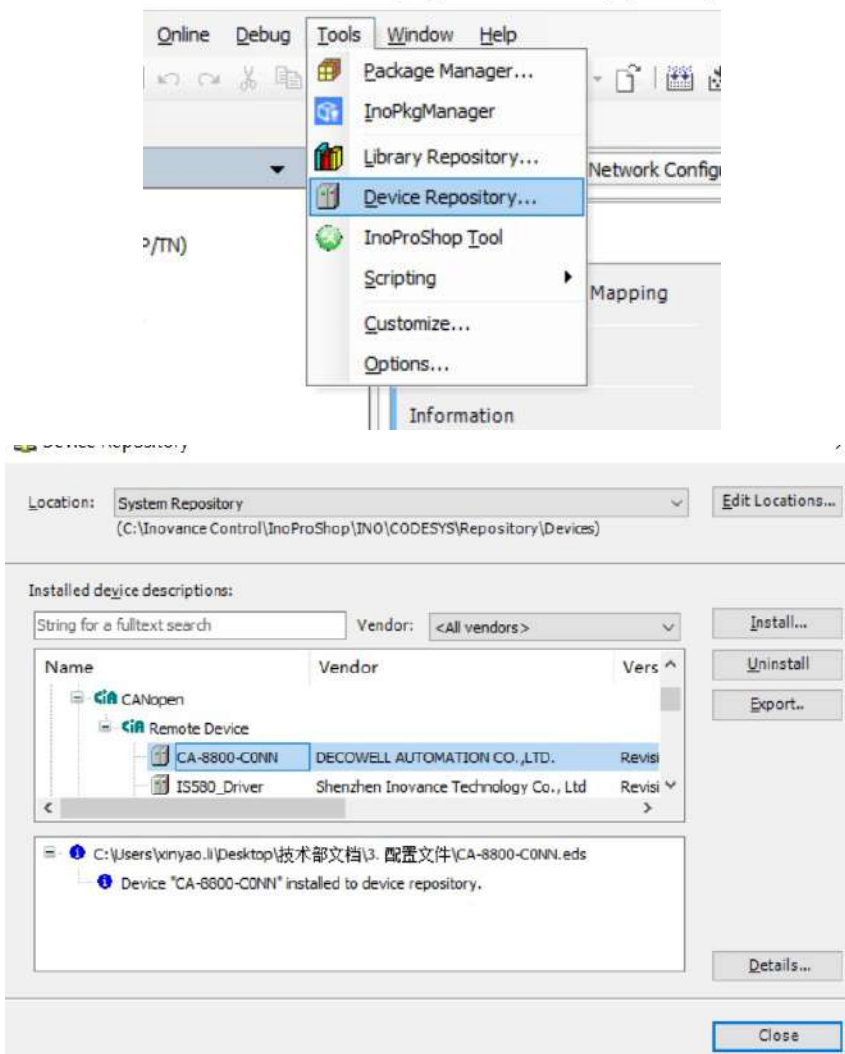

Figure 5-6-11 Install EDSdocument

4. Create a project

Open the InoProShop programming software, create a new project, and select the actual corresponding CPU model. In the project configuration panel on the left, double-click to open “LocalBus Config,” then click on the CPU and select “CANOpen Master,” as shown in Figure 5-6-12.

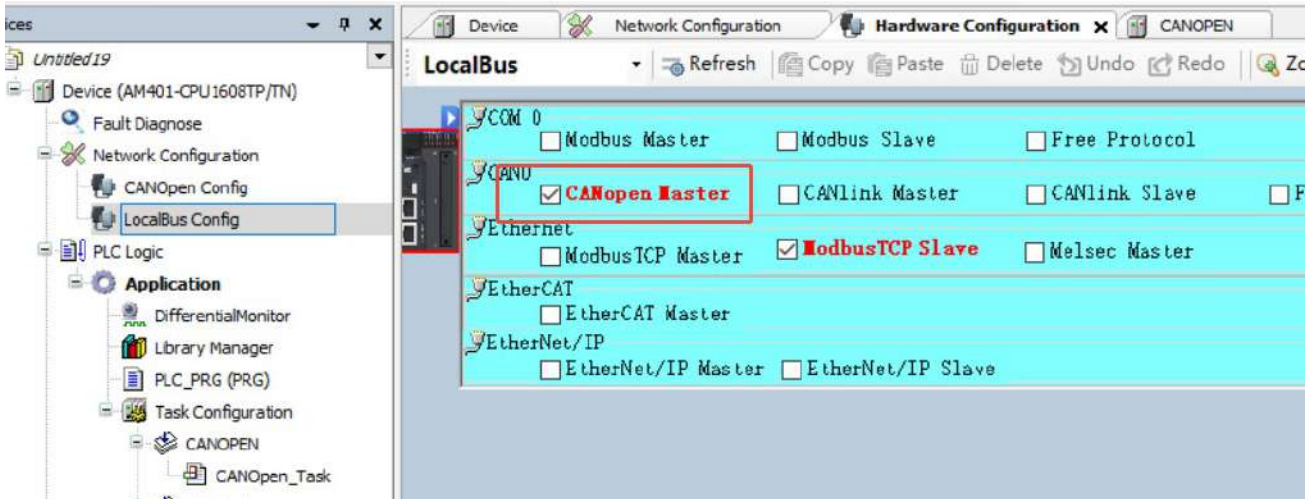

Figure 5-6-12 Configuration CANopen

In the device list on the left, double-click “CANOPEN (CANopen Master)” to configure the communication parameters of the CANopen master, as shown in Figure 5-6-13.

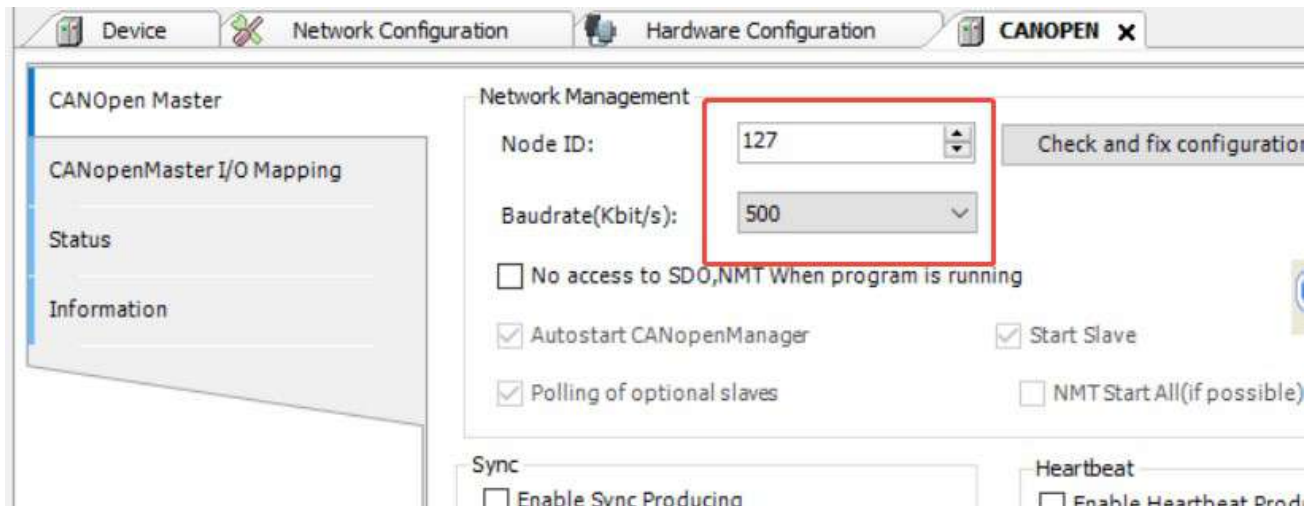

Figure 5-6-13 Configuration CANopen master station communication parameters

Double-click to open “Network Configuration.” In the configuration window, drag and drop “CA-8800-C0NN” from the third-party manufacturer list under the CANopen device list into the network device list, as shown in Figure 5-6-14.

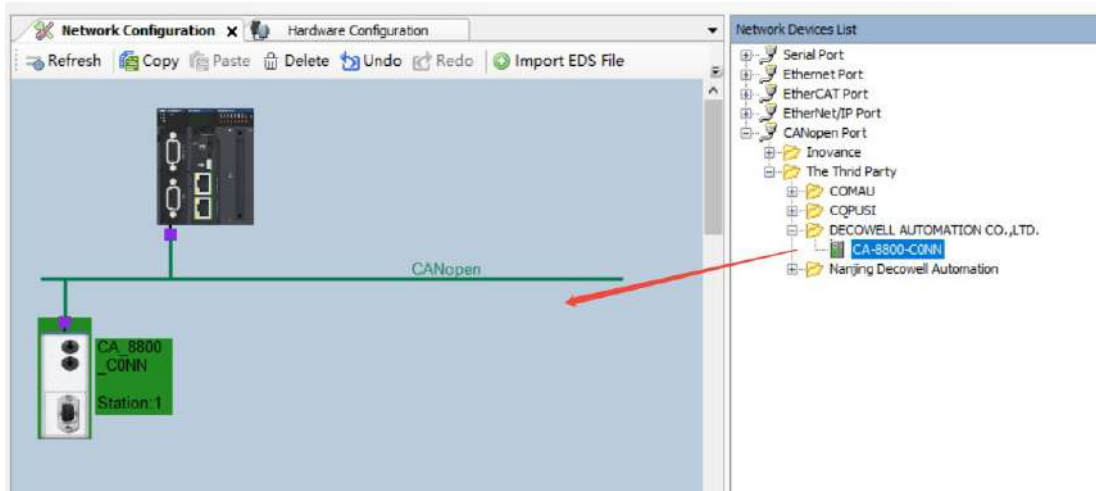

Figure 5-6-14 Add CANopen module

In the device list, double-click the CA-8800-C0NN module and configure the Node ID (Note: The Node ID must match the address set by the physical DIP switch; otherwise, communication will not function properly), as shown in Figure 5-6-15. Then check the I/O mapping addresses of the actual CANopen module, as shown in Figure 5-6-16.

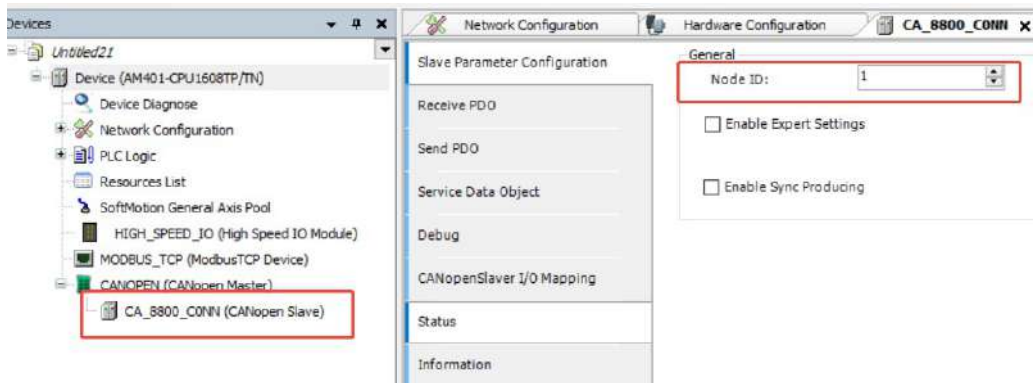

Figure 5-6-15 Setting Node ID

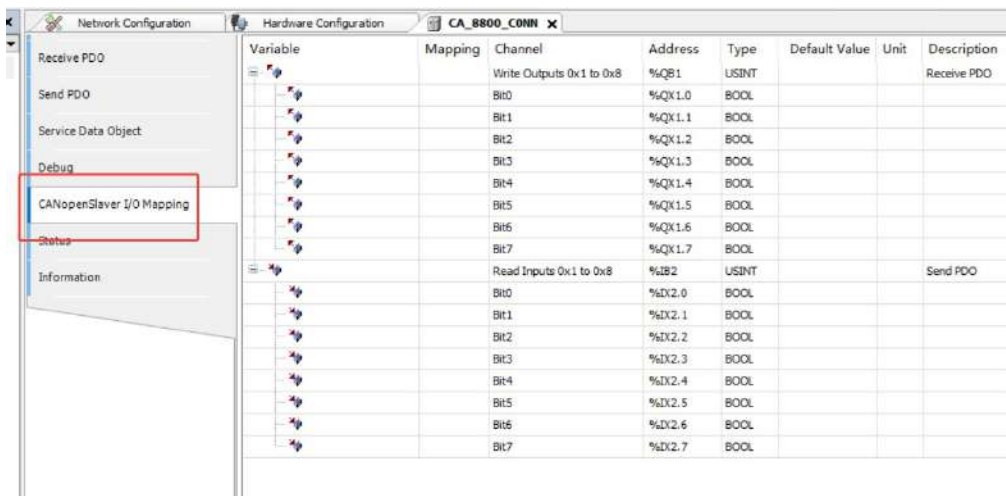

Figure 5-6-16 I/O Address Mapping

5.7 EtherNet/IP Protocol

5.7.1 KV STUDIO With EtherNet/IP protocol IOModule connections and configuration

1. Communication connection diagram, as shown in Figure 5-7-1Shown

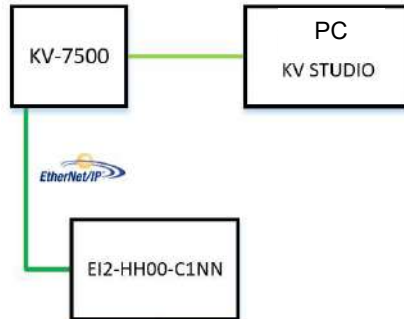

Figure 5-7-1Communication connection diagram

2. Hardware configuration as shown in Table 5-7-1Shown

Table 5-7-1Hardware Configuration Table

hardware	quantity	Remark
Programming Computer	1	KV STUDIO,IP Setting Tool software
PLC	1	KV-7500
EI2-HH00-C1NN	1	EtherNet/IP Protocol 16DI/16DOModules
Communication line	several	

Module IP Address Settings

Open IP Setting Tool software, select the network card connected to the module, and scan the online IO Module, as shown in Figure 5-7-2shown.

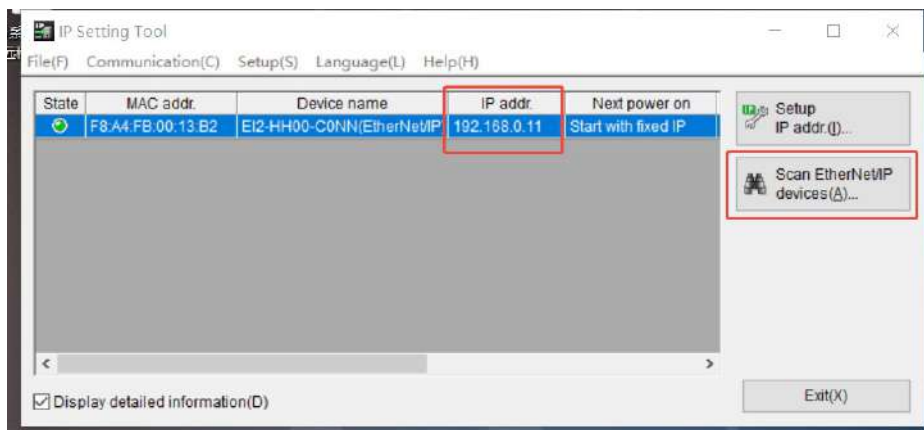

Figure 5-7-2Scan Online IOModules

Select the module in the scan list whose IP address needs to be modified (Note: the module is set to BOOTP by default at the factory and has no IP address. After setting the IP address, be sure to select "Static IP" as the startup mode), as shown in Figure 5-7-3.

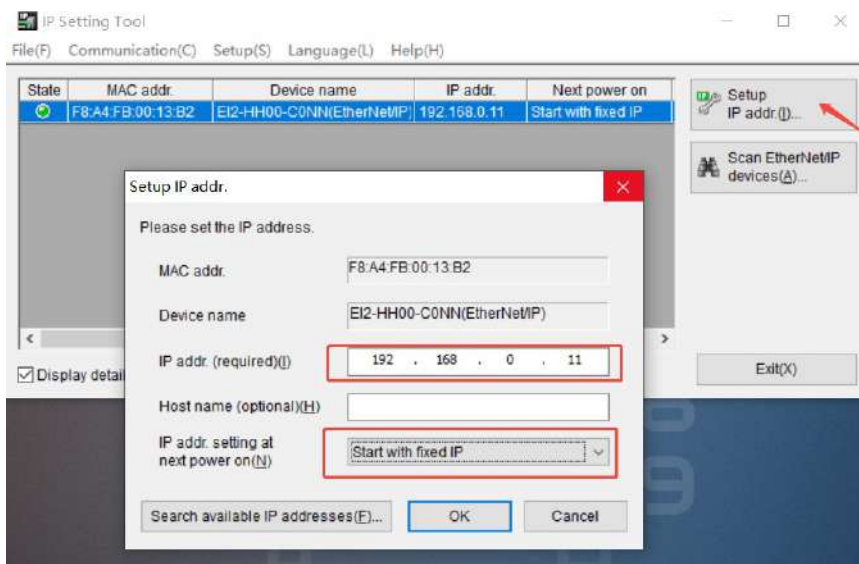

Figure 5-7-3Setting IP address

Suggestion:

Since the module does not have an IP address by default, configure the PC's network adapter IPv4 settings to be in the same subnet as the IP address you intend to assign to the module before setting the module's IP.

4、 Install EDS document

Open the KV STUDIO software, create a new project, and double-click "EtherNet/IP" in the project device tree to open the EtherNet/IP settings window. In the EtherNet/IP settings window, go to the menu bar and select "EDS File" > "Register," as shown in Figure 5-7-4.

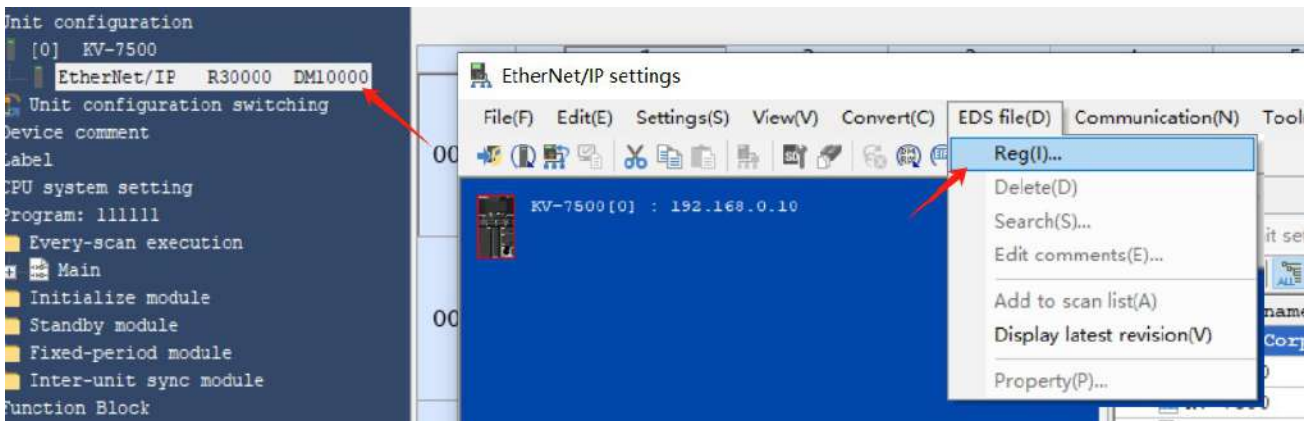

Figure 5-7-4Install EDS document

5. New project and equipment configuration

Open KV STUDIO software, create a new project, and double-click “EtherNet/IP” in the project device tree to open the EtherNet/IP settings window. Manually add EI2-HH00-C1NN to the EtherNet/IP list, as shown in Figure 5-7-5.

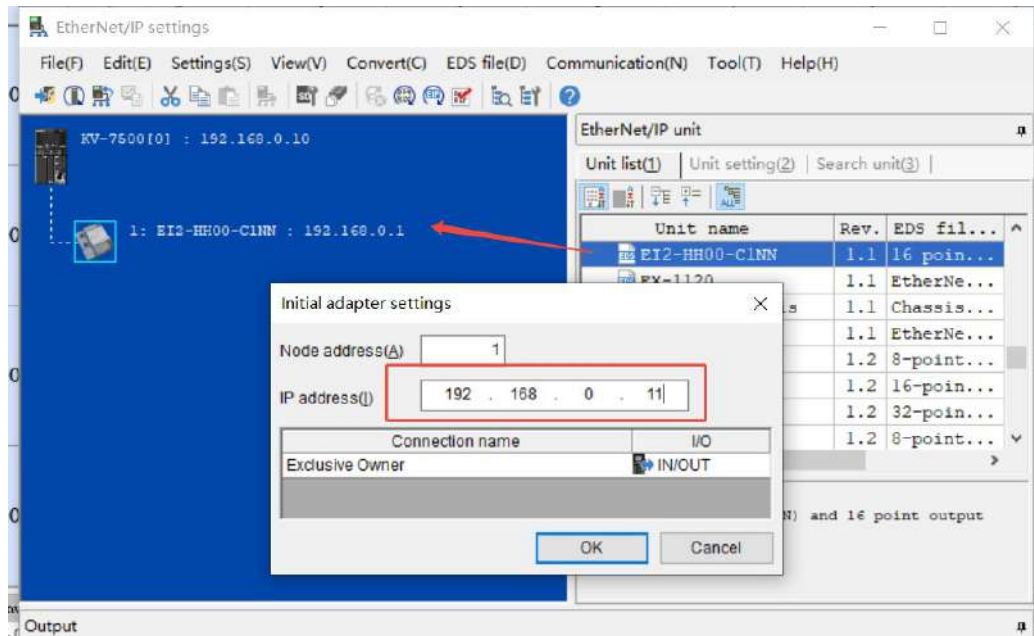

Figure 5-7-5 Manually add EI2-HH00-C1NN To EtherNet/IP List

Scan the EI2-HH00-C1NN adapter online (first ensure that the online module and the PLC are on the same subnet). In the EtherNet/IP settings window, go to the menu bar and select “File” > “Auto Configuration,” as shown in Figure 5-7-6.

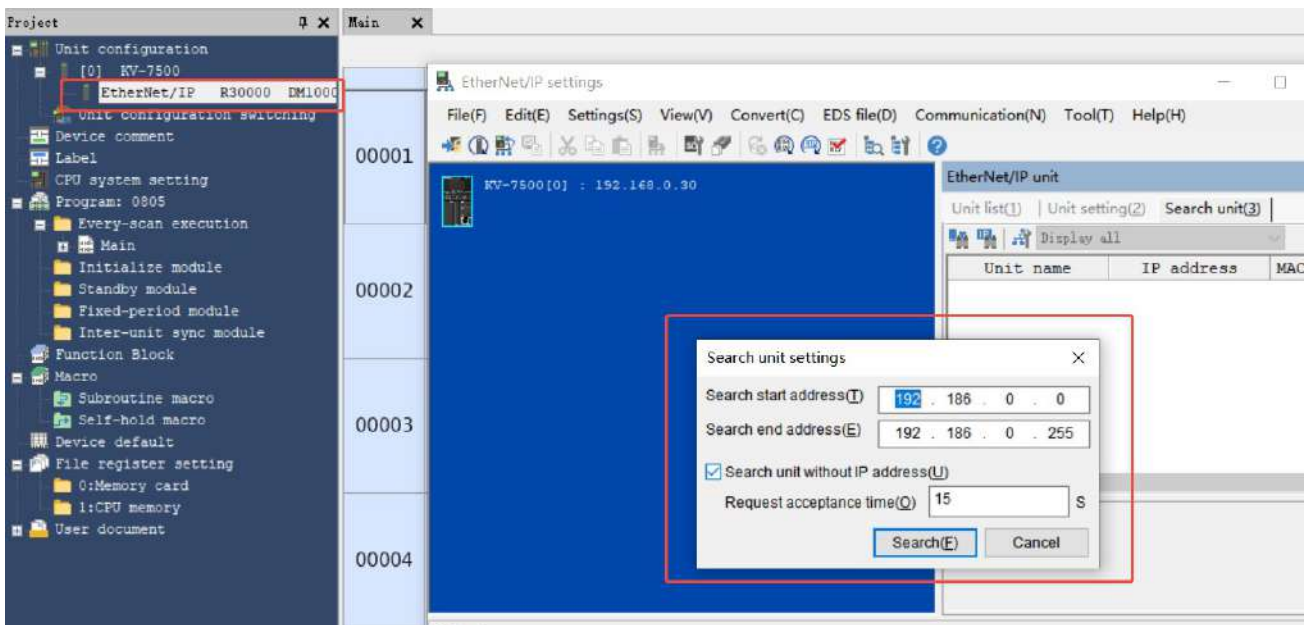

Figure 5-7-6 Online EI2-HH00-C1NN Module scan up

Apply configuration and download configuration and program to PLC and monitor the module operation status, as shown in Figure 5-7-7 shown.

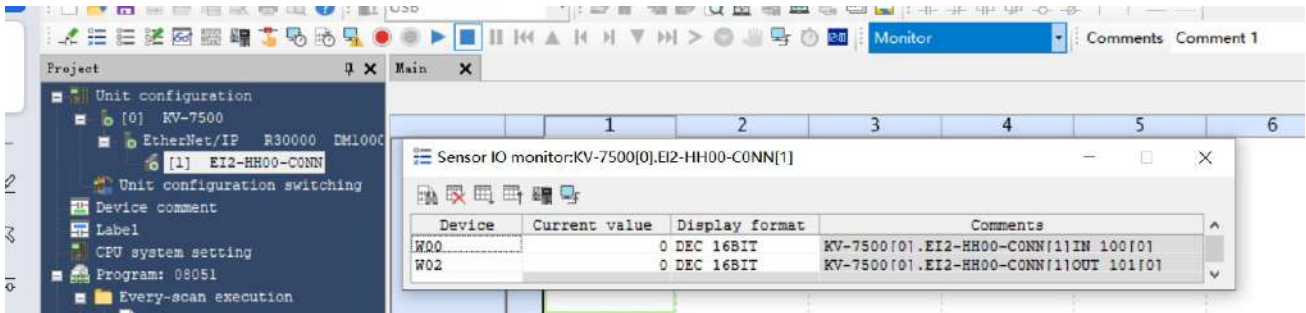

Figure 5-7-7Run and monitor

5.7.2 Machine Expert and EtherNet/IP protocol IO Module connections and configuration

1. Communication connection diagram, as shown in Figure 5-7-8Shown

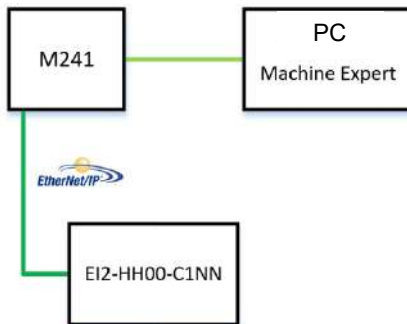

Figure 5-7-8Communication connection diagram

2、 Hardware configuration as shown in Table 5-7-2Shown

Table 5-7-2Hardware Configuration Table

hardware	quantity	Remark
Programming Computer	1	Machine Expert,IP Setting Toolsoftware
PLC	1	M241
EI2-HH00-C1NN	1	EtherNet/IP Protocol 16DI/16DOModules
Communication line	several	

Module IP Address Settings

Open IP Setting Tool software, select the network card connected to the module, and scan the online IO Module, as shown in Figure 5-7-9shown.

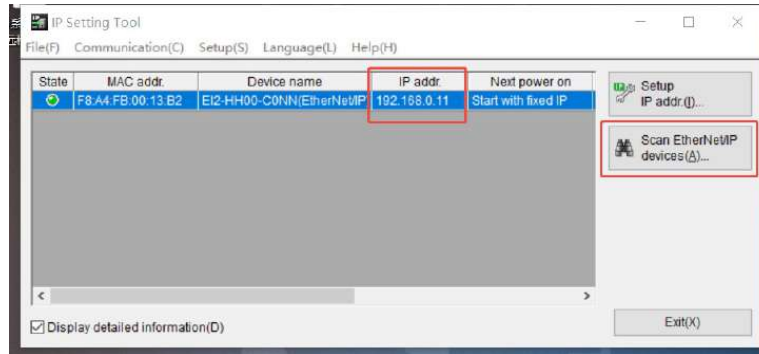

Figure 5-7-9Scan Online IOModules

Select the module in the scan list whose IP address needs to be modified (Note: the module is set to BOOTP by default at the factory and has no IP address. After setting the IP address, be sure to select "Static IP" as the startup mode), as shown in Figure 5-7-10shown.

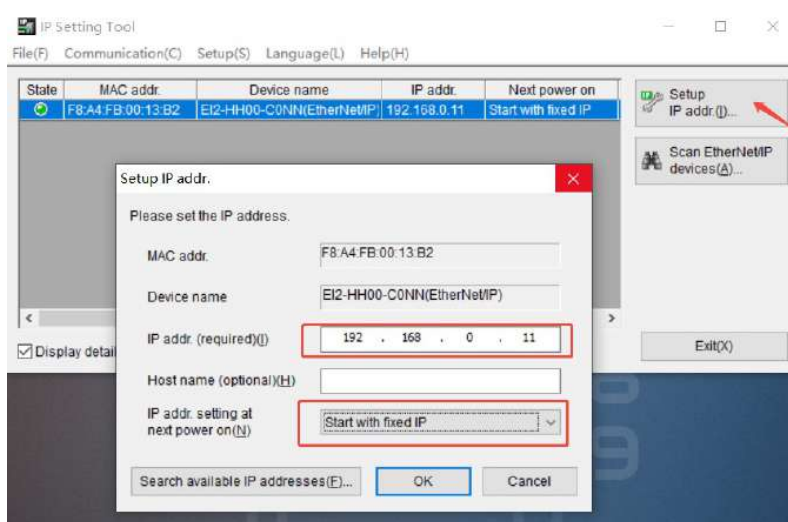

Figure 5-7-10Setting IPaddress

Recommendation: The module does not have an IP address by default. Before configuring the module's IP address, first set the PC's network adapter IPv4 to the same subnet as the IP address you intend to assign to the module.

4. Install EDS document

Open Machine Expert V2.0Programming software, select "Tools" > "Device Repository" in the menu bar, and select "Install" in the Device Repository window, as shown in Figure 5-7-2As shown, select EDS file "EI2-HH00-C1NN" and confirm the installation.

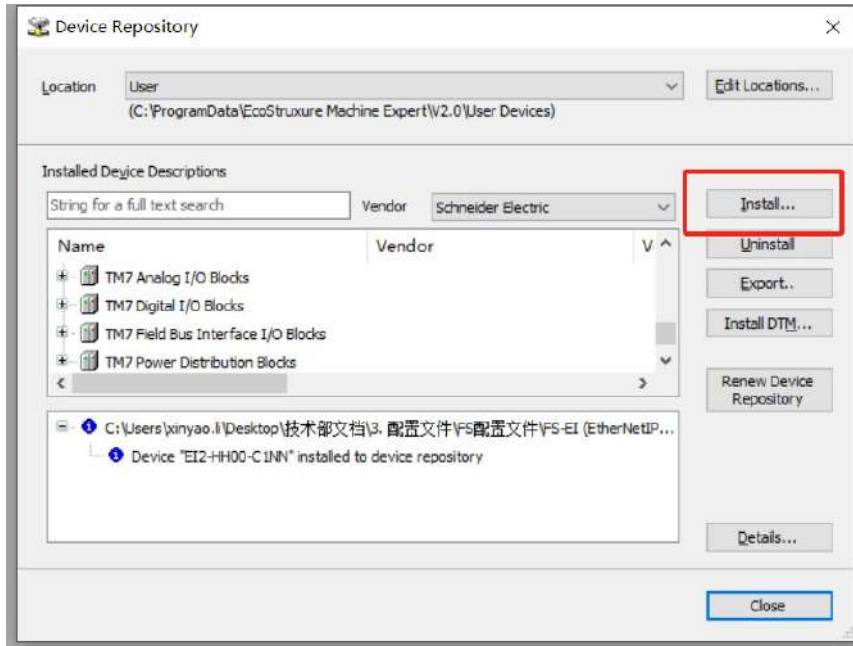

Figure 5-7-11 Install EDSdocument

5. New project and equipment configuration

Open Machine Expert V2.0, create a project, and right-click "EtherNET_1" Select "Add Device", as shown in Figure 5-7-12As shown,

In the Add Device window, select "Protocol Manager" > "Industrial Ethernet Manager", as shown in Figure 5-7-13As shown, right-click "_" under the device tree(Industrial Ethernet Manager)">"Add Device", in the device window, select "DECOWELL AUTOMATION CO.,LTD", and select "EI2-HH00-C1NN", as shown in Figure 5-7-14shown.

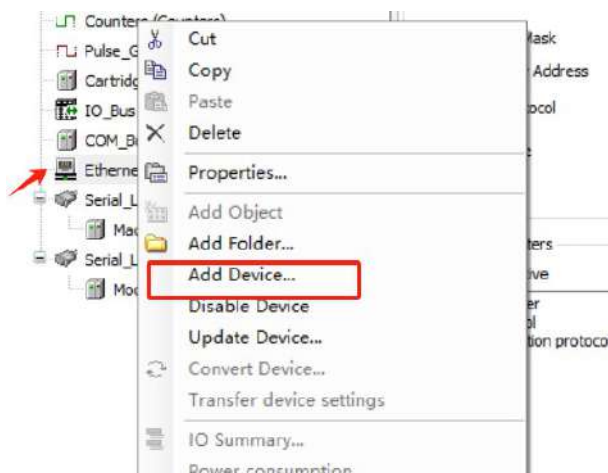

Figure 5-7-12 Add a device

Name	Vendor	Version	Description
Protocol Managers			
Industrial Ethernet Manager	Schneider Electric	1.0.12.35	This service allows to manage the I
Fieldbuses			

Figure 5-7-13 Adding Industrial Ethernet Manager

String for a full text search

Vendor: DECOWELL AUTOMATION CO.,LTD.

Name	Vendor	Version
EI2-0S00-N1NN	DECOWELL AUTOMATION CO.,LTD.	Major Revision=16#1, Minor Revisio
EI2-8800-C0NN	DECOWELL AUTOMATION CO.,LTD.	Major Revision=16#1, Minor Revisio
EI2-8800-C1NN	DECOWELL AUTOMATION CO.,LTD.	Major Revision=16#1, Minor Revisio
EI2-8800-C2NN	DECOWELL AUTOMATION CO.,LTD.	Major Revision=16#1, Minor Revisio
EI2-HH00-C0NN	DECOWELL AUTOMATION CO.,LTD.	Major Revision=16#1, Minor Revisio
EI2-HH00-C1NN	DECOWELL AUTOMATION CO.,LTD.	Major Revision=16#1, Minor Revisio
EI2-S000-CNNN	DECOWELL AUTOMATION CO.,LTD.	Major Revision=16#1, Minor Revisio
RB-1120	DECOWELL AUTOMATION CO.,LTD.	Major Revision=16#1, Minor Revisio

Group by category
 Display all versions (for experts only)
 Display outdated versions

Figure 5-7-14 Add EI2-HH00-C1NN

Configure the parameters of EI2-HH00-C1NN by double-clicking “EI2-HH00-C1NN” in the device tree. Set the IP address to a static IP address, as shown in Figure 5-7-15.

Figure 5-7-15 Configuration IPAddress

To view the I/O address mapping, double-click “EI2-HH00-C1NN” in the device tree and

navigate to the EtherNet/IP I/O Mapping section, as shown in Figure 5-7-16.

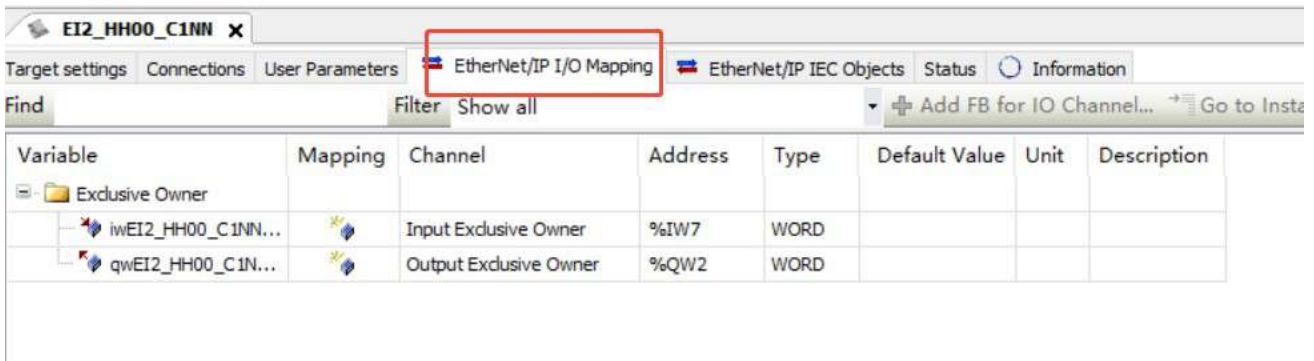

Figure 5-7-16 IOAddress Mapping

5.7.3 CODESYS and EtherNet/IP Protocol IOModule connections and configuration

1. Communication connection diagram, as shown in Figure 5-7-8Shown

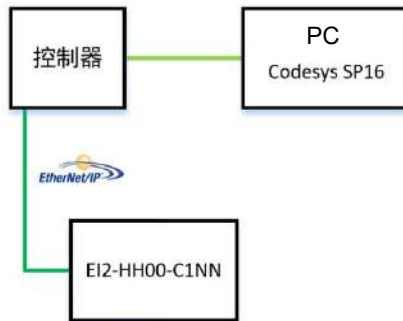

Figure 5-7-17Communication connection diagram

2、Hardware configuration as shown in Table 5-7-3Shown

Table 5-7-3Hardware Configuration Table

hardware	quantity	Remark
Programming Computer	1	CodesysSP16,IP Setting Toolsoftware
PLC	1	
EI2-HH00-C1NN	1	EtherNet/IP Protocol 16DI/16DOModules
Communication line	several	

Module IP Address Settings

Open IP Setting Tool software, select the network card connected to the module, and scan the online IO Module, as shown in Figure 5-7-18shown.

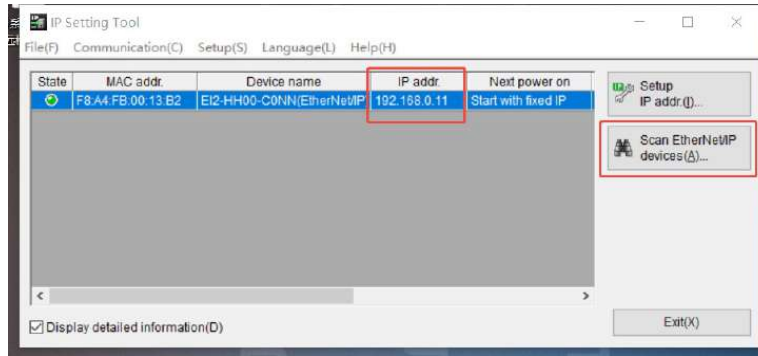

Figure 5-7-18 Scan Online IO Modules

Select the module in the scan list whose IP address needs to be modified (Note: the module is set to BOOTP by default at the factory and has no IP address. After setting the IP address, be sure to select "Static IP" as the startup mode), as shown in Figure 5-7-19 shown.

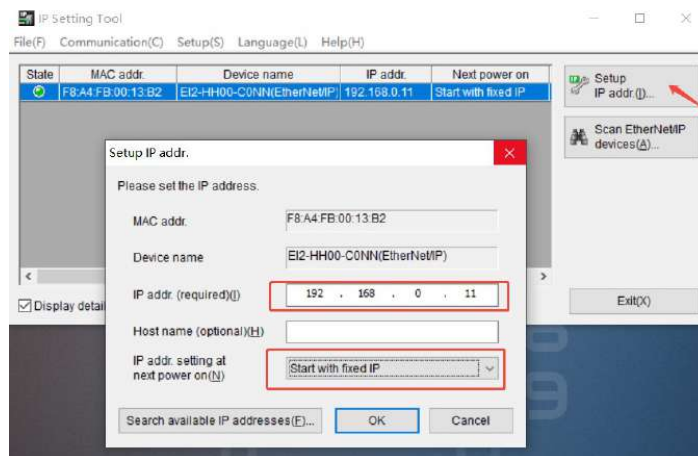

Figure 5-7-19 Setting IP address

Recommendation: The module does not have an IP address by default. Before configuring the module's IP address, first set the PC's network adapter IPv4 to the same subnet as the IP address you intend to assign to the module.

4. Install EDS document

Open the CODESYS SP16 programming software, go to the menu bar and select "Tools" > "Device Repository." In the Device Repository window, click "Install" as shown in Figure 5-7-20. Then, select "General Version" > "EI2-HH00-C1NN" from the EDS folder and confirm the installation.

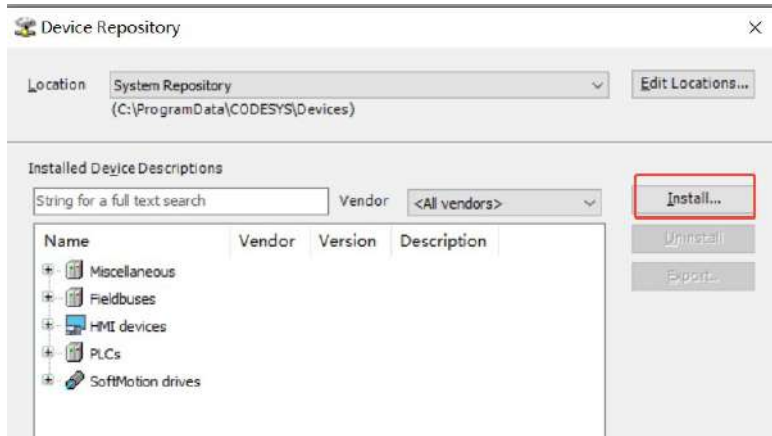

Figure 5-7-20 Install EDS document

5. New project and equipment configuration

Open CODESYS SP16, create a new project, and right-click on “Device” in the device tree, then select “Add Device.” In the Add Device window, select “Ethernet,” as shown in Figure 5-7-21.

Next, right-click on “Ethernet” in the device tree and select “Add Device.” In the Add Device window, choose “EtherNet/IP Scanner,” as shown in Figure 5-7-22.

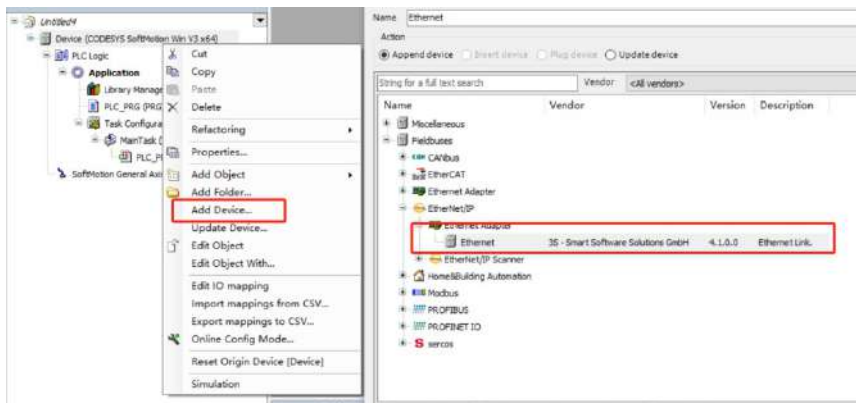

Figure 5-7-21 Adding an Ethernet Adapter



Figure 5-7-22 Add Ethernet IP scanner

Configure the network card of the Ethernet adapter, double-click "Ethernet" under the

device tree, open the page and select the network card that needs to communicate with the EtherNet/IP slave, as shown in Figure 5-7-23 shown.

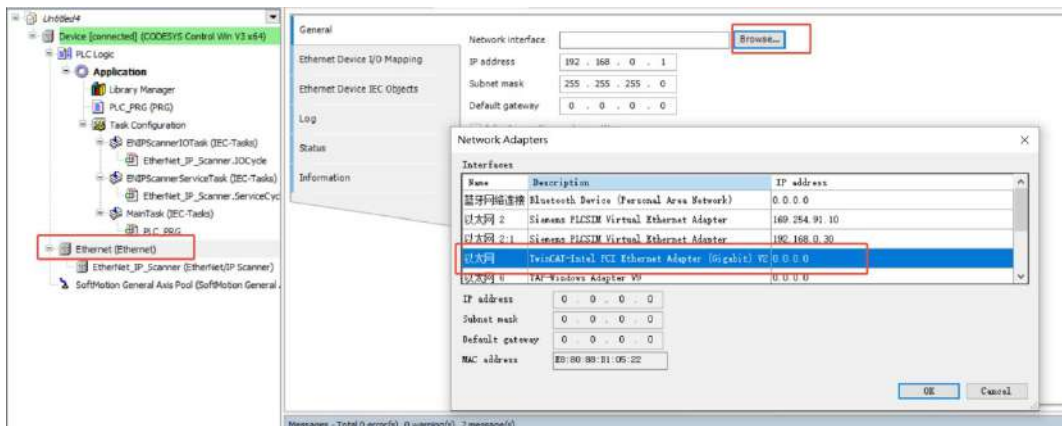

Figure 5-7-23 Configuring the Ethernet Adapter Network Card

Right-click the "EtherNet_IP_Scanner"Select "Add Device", select "EI2-HH00-C1NN", as shown in Figure 5-7-24 shown.

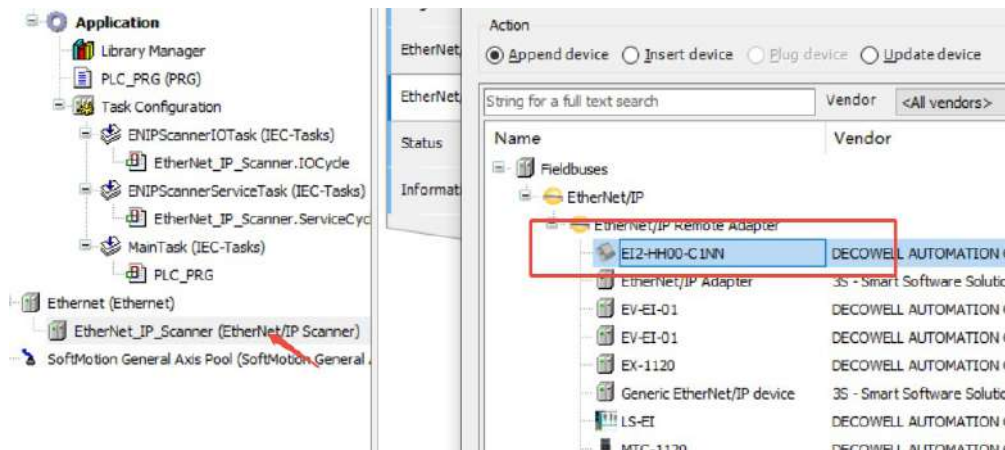

Figure 5-7-24 Add EI2-HH00-C1NNModules

Configure the IP address of the EI2-HH00-C1NN adapter by double-clicking "EI2-HH00-C1NN" in the device tree. Enter the IP address (make sure it matches the actual IP address set on the module), as shown in Figure 5-7-25.

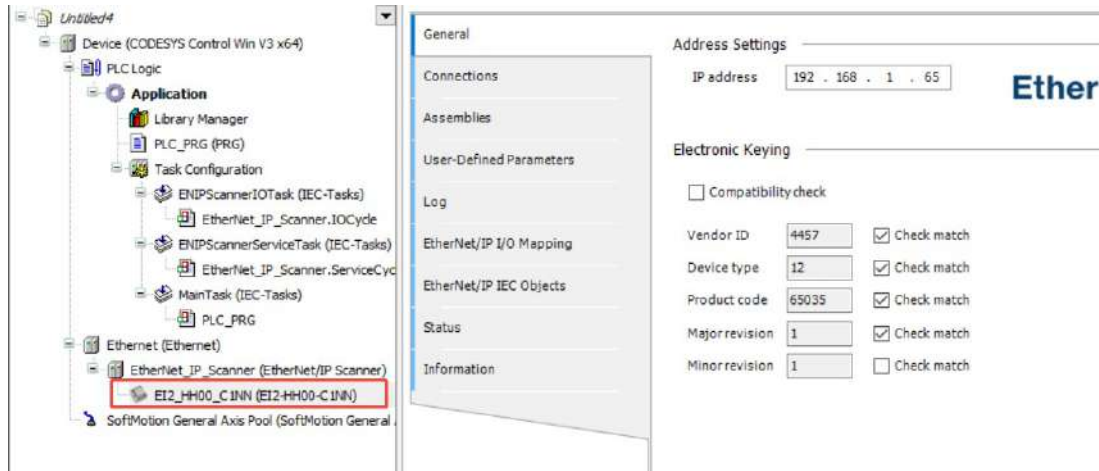

Figure 5-7-25 Configuration EI2-HH00-C1NN Module IP Address

To view the I/O address mapping, double-click “EI2-HH00-C1NN” in the device tree and go to the EtherNet/IP I/O Mapping section, as shown in Figure 5-7-26.

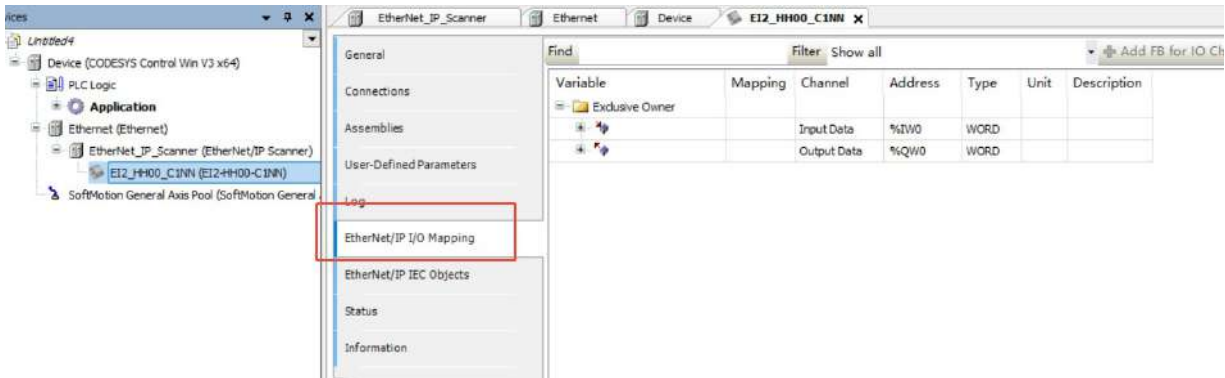

Figure 5-7-26 View IO Address Mapping

5.7.4 Sysmac Studio and EtherNet/IP Protocol IO Module connections and configuration

1. Communication connection diagram, as shown in Figure 5-7-27 Shown

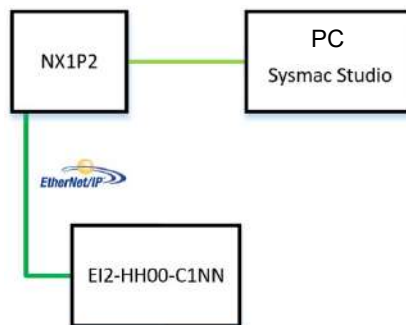

Figure 5-7-27 Communication connection diagram

2. Hardware configuration as shown in Table 5-7-4 Shown

Table 5-7-4 Hardware Configuration Table

hardware	quantity	Remark
Programming Computer	1	Sysmac Studio, IP Setting Tool software
NX1P2	1	
EI2-HH00-C1NN	1	EtherNet/IP Protocol 16DI/16DO Modules
Communication line	several	

Module IP Address Settings

Open IP Setting Tool software, select the network card connected to the module, and scan the online IO Module, as shown in Figure 5-7-28 shown.

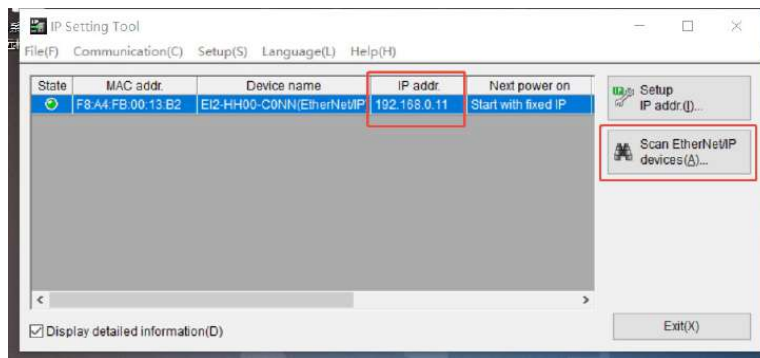

Figure 5-7-28 Scan Online IO Modules

Select the module in the scan list whose IP address needs to be modified (Note: the module is set to BOOTP by default at the factory and has no IP address. After setting the IP address, be sure to select "Static IP" as the startup mode), as shown in Figure 5-7-29 shown.

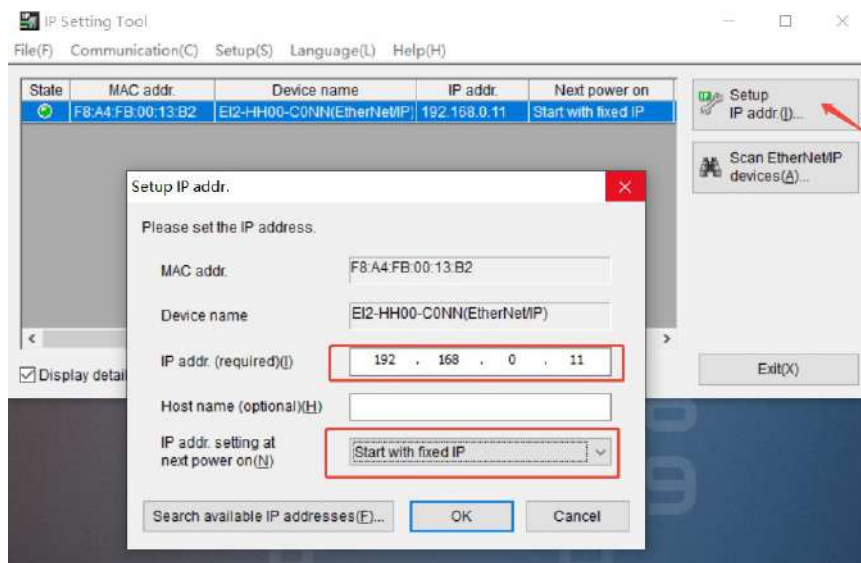

Figure 5-7-29 Setting IP Address

Recommendation: The module does not have an IP address by default. Before configuring the module's IP address, first set the PC's network adapter IPv4 to the same subnet as the IP address you intend to assign to the module.

4. New project and equipment configuration

Open the Sysmac Studio programming software to create a project, and configure the EtherNet/IP port with a fixed IP address (matching the actual PLC port IP), as shown in Figure 5-7-30.

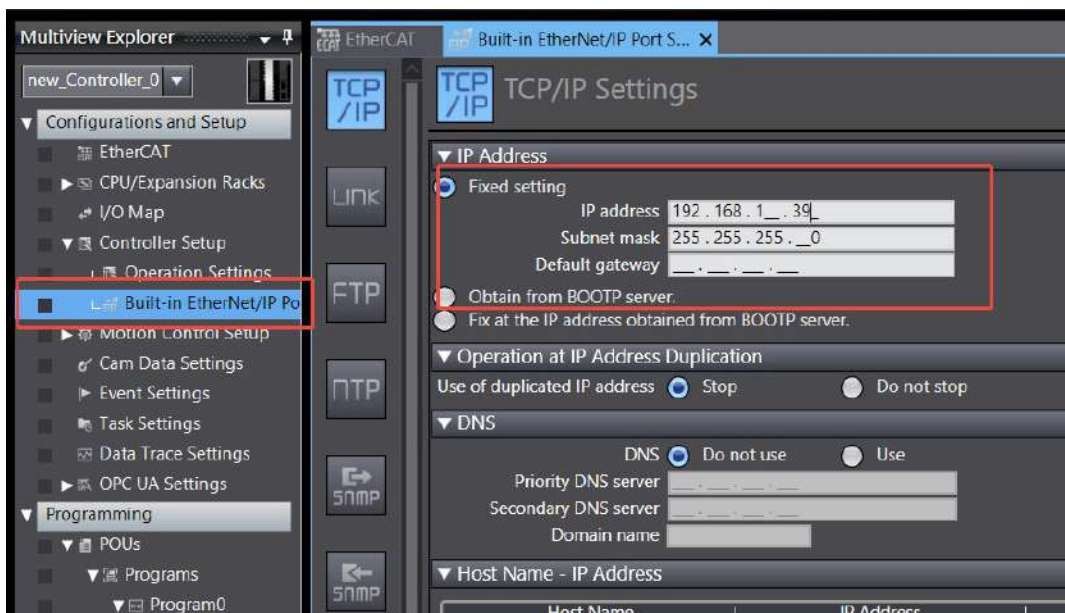

Figure 5-7-30 EtherNet/IP Port Settings

Create all variables, create input and output variables in the global variables, and the length of the variables must be consistent with the actual

The input and output byte lengths in the module are consistent, as shown in the figure 5-7-31 shown.

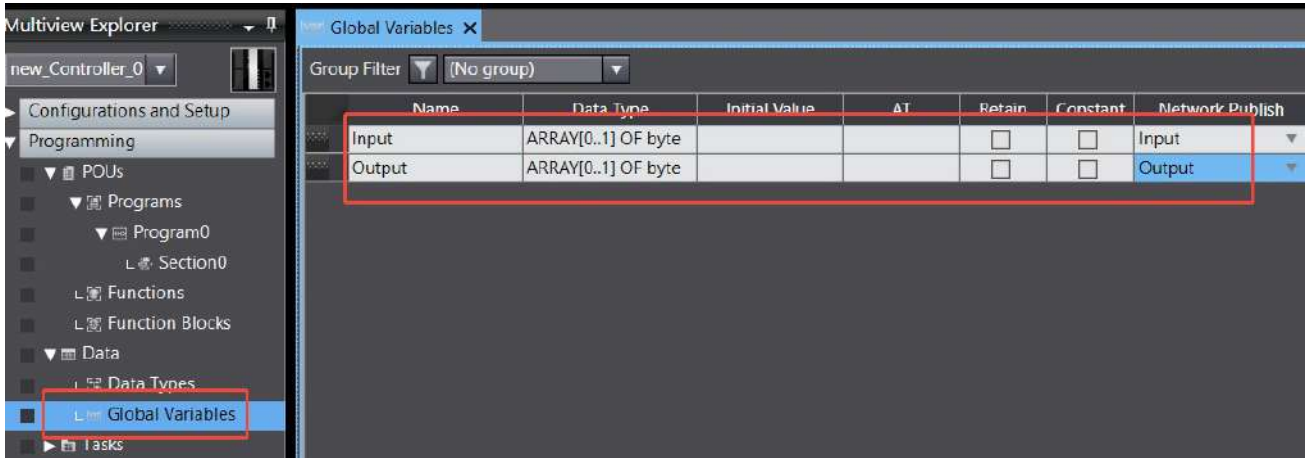

Figure 5-7-31 Creating Global Variables

In the menu bar, select “Tools” > “EtherNet/IP Connection Settings”. In the EtherNet/IP List window, double-click the node address to open the EtherNet/IP Port Connection Settings window, as shown in Figure 5-7-32.

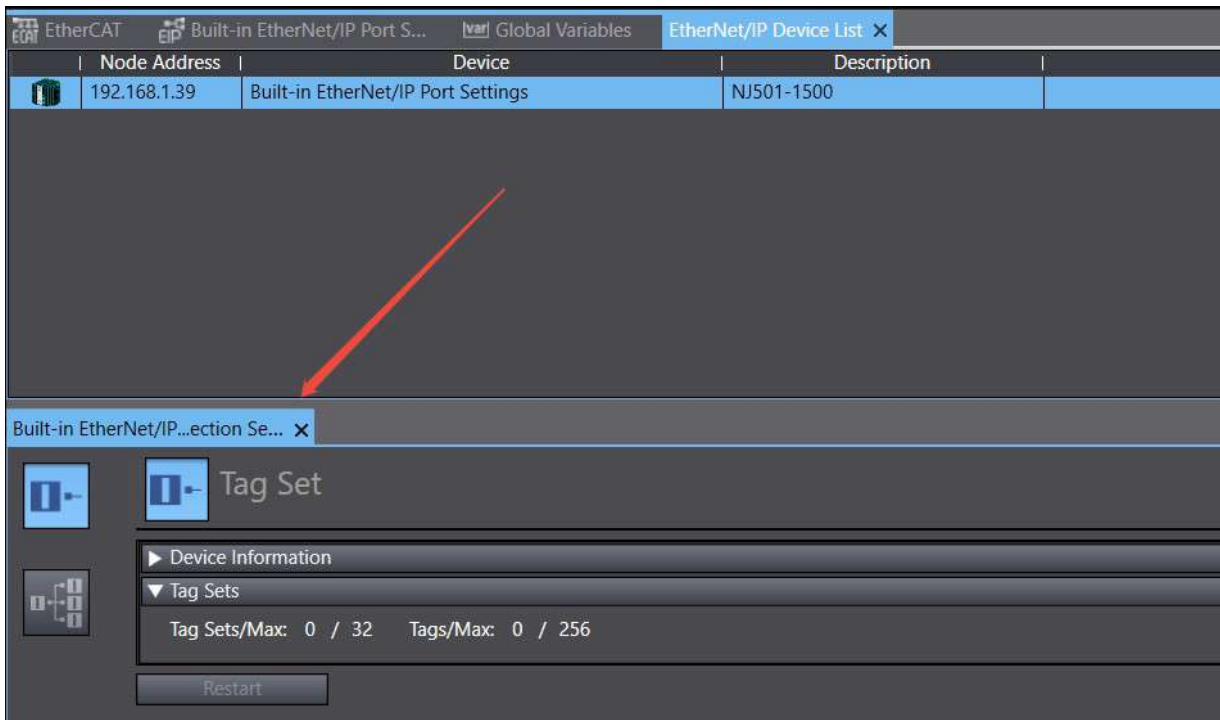

Figure 5-7-32 Open the built-in EtherNet/IP port setting connection setting window

Register variables. In the built-in EtherNet/IP port setting connection setting window, select the "Tag Group" window and click "Register All" to register the newly created global variables, as shown in Figure 5-7-33 shown.

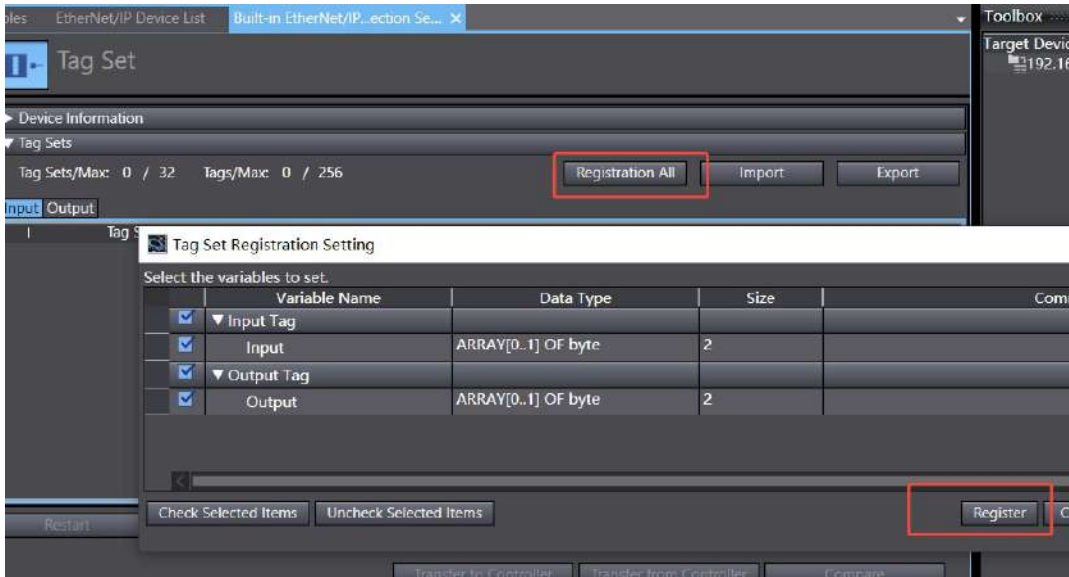

Figure 5-7-33 Global variable registration

To install the EDS file, in the opened Built-in EtherNet/IP Port Connection Settings window, right-click on the blank area of the toolbox on the right and select “Show EDS Library”, as shown in Figure 5-7-34. In the EDS Library window, select “Install” and open the EDS file to be installed, as shown in Figure 5-7-35.

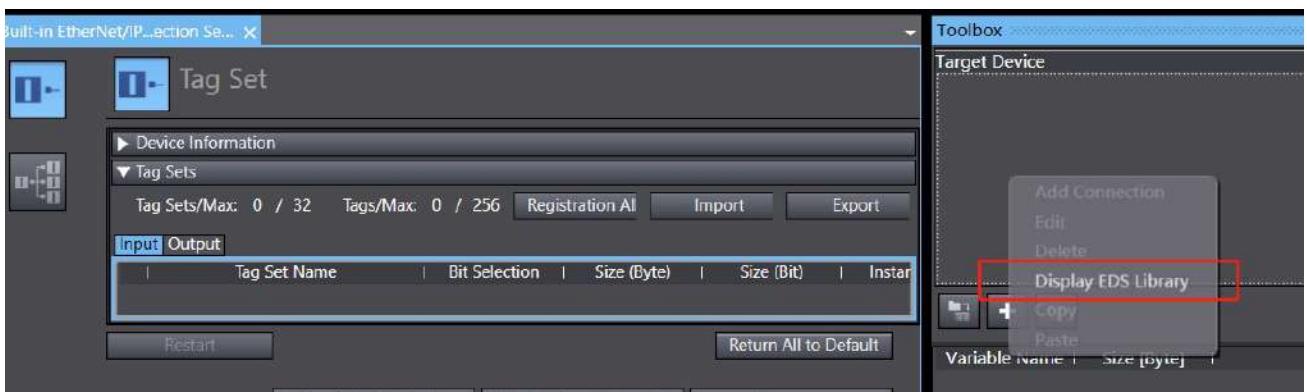

Figure 5-7-34 Display EDS Library

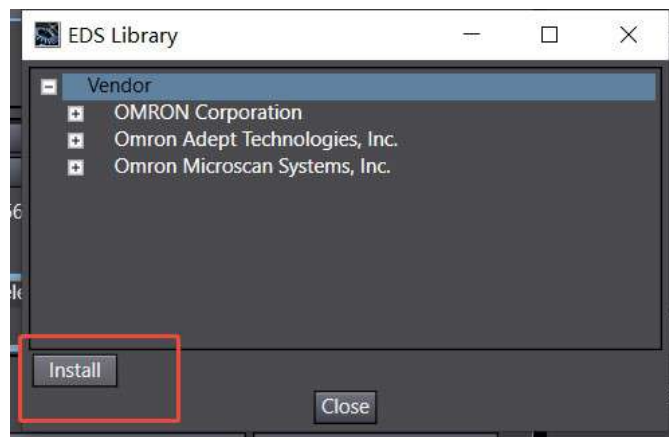

Figure 5-7-35 Install EDS document

Add the device to be communicated with and configure its parameters. In the toolbox, select "Add Target Device", as shown in Figure 5-7-36. The user needs to enter the EtherNet/IP slave IP address, slave model, and revision version. After completion, click the "Add" button at the lower left of the dialog box.

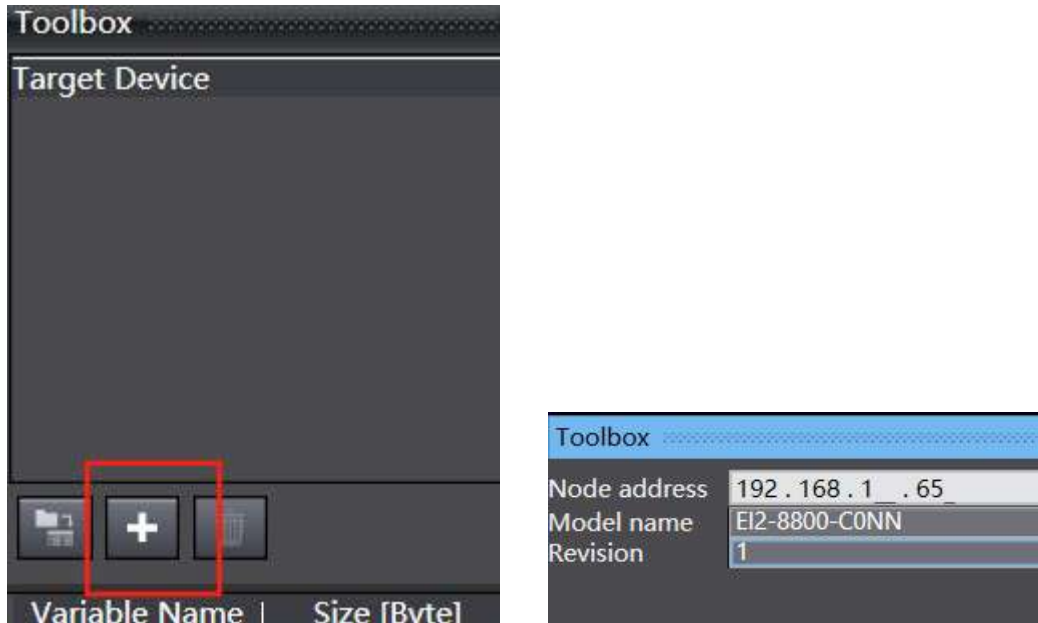

Figure 5-7-36 Add target device

In the toolbox, set the target device "192.168.1.65 EI2-HH00-C1NNVersion 1" and drag it to the connection, as shown in Figure 5-7-37As shown,

Configure the target device parameters, EI2-HH00-C1NN Enter the target variable as 100, the output target variable is 101, the input and output byte sizes are both 10, select the registered global variable as the starting variable, as shown in Figure 5-7-38As shown;

Switch the PLC to online mode and then to program mode, then select "Transfer to Controller", as shown in Figure 5-7-39.

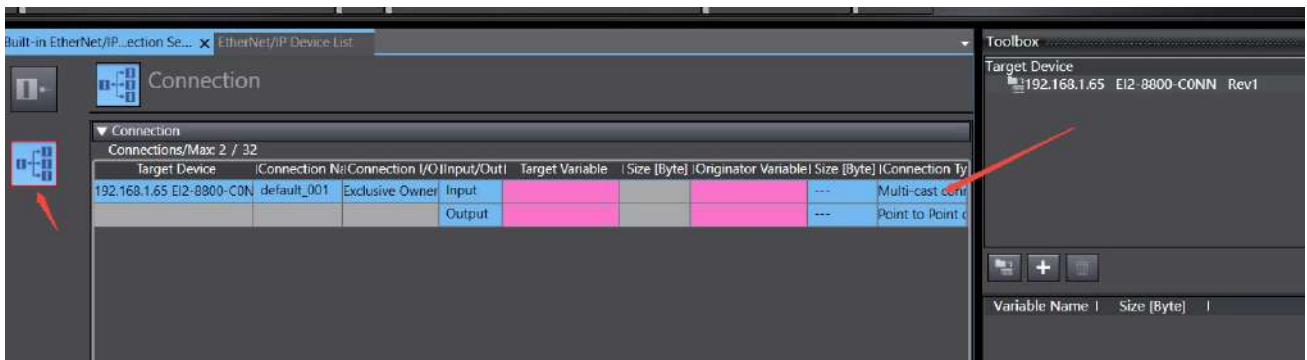

Figure 5-7-37 Adding a connected device

Target Device	Connection No	Connection I/O	Input/Out	Target Variable	Size [Byte]	Originator Variable	Size [Byte]	Connection Type
192.168.1.65 E12-8800-CON	default_002	Exclusive Owner	Input	100	2	Input	2	Multi-cast
			Output	101	2	Output	2	Point to Point

Figure 5-7-38 Configure target device parameters

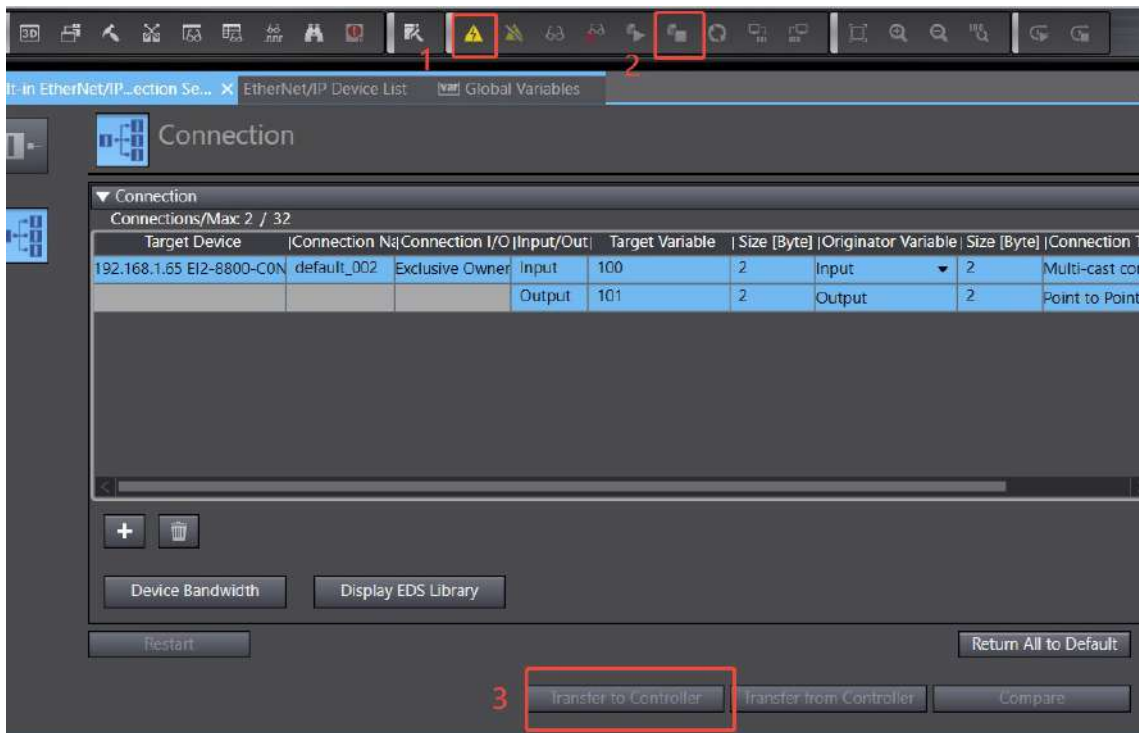

Figure 5-7-39 EtherNet/IP Configuration transfer to controller

Appendix

FS Series product ordering information

FS integrated-PROFINET communication protocol digital input and output module		
Product Model	Product Description	Order Number
PN-8800-C0NN	PROFINET 8-channel digital input (NPN & PNP) 8-channel digital output (NPN)	00-01-01
PN-8800-C1NN	PROFINET 8-channel digital input (NPN & PNP) 8-channel digital output (PNP)	00-01-02
PN-8800-C2NN	PROFINET 8-channel digital input (NPN & PNP) 8-channel digital output (relay)	00-01-03
PN-HH00-C0NN	PROFINET 16-channel digital input (NPN & PNP) 16-channel digital output (NPN)	00-01-04
PN-HH00-C1NN	PROFINET 16-channel digital input (NPN & PNP) 16-channel digital output (PNP)	00-01-05
PN-S000-CNNN	PROFINET 32-channel digital input (NPN & PNP)	00-01-08
PN-0S00-N0NN	PROFINET 32 digital outputs (NPN)	00-01-09
PN-0S00-N1NN	PROFINET 32 digital outputs (PNP)	00-01-10
FS integrated-EtherCAT communication protocol digital input and output module		
Product Model	Product Description	Order Number
EC-8800-C0NN	EtherCAT 8-channel digital input (NPN & PNP) 8-channel digital output (NPN)	00-02-01
EC-8800-C1NN	EtherCAT 8-channel digital input (NPN & PNP) 8-channel digital output (PNP)	00-02-02
EC-8800-C2NN	EtherCAT 8-channel digital input (NPN & PNP) 8-channel digital output (relay)	00-02-03
EC-HH00-C0NN	EtherCAT 16-channel digital input (NPN & PNP) 16-channel digital output (NPN)	00-02-04

EC-HH00-C1NN	EtherCAT 16-channel digital input (NPN & PNP) 16-channel digital output (PNP)	00-02-05
EC-S000-CNNN	EtherCAT 32-channel digital input (NPN & PNP)	00-02-08
EC-0S00-N0NN	EtherCAT 32-channel digital output (NPN)	00-02-09
EC-0S00-N1NN	EtherCAT 32-channel digital output (PNP)	00-02-10
FS integrated-CC-Link communication protocol digital input and output module		
Product Model	Product Description	Order Number
CL-8800-C0NN	CC-LINK 8-way digital input (NPN & PNP) 8-way digital output (NPN)	00-03-01
CL-8800-C1NN	CC-LINK 8-way digital input (NPN & PNP) 8-way digital output (PNP)	00-03-02
CL-8800-C2NN	CC-LINK 8-way digital input (NPN & PNP) 8-way digital output (relay)	00-03-03
CL-HH00-C0NN	CC-LINK 16-channel digital input (NPN & PNP) 16-channel digital output (NPN)	00-03-04
CL-HH00-C1NN	CC-LINK 16-channel digital input (NPN & PNP) 16-channel digital output (PNP)	00-03-05
CL-S000-CNNN	CC-LINK 32-channel digital input (NPN & PNP)	00-03-07
CL-0S00-N0NN	CC-LINK 32-channel digital output (NPN)	00-03-08
CL-0S00-N1NN	CC-LINK 32-channel digital output (PNP)	00-03-09
FS integrated-DeviceNet communication protocol digital input and output module		
Product Model	Product Description	Order Number
DN-8800-C0NN	DEVICENET 8-channel digital input (NPN & PNP) 8-channel digital output (NPN)	00-04-01
DN-8800-C1NN	DEVICENET 8-channel digital input (NPN & PNP) 8-channel digital output (PNP)	00-04-02
DN-8800-C2NN	DEVICENET 8-channel digital input (NPN & PNP) 8-channel digital output (relay)	00-04-03

DN-HH00-C0NN	DEVICENET 16-channel digital input (NPN & PNP) 16-channel digital output (NPN)	00-04-04
DN-HH00-C1NN	DEVICENET 16-channel digital input (NPN & PNP) 16-channel digital output (PNP)	00-04-05
DN-S000-CNNN	DEVICENET 32-channel digital input (NPN & PNP)	00-04-08
DN-0S00-N0NN	DEVICENET 32-channel digital output (NPN)	00-04-09
DN-0S00-N1NN	DEVICENET 32-channel digital output (PNP)	00-04-10
FS integrated- CC-Link IE Field Basic communication protocol digital input and output module		
Product Model	Product Description	Order Number
CI-8800-C0NN	CC-Link IE Field Basic 8-channel digital input (NPN & PNP) 8-channel digital output (NPN)	00-06-01
CI-8800-C1NN	CC-Link IE Field Basic 8-channel digital input (NPN & PNP) 8-channel digital output (PNP)	00-06-02
CI-8800-C2NN	CC-Link IE Field Basic 8-channel digital input (NPN & PNP) 8-channel digital output (relay)	00-06-03
CI-HH00-C0NN	CC-Link IE Field Basic 16-channel digital input (NPN & PNP) 16-channel digital output (NPN)	00-06-04
CI-HH00-C1NN	CC-Link IE Field Basic 16-channel digital input (NPN & PNP) 16-channel digital output (PNP)	00-06-05
CI-S000-CNNN	CC-Link IE Field Basic 32-channel digital input (NPN & PNP)	00-06-06
CI-0S00-N0NN	CC-Link IE Field Basic 32-channel digital output (NPN)	00-06-07
CI-0S00-N1NN	CC-Link IE Field Basic 32-channel digital output (PNP)	00-06-08
FS integrated-PROFINET communication protocol digital input and output module		
Product Model	Product Description	Order Number
PN2-8800-C0NN	PROFINET 8-channel digital input (NPN & PNP) 8-channel digital output (NPN)	00-01-11

PN2-8800-C1NN	PROFINET 8-channel digital input (NPN & PNP) 8-channel digital output (PNP)	00-01-12
PN2-8800-C2NN	PROFINET 8-channel digital input (NPN & PNP) 8-channel digital output (relay)	00-01-13
PN2-HH00-C0NN	PROFINET 16-channel digital input (NPN & PNP) 16-channel digital output (NPN)	00-01-14
PN2-HH00-C1NN	PROFINET 16-channel digital input (NPN & PNP) 16-channel digital output (PNP)	00-01-15
PN2-S000-CNNN	PROFINET 32-channel digital input (NPN & PNP)	00-01-18
PN2-0S00-N0NN	PROFINET 32 digital outputs (NPN)	00-01-19
PN2-0S00-N1NN	PROFINET 32 digital outputs (PNP)	00-01-20
FS integrated-EtherNet/IP communication protocol digital input and output module		
Product Model	Product Description	Order Number
EI2-8800-C0NN	EtherNet/IP 8-channel digital input (NPN & PNP) 8-channel digital output (NPN)	00-05-11
EI2-8800-C1NN	EtherNet/IP 8-channel digital input (NPN & PNP) 8-channel digital output (PNP)	00-05-12
EI2-8800-C2NN	EtherNet/IP 8-channel digital input (NPN & PNP) 8-channel digital output (relay)	00-05-13
EI2-HH00-C0NN	EtherNet/IP 16-channel digital input (NPN & PNP) 16-channel digital output (NPN)	00-05-14
EI2-HH00-C1NN	EtherNet/IP 16-channel digital input (NPN & PNP) 16-channel digital output (PNP)	00-05-15
EI2-S000-CNNN	EtherNet/IP 32 digital inputs (NPN & PNP)	00-05-16
EI2-0S00-N0NN	EtherNet/IP 32 digital outputs (NPN)	00-05-17
EI2-0S00-N1NN	EtherNet/IP 32 digital outputs (PNP)	00-05-18