

EX Series Card I/O User Manual

Decowell Reliable partner for intelligent manufacturing

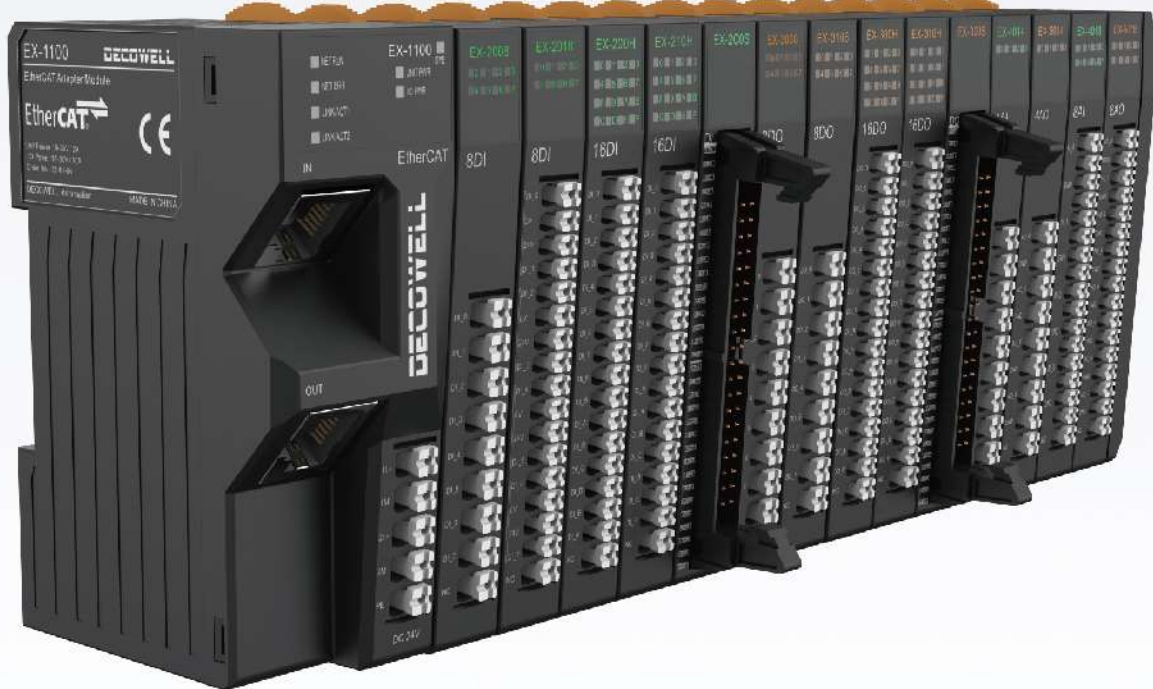

Website: www.wellinkio.com

Email: contact@wellinkio.com

Address: Building 13, Ruichuang Intelligent Manufacturing Park,
No. 19 Lanxin Road, Pukou District, Nanjing

2.3.1 Analog input module	48
2.3.2 Analog output module	52
2.4 Temperature Collection module	57
2.4.1 Thermocouple module	57
2.4.2 Thermal Resistance Module	60
2.5 Function Modules	63
2.5.1 Encoder Module	63
2.6 Communication Module	64
2.6.1 Communication module	64
2.7 Auxiliary Modules	66
2.7.1 Power Module and Terminal Module	66
3 Module Installation	67
3.1 Basic Knowledge	67
3.2 Installation Clearance	68
3.3 INSTALLING I/O Modules	68
3.3.1 Installing the Entire Module Group	68
3.3.2 Adding an I/O Module	69
3.4 Wiring standards and connecting standards	70
4 Module size diagram and wiring diagram	71
4.1 Module size diagram	71
4.1.1 Adapter size diagram	71
4.1.2 I/O Module Dimensions diagram	71
4.1.3 Terminal module size diagram	72
4.2 Module Wiring diagram	73
4.2.1 Adapter wiring diagram	73
4.2.2 Wiring diagram of digital input module	73
4.2.3 Wiring diagram of digital output module	74
4.2.4 Analog input module wiring diagram	75

4.2.5 Analog output module wiring diagram	76
4.2.6 Temperature Module wiring diagram	76
4.2.7 Wiring diagram of Function Modules	77
4.2.8 Communication Module wiring diagram	78
4.2.9 Power Module Wiring Diagram	80
5 EX Remote I/O configuration	81
5.1 Connection between Ex-1100 and PLC	81
5.1.1 Connection and Configuration between TwinCAT2 and EX-1100	81
5.1.2 Connection and Configuration between TwinCAT3 and EX-1100	85
5.1.3 Connection and Configuration of CODESYS and EX-1100	89
5.1.4 Connection and Configuration between Sysmac Studio and EX-1100	93
5.2 Connection between EX-1110 and PLC	98
5.2.1 Connection and Configuration between TIA Portal and EX-1110	98
5.2.2 Connection and Configuration between Step7 smart devices and EX-1110	104
5.2.3 Connection and Configuration between Step7 an Ex-1110	108
5.2.4 Connection and configuration between CODESYS and EX-1110	115
5.3 Connection between Ex-1010 and PLC	122
5.3.1 Connection and Configuration between CX-One and EX-1010	122
5.4	
5.5 Connection between EX-1040 and PLC	130
5.5.1 Connection and Configuration between GX-WORS2 and EX-1040	130
5.6 Connection between EX-1030 and PLC	134
5.6.1 Connection and Configuration between Modbus Poll software and EX-1030	134
5.6.2 Connection and Configuration between Codesys and EX-1030	140
5.6.3 Connection and Configuration between TIA Portal and EX-1030	143
5.7 Connection between EX-1120 and PLC	148
5.7.1 Connection and Configuration between Machine Expert and EX-1120	148
5.7.2 Connection and Configuration between CODESYS and EX-1120	153
5.7.3 Connection and Configuration between Sysmac Studio and EX-1120	160

5.7.4 Connection and configuration between KV STUDIO and EX-1120	167
5.8 Connection between EX-1121 and PLC	172
5.8.1 Connection and Configuration between Machine Expert and EX-1121	172
5.8.2 Connection and Configuration between CODESYS and EX-1121	178
5.8.3 Connection and Configuration between Sysmac Studio and EX-1121	185
5.8.4 Connection and Configuration between RSLogix 5000 and Ex-1121	192
5.8.5 Connection and Configuration between KV STUDIO and EX-1121	200
5.9 Connection between Ex-1112 and PLC	206
5.9.1 Connection and Configuration between TIA Portal and EX-1112	206
5.9.2 Connection and Configuration between Step7 smart devices and EX-1112	211
5.9.3 Connection and Configuration between Step7 and Ex-1112	217
6 Module Application	225
6.1 Module Configuration	225
6.1.1 How many I/O modules can an adapter support	225
6.1.2 Adapter Parameter Setting Problems	227
6.1.3 Maximum output current of the digital output module	227
6.1.4 Differences between system Power Supplies and I/O Power supplies	228
6.1.5 Can the output module control the inductive load	228
6.1.6 DeviceNet Adapter Networking	228
6.1.7 Whether the Thermal resistance/thermocouple module supports filtering configuration	228
6.1.8 Analog input module 2-wire / 3-wire / 4-wire connection method	228
6.1.9 EX-1120/EX-1121 Output Hold Settings	228
6.2 Common communication exceptions and exclusion methods	231
6.2.1 EtherCAT Communication is abnormal	231
6.2.2 PROFINET communication Is Abnormal	232
6.2.3 DeviceNet Communication Is Abnormal	232
6.2.4 CC-link Communication is abnormal	232
6.2.5 Modbus RTU Communication Is Abnormal	232
6.2.6 EtherNet/IP Communication Is Abnormal	232

6.3 Using Modules	234
6.3.1 Encoder Module	234
6.3.2 High-speed pulse output module	234
6.3.3 EX-6311/6301 Free communication module use	236
6.3.4 TIA Portal Configures ex-6321 modules	242
6.3.5 TwinCAT3 configuration EX-6321	245
6.3.6 Setting the IP address of the EX-1121 Adapter	248
The Appendix	252
1. Modbus address table of ex-1030 module	252
2. Order information of remote IO products	254

Introduction

Copyright statement

Copyright © 2020

Nanjing Decowell Automation Co., LTD. All rights reserved. Without the written permission of the Company, no unit or individual is allowed to extract or reproduce the contents of this document in part or in whole, and shall not be transmitted in any form.

DECOWELL WELLINKIO All are trademarks of our company. Other registered trademarks appearing in this document shall be owned by their respective owners.

Due to product version upgrade or other reasons, the contents of this document will be updated from time to time. Except as otherwise agreed, this document is for reference only. All statements, information and recommendations contained in this document do not constitute a warranty of any kind, express or implied.

The scope of this document

This document is applicable to EX series remote I/O systems

Content introduction



This document describes the technical specifications, installation, and commissioning of EX series remote I/O modules. The main contents include:

- System Overview: Mainly introduces EX series remote I/O module product ordering information, product composition, system architecture, product transportation, storage environment and other contents;
- Product Description: Describes the technical parameters of EX series remote I/O modules.
- Installation and Disassembly Guide: Describes the installation and disassembly of EX series remote I/O modules.
- Mechanical and Electrical Drawing: EX remote IO module dimension drawing and electrical wiring diagram;
- Usage Guide: Through examples, the EX series remote I/O module and the communication between the main PLC connection;

Attention

This document describes in detail the use of well-Link's EX series remote I/O modules for those with engineering experience. Nanjing Deckwell shall not be responsible for any consequences arising from the use of this material.

Before using the device, read the precautions carefully and follow the safety precautions and operating procedures for installation and commissioning. See the following symbols for the possible hazards and extent of damage caused by incorrect use of the equipment

 Warning
This marker means
 Attention
This marker means
 Reminder
This marker means

The applicable objects

This manual provides information on the installation and commissioning of EX series remote I/O modules. It is designed for engineers, installers, maintenance personnel, and electricians with automation knowledge.

Recovery and disposal

To ensure that recycling and disposal of used equipment meets environmental requirements, contact an accredited e-waste service.

Online support

In addition to this manual, you can also refer to the official website for more product information.

<http://www.wellinkio.com>

1 Overview of the EX Remote I/O system

1.1 What is a Distributed I/O System

EX series IO is a highly flexible, scalable distributed I/O module for connecting process signals to upper controllers via a fieldbus.

1.2 Modules of an EX Distributed I/O System

EX series remote I/O modules are composed of adapter module, I/O module (digital/analog/function module), power module, and terminal module.

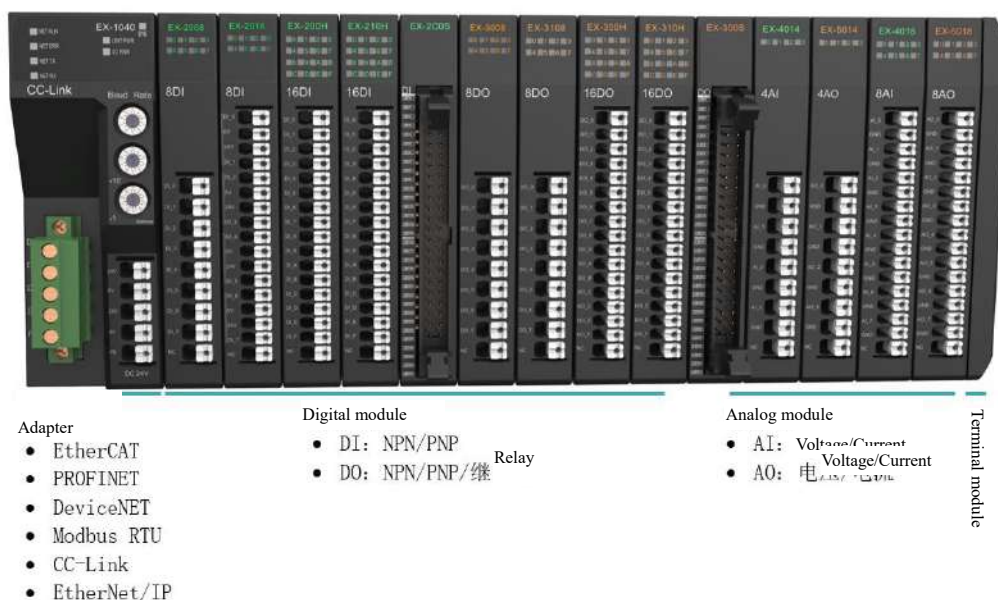

Figure 1-1 EX series I/O system architecture

1.3 Features of the EX distributed I/O Module



Figure 1-2 Features of The EX series I/O modules

1.4 Application Domains of EX Distributed I/O

EX series of distributed I/O modules are widely used in various fields, such as new energy, lithium, non-standard automation, robotics, CNC machine tools, intelligent garage, logistics sorting, educational equipment, environmental protection, heating, etc.

2 EX Remote I/O Module Parameters

2.1 EX Series Adapters

Adapter module can support a variety of bus communication protocols and achieve seamless connection with the mainstream PLC; An adapter module can be connected to a maximum of 32 I/O modules and supports a maximum of 1024 signal points. A variety of status diagnosis functions and status indicators are designed. Screw free terminal, wiring is convenient and reliable, and the design of 45 degree network port, reduce the stress of network port, increase the reliability of the product. Through the buttons on both sides of the module, multiple modules can be fixed to each other, to increase the seismic performance of the system using the standard DIN35 guide rail installation.

2.1.1 DeviceNet Adapter

- DeviceNet Adapter model and order number

Model	Specifications description	The order no.
EX-1010	DeviceNet adapter module	02-01-01
EX-1130	Modbus TCP bus adapter	02-01-11

EX-1030	Modbus RTU adapter module	02-01-03
EX-1100	EtherCAT adapter module	02-01-04
EX-1110	PROFINET adapter module	02-01-05
EX-1040	Cc-link adapter module	02-01-06
EX-1050	CANopen adapter module	02-01-11
EX-1120	EtherNet/IP adapter	02-01-08
EX-1121	EtherNet/IP adapter	02-01-08-1
EX-1140	CC-Link IEFB bus adapter	02-01-09

- DeviceNet Adapter indicator definition

Serial number	Indicator	Instructions	Color	State	Meaning
1	SYS	System indicator	green	Blinking at 1Hz	Communication is normal
				Blinking at 5HZ	I/O lost from the station
				One flash one out	IO module station number assignment failed
				Two flashes one out	I/O module fails to be configured
				out	IO module is not running
2	UNIT PWR	System power indicator	green	on	System power supply is normal
				out	System power supply is not connected or faulty
3	IO PWR	IO power indicator	green	on	I/O power supply is normal
				out	I/O power supply is not

					connected or faulty
4	NET-RUN	Running indicator	green	on	Communication is normal, data transmission is normal
				out	Communication stops. Data transfer stops
5	NET-PWR	Communication interface indicator	red	on	Communication is normal
				out	Communication is disconnected or abnormal
6	NET-ERR	System failure indicator	red	on	I/O module system is faulty
				out	I/O module is running properly

● DeviceNet Adapter communication interface definition

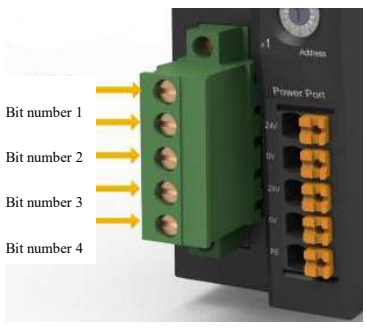
DeviceNet communication interface	Bit number	Signal	Signal definition
	1	V-	Power supply cathode
	2	CAN_L	Data signal negative
	3	SHIELD	Shielding wire
	4	CAN_H	Data signal positive
	5	V+	Power supply positive

● DeviceNet Adapter Dial Settings

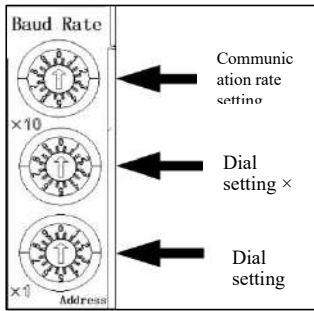

DeviceNet Communication rate setting	
0	125kbps
1	250kbps
2	500kbps

● DeviceNet Adapter parameters

Technical parameters	
Bus protocol	DeviceNet
Address set	0 ~ 63
Expanding the number of I/ OS	32
Maximum input/output bytes	-
Bus rate	125, 250, 500kbps
Transmission distance	500 m (Max)
System side power input	DC24V (18 to 36)
The system side provides current	2 a (Max)
Power input of the I/O port	DC24V (+ / - 20%)
Output current of the I/O port	10 a (Max)
Power consumption	56mA
Conventional parameters	
System side electrical isolation	AC500V
Protection against reverse connection	support
Over current protection	This function is supported by the system, but not by the I/O
Over voltage protection	support

Wire specifications	0.2 ~ 1.5 mm squared
Connection mode	No screw
Overall dimensions	90 x 67 x 34 mm
Weight	240g
Protection grade	IP20
Temperature range	Operating temperature: -10 ~ 55°C, storage temperature: -20 ~ 85°C
Relative humidity	95% no condensation

2.1.2 Modbus TCP adapter

- Modbus TCP bus adapter model and order number

Model	Specifications description	The order no.
EX-1010	DeviceNet adapter module	02-01-01
EX-1130	Modbus TCP bus adapter	02-01-11
EX-1030	Modbus RTU adapter module	02-01-03
EX-1100	EtherCAT adapter module	02-01-04
EX-1102	EtherCAT adapter module	02-01-04-2
EX-1110	PROFINET adapter module	02-01-05
EX-1040	CC-link adapter module	02-01-06
EX-1050	CANopen adapter module	02-01-11
EX-1120	EtherNet/IP adapter	02-01-08
EX-1121	EtherNet/IP adapter	02-01-08-1
EX-1140	CC-Link IEFB bus adapter	02-01-09

2.1.3 Modbus RTU Adapters

- Modbus RTU adapter model and order number

Email: contact@wellinkio.com

model	Specifications description	The order no.
EX-1010	DeviceNet adapter module	02-01-01
EX-1130	Modbus TCP bus adapter	02-01-11
EX-1030	Modbus RTU adapter module	02-01-03
EX-1100	EtherCAT adapter module	02-01-04
EX-1110	PROFINET adapter module	02-01-05
EX-1040	CC-link adapter module	02-01-06
EX-1050	CANopen adapter module	02-01-11
EX-1120	EtherNet/IP adapter	02-01-08
EX-1121	EtherNet/IP adapter	02-01-08-1
EX-1140	CC-Link IEFB bus adapter	02-01-09

- Modbus RTU adapter indicator definition

Serial number	Indicator	Instructions	Color	State	Meaning
1	SYS	System indicator	green	Blinking at 1Hz	Communication is normal
				Blinking at 5HZ	I/O lost from the station
				One flash one out	IO module station number assignment failed
				Two flashes one out	I/O module fails to be configured
				out	IO module is not running
2	UNIT PWR	System power indicator	green	on	System power supply is normal
				out	System power supply is not connected or faulty
3	IO PWR	IO power indicator	green	on	I/O power supply is normal

				out	I/O power supply is not connected or faulty
4	NET-RUN	Running indicator light	green	on	Communication is normal, data transmission is normal
				out	Communication stops. Data transfer stops
5	NET-ERR	System failure indicator	red	on	I/O module system is faulty
				out	I/O module is running properly
6	NETTX	Data transmission indicator light	green	on	Data transmission in progress
				out	Data is stopped or abnormal
7	NETRX	Data reception indicator light	green	flash	Data receiving
				out	Data is stopped or abnormal

- Modbus RTU adapter communication interface definition

- Set

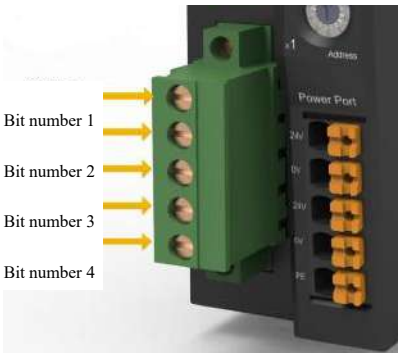
Modbus RTU communication interface	Bit number	signal	Signal definition
	1	A	RS485+
	2	B	RS485-
	3	-	-
	4	-	-
	5	-	-

dip

switches for the Modbus RTU adapter

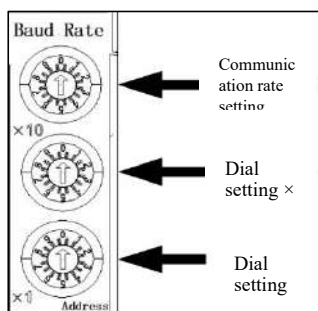

Modbus RTU communication rate setting	
1	115200bps
2	57600bps
3	38400bps
4	19200bps
5	9600 BPS (default)
6	4800bps
7	2400bps
8	1200bps

● Modbus RTU adapter support function code

Function code	function	Functional meaning	note
0x01	Read	Read digital quantity output	For example, the EX-3XXX module
0x02	Read	Read digital quantity input	For example, the EX-2XXX module
0x03	Read	Read analog output	For example, the EX-5XXX module
0x04	Read	Read analog input	For example, the EX-4XXX module
0x05	Write	Write a single numeric quantity	For example, the EX-3XXX module
0x06	Write	Write a single analog quantity	For example, the EX-5XXX module
0x0F	Write	Write multiple numeric quantities	For example, the EX-3XXX module
0x10	Write	Write multiple analog quantities	For example, the EX-5XXX module

● Modbus RTU adapter communication parameters

Technical parameters	
Bus protocol	Modbus RTU
Address set	0 ~ 99
Expanding the number of I/ OS	32
Maximum input/output bytes	Input: 256 Byte/Output: 256 Byte
The bus rate	Optional: 1200/2400/57.6/38.4/19.2/4800/9600 k k k / 115.2 k
Transmission distance	1200 m (Max)
System side power input	DC24V (18 to 36)
The system side provides current	2 a (Max)
Power input of the I/O port	DC24V (+ / - 20%)
Output current of the I/O port	10 a (Max)
Power consumption	69mA
Conventional parameters	
System side electrical isolation	AC500V
Protection against reverse connection	support
Over current protection	This function is supported by the system, but not by the I/O
Over voltage protection	support
Wire specifications	0.2 ~ 1.5 mm squared
Connection mode	No screw
Overall dimensions	90 x 67 x 34 mm
Weight	240g
Protection grade	IP20
Temperature range	Operating temperature: -10 ~ 55°C, storage temperature: -20 ~ 85°C
Relative humidity	95% no condensation

2.1.4 EtherCAT Adapter

- EtherCAT adapter model and order number

Model	Specifications description	The order no.
EX-1010	DeviceNet adapter module	02-01-01
EX-1130	Modbus TCP bus adapter	02-01-11
EX-1030	Modbus RTU adapter module	02-01-03
EX-1100	EtherCAT adapter module	02-01-04
EX-1110	PROFINET adapter module	02-01-05
EX-1040	Cc-link adapter module	02-01-06
EX-1050	CANopen adapter module	02-01-11
EX-1120	EtherNet/IP adapter	02-01-08
EX-1121	EtherNet/IP adapter	02-01-08-1
EX-1140	CC-Link IEFB bus adapter	02-01-09

- EtherCAT adapter indicator definition

Serial number	Indicator	Instructions	Color	State	Meaning
1	SYS	System indicator	green	Blinking at 1Hz	Communication is normal
				Blinking at 5HZ	I/O lost from the station
				One flash one out	IO module station number assignment failed
				Two flashes one out	I/O module fails to be configured
				out	IO module is not running
2	UNIT PWR	System power indicator	green	on	System power supply is normal
				out	System power supply is not connected or faulty

3	IO PWR	IO power indicator	green	on	I/O power supply is normal
				out	I/O power supply is not connected or faulty
4	NET-RUN	Running indicator light	green	on	Communication is normal, data transmission is normal
				flash	Communication initialization complete, pre-run
				one flash	Installation Run Status
				out	Initialization status
5	NET-ERR	System failure indicator	red	on	Communication error
				two flashes	App watchdog timeout
				one flash	Local error
				flash	Configuration error
				out	No Error
6	LINK/ACT1	Indicators of Network Port 1	green	on	The network connection is normal
				out	Network not connected or abnormal
7	LINK/ACT2	Indicators of network Port 2	green	on	The network connection is normal
				out	Network not connected or abnormal

● EtherCAT adapter communication interface definition

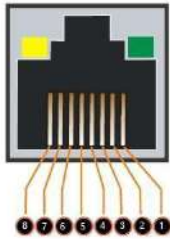
Ethernet interface	Bit number	Signal	Signal definition
 <p>1:TX+ 2:TX- 3:RX+ 4:TERM 5:TERM 6:RX- 7:TERM 8:TERM</p>	1	TX+	Positive end of data transmission
	2	TX-	Negative end of data transmission
	3	RX+	Positive data receiving end
	4	-	-
	5	-	-
	6	RX-	Data receiving negative end

	7	-	-
	8	-	-
	Connector housing	PE	Chassis grounding

- EtherCAT adapter communication parameters

Technical parameters	
Bus protocol	EtherCAT
Address set	According to the main
Expanding the number of I/ O	32
Maximum input/output bytes	Input: 1024 Byte/Output: 1024 Byte
The bus rate	100Mbps
Transmission distance	100m (station to station distance)
System side power input	DC24V (18 to 36)
The system side provides current	2 a (Max)
Power input of the I/O port	DC24V (+ / - 20%)
Output current of the I/O port	10 a (Max)
Power consumption	219mA
Conventional parameters	
System side electrical isolation	AC500V
Protection against reverse connection	support
Over current protection	This function is supported by the system, but not by the I/O
Over voltage protection	support
Wire specifications	0.2 ~ 1.5 mm squared
Connection mode	No screw
Overall dimensions	90 x 67 x 34 mm

The weight of the	240g
Protection grade	IP20
Temperature range	Operating temperature: -10 ~ 55°C, storage temperature: -20 ~ 85°C
Relative humidity	95% no condensation

2.1.5 PROFINET Adapter

- PROFINET adapter model and order number

model	Specifications description	The order no.
EX-1010	DeviceNet adapter module	02-01-01
EX-1130	Modbus TCP bus adapter	02-01-11
EX-1030	Modbus RTU adapter module	02-01-03
EX-1100	EtherCAT adapter module	02-01-04
EX-1110	PROFINET adapter module	02-01-05
EX-1040	CC-link adapter module	02-01-06
EX-1050	CANopen adapter module	02-01-11
EX-1120	EtherNet/IP adapter	02-01-08
EX-1121	EtherNet/IP adapter	02-01-08-1
EX-1140	CC-Link IEFB bus adapter	02-01-09

- PROFINET Adapter indicator definition

Serial number	Indicator	instructions	Color	State	Meaning
1	SYS	System indicator	green	Blinking at 1Hz	Communication is normal
				Blinking at 5HZ	I/O lost from the station
				One flash one out	IO module station number assignment

					failed
				Two flashes one out	I/O module fails to be configured
				out	IO module is not running
2	UNIT PWR	System power indicator	green	on	System power supply is normal
				out	System power supply is not connected or faulty
3	IO PWR	IO power indicator	green	on	I/O power supply is normal
				out	I/O power supply is not connected or faulty
4	NET-RUN	Running indicator light	green	on	Communication is normal, data transmission is normal
				out	Communication stops, data transfer stops
5	NET-ERR	System failure indicator	red	on	The network is not connected
				flash	The network is connected, PN communication abnormal
				out	The network is connected, PN communication invalid
6	LINK/ACT1	Indicators of Network Port 1	orange	on	The network connection is normal
				out	Network not connected or abnormal
7	LINK/ACT2	Indicators of network Port 2	orange	on	The network connection is normal
				out	Network not connected or abnormal

● PROFINET adapter communication interface definition

Ethernet interface	Bit number	signal	Signal definition
	1	TX+	Positive end of data transmission

	2	TX-	Negative end of data transmission
	3	RX+	Positive data receiving end
	4	--	--
	5	--	--
	6	RX-	Data receiving negative end
	7	--	--
	8	--	--
	Connector housing	PE	Chassis ground

- PROFINET Adapter parameters

Technical parameters	
Bus protocol	PROFINET
Address set	According to the main
Expanding the number of I/OS	32
Maximum input/output bytes	Input: 340 Byte/Output: 340 Byte
The bus rate	100Mbps
Transmission distance	100m (station to station distance)
System side power input	DC24V (18 to 36)
The system side provides current	2 a (Max)
Power input of the I/O port	DC24V (+ / - 20%)
Output current of the I/O port	10 a (Max)
Power consumption	270mA

Conventional parameters	
System side electrical isolation	AC500V
Protection against reverse connection	support
Over current protection	This function is supported by the system, but not by the I/O
Over voltage protection	support
Wire specifications	0.2 ~ 1.5 mm squared
Connection mode	No screw
Overall dimensions	90 x 67 x 34 mm
The weight of the	240g
Protection grade	IP20
Temperature range	Operating temperature: -10 ~ 55°C, storage temperature: -20 ~ 85°C
Relative humidity	95% no condensation

2.1.6 CC-link adapter

- CC-link adapter model and order number

Model	Specifications description	The order no.
EX-1010	DeviceNet adapter module	02-01-01
EX-1130	Modbus TCP bus adapter	02-01-11
EX-1030	Modbus RTU adapter module	02-01-03
EX-1100	EtherCAT adapter module	02-01-04
EX-1110	PROFINET adapter module	02-01-05
EX-1040	CC-link adapter module	02-01-06
EX-1050	CANopen adapter module	02-01-11

EX-1120	EtherNet/IP adapter	02-01-08
EX-1121	EtherNet/IP adapter	02-01-08-1
EX-1140	CC-Link IEFB bus adapter	02-01-09

● CC-link Adapter indicator definition

Serial number	Indicator	Instructions	Color	State	Meaning
1	SYS	System indicator	green	Blinking at 1Hz	Communication is normal
				Blinking at 5HZ	I/O lost from the station
				One flash one out	IO module station number assignment failed
				Two flashes one out	I/O module fails to be configured
				out	IO module is not running
2	UNIT PWR	System power indicator	green	on	System power supply is normal
				out	System power supply is not connected or faulty
3	IO PWR	IO power indicator	green	on	I/O power supply is normal
				out	I/O power supply is not connected or faulty
4	NET-RUN	Running indicator light	green	on	Communication is normal, data transmission is normal
				out	Communication stops, data transfer stops
5	NET-ERR	System failure indicator	red	on	Cc-link communication error
				out	Cc-link communication is normal

6	NETTX	Data transmission indicator light	green	flash	Data transmission in progress
				out	Data is stopped or abnormal
7	NETRX	Data reception indicator light	green	flash	Data receiving
				out	Data is stopped or abnormal

● CC-link adapter communication interface definition

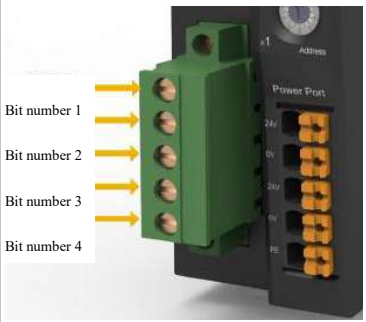
CC-link Communication interface	Bit number	signal	Signal definition
	1	DA	A communications line
	2	DB	Communication line B
	3	DG	Communication common end
	4	SLD	Shielding wire
	5	FG	Chassis ground

● Set the DIP switch for the CC-Link adapter

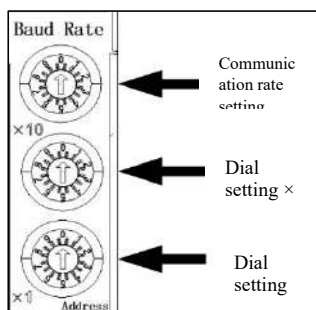

Cc-link Communication rate setting			
Dial the code number		Communication rate	Corresponding transmission distance
0	5	156kbps	1200m
1	6	625kbps	600m
2	7	2.5 Mbps	200m
3	8	5Mbps	150m

4	9	10Mbps	100m
---	---	--------	------

CC-link Dip switch corresponds to the station id						
Rate distance corresponding to dip station number	Fixed logic station	Dial the code: 0	Dial the code: 1	Dial the code: 2	Dial the code: 3	Dial the code: 4
	Variable logic station	Dial the code: 5	Dial the code: 6	Dial the code: 7	Dial the code: 8	Dial the code: 9
CC-link Communication rate and transmission distance		156kbps	625kbps	2.5 Mbps	5Mbps	10Mbps
		1200m	600m	200m	150m	100m
CC-link Indicates the number of all secondary site bits (I/O and registers)						
Number of remote I/O points		2048 DI / 2048 DO				
Remote register RW W		256 AO (Master station -> Remote, local station)				
Remote register RW r		256 point AI (primary -> Remote, local)				
Number of connection points per site						
Number of remote I/O points		32 DI points, 32 DO points				
Remote register RW W		4 AO (Master station -> Remote, local station)				
Remote register RW r		4 points AI (Primary -> Remote, local)				
CC-link Bus stations/points						
Max: 4		Max: 128 DI, 128 DO, 16 AI, 16 AO				
Maximum number of I/O modules that can be expanded by CC-Link bus		4 x (32DI+ 32DO +4AI+4AO)				

● CC-link adapter parameters

Technical parameters	
Bus protocol	CC-Link

Address set	1-64
Expanding the number of I/OS	32
Maximum input/output bytes	Input: 48 bytes /Output: 48 bytes
The bus rate	156 KBPS / 625 KBPS / 2.5 Mbps / 10 Mbps
Transmission distance	1200 m (Max)
System side power input	DC24V (18 to 36)
The system side provides current	2 a (Max)
Power input of the I/O port	DC24V (+ / - 20%)
Output current of the I/O port	10 a (Max)
Power consumption	205mA
Conventional parameters	
System side electrical isolation	AC500V
Protection against reverse connection	support
Over current protection	This function is supported by the system, but not by the I/O
Over voltage protection	support
Wire specifications	0.2 ~ 1.5 mm squared
Connection mode	No screw
Overall dimensions	90 x 67 x 34 mm
The weight of the	240g
Protection grade	IP20
Temperature range	Operating temperature: -10 ~ 55°C, storage temperature: -20 ~ 85°C

Relative humidity	95% no condensation
-------------------	---------------------

2.1.7 CANopen Adapter

- CANopen adapter model and order number

model	Specifications describe	The order no.
EX-1010	DeviceNet adapter module	02-01-01
EX-1130	Modbus TCP bus adapter	02-01-11
EX-1030	Modbus RTU adapter module	02-01-03
EX-1100	EtherCAT adapter module	02-01-04
EX-1110	PROFINET adapter module	02-01-05
EX-1040	Cc-link adapter module	02-01-06
EX-1050	CANopen adapter module	02-01-11
EX-1120	EtherNet/IP adapter	02-01-08
EX-1121	EtherNet/IP adapter	02-01-08-1
EX-1140	CC-Link IEFB bus adapter	02-01-09

- CANopen adapter parameters

Technical parameters	
Bus protocol	CANopen
Address set	0 ~ 99
Expanding the number of I/OS	32
Maximum input/output bytes	Input: 512 Byte/Output: 512 Byte
The bus rate	10 KBPS ~ 1 MBPS
Transmission distance	1000 m (Max)
System side power input	DC24V (18 to 36)

The system side provides current	2 a (Max)
Power input of the I/O port	DC24V (+ / - 20%)
Output current of the I/O port	10 a (Max)
System power current consumption	126mA
Conventional parameters	
System side electrical isolation	AC500V
Protection against reverse connection	support
Over current protection	This function is supported by the system, but not by the I/O
Over voltage protection	support
Wire specifications	0.2 ~ 1.5 mm squared
Connection mode	No screw
Overall dimensions	90 x 67 x 34 mm
The weight of the	240g
Protection grade	IP20
Temperature range	Operating temperature: -10 ~ 55°C, storage temperature: -20 ~ 85°C
Relative humidity	95% no condensation

2.1.8 EtherNet/IP Adapter (EX-1120)

- EtherNet/IP adapter model and order number

Model	Specifications description	The order no.
EX-1010	DeviceNet adapter module	02-01-01
EX-1130	Modbus TCP bus adapter	02-01-11

EX-1030	Modbus RTU adapter module	02-01-03
EX-1100	EtherCAT adapter module	02-01-04
EX-1110	PROFINET adapter module	02-01-05
EX-1040	Cc-link adapter module	02-01-06
EX-1050	CANopen adapter module	02-01-11
EX-1120	EtherNet/IP adapter module	02-01-08
EX-1121	EtherNet/IP adapter	02-01-08-1
EX-1140	CC-Link IEFB bus adapter	02-01-09

● EtherNet/IP adapter indicator definition

Serial number	Indicator	Instructions	Color	State	Meaning
1	SYS	System indicator	green	Blinking at 1HZ	Communication is normal
				Blinking at 5HZ	The I/O slave station lost or detected the factory restore button signal
				on	The factory Settings are restored
2	UNIT PWR	System power indicator	green	on	The system power supply is normal
				out	The system power supply is not connected or faulty
3	IO PWR	IO power indicator	green	on	The I/O power supply is normal
				out	The I/O power supply is not connected or faulty
4	MS	Module status indicator	—	Green light on	Device operation: Communication is normal
				Green light flash (1HZ)	Standby state: Module not configured
				Green red green	Self-test: power-on self-test status of the

				light flash (1HZ)	module
				Red light flash (1HZ)	Glitch: The device detects a recoverable glitch
				Red light on	Major fault: The device has detected a major fault error that cannot be recovered
				out	No power supply: No power supply
5	NS	Network status indicator	—	Green light on	Connection established: The IP address is configured and at least one CIP connection has been established. The master connection has not timed out.
				Green light flash (1 HZ)	Connection not established: The IP address is configured, the CIP connection is not established, and the master station connection has not timed out.
				Green red green light flash (1 HZ)	Self-test: power-on self-test status of the module
				Red light (1 HZ)	Connection timeout: The primary connection times out after the IP address is configured
				Red light on	Duplicate IP address: The IP address has been used
				out	No power, no IP address
6	LINK/ACT1	Indicators of Network Port 1	green	on	Network connection normal
				out	The network is disconnected or abnormal
7	LINK/ACT2	Indicators of network Port 2	green	on	Network connection normal
				out	The network is disconnected or abnormal

● EtherNet/IP adapter communication interface definition

Ethernet interface	Bit number	signal	Signal definition
--------------------	------------	--------	-------------------

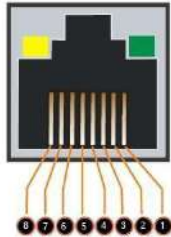
 <p>1:TX+ 2:TX- 3:RX+ 4:TERM 5:TERM 6:RX- 7:TERM 8:TERM</p>	1	TX+	Positive end of data transmission
	2	TX-	Negative end of data transmission
	3	RX+	Positive data receiving end
	4	--	--
	5	--	--
	6	RX-	Data receiving negative end
	7	--	--
	8	--	--
	Connector housing	PE	Chassis grounding

● EtherNet/IP DIP switch definition

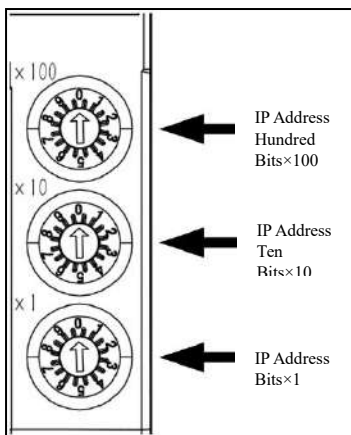

IP Address Setting	
X 100	IP address hundred bits
X 10	IP address ten bits
X 1	IP address bits

Note: The default network segment of ex-1120 is 192.168.0.x. Set the DIP switch to the IP address. For example, set the 100 toggle to 1, 10 toggle to 9, and 1 toggle to 5.

● EtherNet/IP adapter parameters

Technical parameters	
Bus protocol	EtherNet/IP
Address set	Dip switch Settings

Expanding the number of I/OS	32
Maximum input/output bytes	Input: 504 Byte/Output: 504 Byte
The bus rate	100Mbps
Transmission distance	100m (station to station distance)
System side power input	DC24V (18 to 36)
The system side provides current	2 a (Max)
Power input of the I/O port	DC24V (+ / - 20%)
Output current of the I/O port	10 a (Max)
Power consumption	413mA
Conventional parameters	
System side electrical isolation	AC500V
Protection against reverse connection	support
Over current protection	This function is supported by the system, but not by the I/O
Over voltage protection	support
Wire specifications	0.2 ~ 1.5 mm squared
Connection mode	No screw
Overall dimensions	90 x 67 x 34 mm
The weight of the	240g
Protection grade	IP20
Temperature range	Operating temperature: -10 ~ 55°C, storage temperature: -20 ~ 85°C
Relative humidity	95% no condensation

2.1.9 EtherNet/IP Adapter (EX-1121)

- EtherNet/IP adapter model and order number

Model	Specifications description	The order no.
EX-1010	DeviceNet adapter module	02-01-01
EX-1130	Modbus TCP bus adapter	02-01-11
EX-1030	Modbus RTU adapter module	02-01-03
EX-1100	EtherCAT adapter module	02-01-04
EX-1110	PROFINET adapter module	02-01-05
EX-1040	Cc-link adapter module	02-01-06
EX-1050	CANopen adapter module	02-01-11
EX-1120	EtherNet/IP adapter module	02-01-08
EX-1121	EtherNet/IP adapter	02-01-08-1
EX-1140	CC-Link IEFB bus adapter	02-01-09

- EtherNet/IP adapter indicator definition

Serial number	Indicator	Instructions	Color	State	Meaning
1	SYS	System indicator	green	Blinking at 1Hz	Communication is normal
				Blinking at 5HZ	The I/O slave station lost or detected the factory restore button signal
				on	The factory Settings are restored
2	UNIT PWR	System power indicator	green	on	The system power supply is normal
				out	The system power supply is not connected or faulty

3	IO PWR	IO power indicator	green	on	The I/O power supply is normal
				out	The I/O power supply is not connected or faulty
4	MS	Module status indicator	green	Green light on	Device operation: Communication is normal
				Green light flash (1HZ)	Standby state: Module not configured
				Green red green flash (1HZ)	Self-test: power-on self-test status of the module
				Red light flash (1HZ)	Glitch: The device detects a recoverable glitch
				Red light on	Major fault: The device has detected a major fault error that cannot be recovered
				out	No power supply: No power supply
5	NS	Network status indicator	green	Green light on	Connection established: The IP address is configured and at least one CIP connection has been established. The master connection has not timed out.
				Green light flash (1 HZ)	Connection not established: The IP address is configured, the CIP connection is not established, and the master station connection has not timed out.
				Green red green flash (1 HZ)	Self-test: power-on self-test status of the module
				Red light (1 HZ)	Connection timeout: The primary connection times out after the IP address is configured

				Red light on	Duplicate IP address: The IP address has been used
				out	No power, no IP address
6	LINK/ACT1	Indicators of Network Port 1	green	on	Network connection normal
				out	The network is disconnected or abnormal
7	LINK/ACT2	Indicators of network Port 2	green	on	Network connection normal
				out	The network is disconnected or abnormal

● EtherNet/IP adapter communication interface definition

Ethernet interface	A no.	signal	Signal definition
<p>1:TX+ 2:TX- 3:RX+ 4:TERM 5:TERM 6:RX- 7:TERM 8:TERM</p>	1	TX+	Positive end of data transmission
	2	TX-	Negative end of data transmission
	3	RX+	Positive data receiving end
	4	--	--
	5	--	--
	6	RX-	Data receiving negative end
	7	--	--
	8	--	--
	Connector housing	PE	Chassis grounding

● EtherNet/IP DIP switch definition

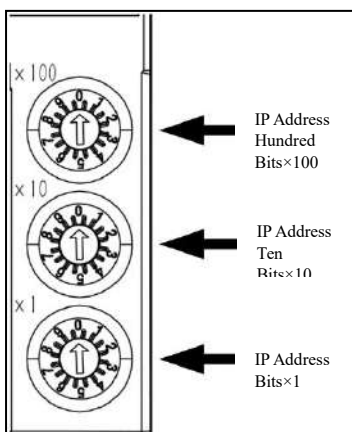

Dip switch definition	
Three combination dip set values	IP address setting method
0	Set through BOOTP.
001-254.	Set the low 1byte of the IP address by turning the switch.
More than 255	The module status indicator (MS) is blinking red because the settings are incorrect

Note:

- ① The IP address is assigned and the module works in BOOTP mode.
- ② The ex-1121 adds a button to restore factory Settings. Hold down the button for more than 2 seconds. When the SYS indicator changes from blinking to steady on, the factory Settings are restored.

● EtherNet/IP adapter parameters

Technical parameters	
Bus protocol	EtherNet/IP
Address set	Dip switch Settings
Expanding the number of I/OS	32
Maximum input/output bytes	Input: 504 Byte/Output: 504 Byte
The bus rate	100Mbps
Transmission distance	100m (station to station distance)
System side power input	DC24V (18 to 36)

The system side provides current	2 a (Max)
Power input of the I/O port	DC24V (+ / - 20%)
Output current of the I/O port	10 a (Max)
Power consumption	360mA
Conventional parameters	
System side electrical isolation	AC500V
Protection against reverse connection	support
Over current protection	This function is supported by the system, but not by the I/O
Over voltage protection	support
Wire specifications	0.2 ~ 1.5 mm squared
Connection mode	No screw
Overall dimensions	90 x 67 x 34 mm
The weight of the	240g
Protection grade	IP20
Temperature range	Operating temperature: -10 ~ 55°C, storage temperature: -20 ~ 85°C
Relative humidity	95% no condensation

2.1.10 CC-link IEFB Adapter

- CC-link IEFB adapter model and order number

Model	Specifications description	The order no.
EX-1010	DeviceNet adapter module	02-01-01

EX-1130	Modbus TCP bus adapter	02-01-11
EX-1030	Modbus RTU adapter module	02-01-03
EX-1100	EtherCAT adapter module	02-01-04
EX-1110	PROFINET adapter module	02-01-05
EX-1040	Cc-link adapter module	02-01-06
EX-1050	CANopen adapter module	02-01-11
EX-1120	EtherNet/IP adapter module	02-01-08
EX-1121	EtherNet/IP adapter	02-01-08-1
EX-1140	CC-Link IEFB bus adapter	02-01-09

● CC-link IEFB adapter indicator definition

serial number	indicator light	illustrate	color	state	meaning
1	SYS	System instructions lamp	red	destroy	Non-maintenance status
				Flashing (5Hz)	Flashing and recovery during upgrade transfer process Factory testing constants
				Flashing (1Hz)	System is running normally
			green	Flashing (5Hz)	The slave station is lost or the reset button is pressed Down
				Bright	Factory reset completed

				Two flashes and one out	Diagnostic configuration failed
	UNIT PWR	System power pointer indicator light	green	Bright	The system side power supply is normal
				destroy	The system side is not powered on or the power supply is abnormal.
	IO PWR	IO power indicator lamp	green	Bright	The IO side power supply is normal
				destroy	The IO side is not powered or the power supply is abnormal.
	NET-RUN	Running lights	green	Bright	The device is running normally
				destroy	There is an error in the module
	NET-ERR	System failure means indicator light	red	Bright	Module abnormality, such as duplication of slave stations, etc.
				destroy	Device is operating normally or is not receiving power
				Flashing (1Hz)	IP DIP switch is abnormal for you, DIP Value exceeds 254
2	LINK/ACT1			destroy	The network is not connected properly

	LINK/ACT2	Ethernet port	orange color	Bright	Network connection is OK, but no data interaction
				flashing	The network connection is normal and data is transferred mutually beneficial

serial number	IP address dialing instructions	symbol	Function
		×100	Hundreds digit of IP address (valid range 0~2)
		×10	Ten digits of IP address (valid range 0~9)
		×1	IP address single digit dialing (valid range 0~9)
4	power port		IO module input power supply (2L+, 2M) Adapter input power (1L+, 1M)

- CC-1ink IEFB adapter parameters

Basic parameters

Dimensions	90mm×67mm×14mm	
Operating temperature	0~55°C	
storage temperature	- 20~85°C	
Relative humidity	95% non-condensation	
Protection level	IP20	
Wiring specifications	0.2~1.5mm ²	
Wiring	No screws	
Power parameters		
System side power input	DC24V (18~36V)	
System side provides current	2A (Max)	
IO port side power input	DC24V (±20%)	
IO port side output current	10A(Max)	
System test electrical isolation	AC500V	
Anti-reverse connection protection	support	
Overvoltage protection	support	
Overcurrent protection	The system test supports it, but the IO side does not support it.	
Software parameters		
bus protocol	CC-Link IE Field Basic	
Communication rate	100Mbps	
Transmission distance	500m (distance between stations)	
	RX	64 points (occupies 1 station)

Maximum number of link points		128 points (occupies 2 stations) 192 points (occupies 3 stations) 256 points (occupies 4 stations)
	RY	64 points (occupies 1 station) 128 points (occupies 2 stations) 192 points (occupies 3 stations) 256 points (occupies 4 stations)
	RW	32 points (occupies 1 station) 64 points (occupies 2 stations) 96 points (occupies 3 stations) 128 points (occupies 4 stations)
	wx	32 points (occupies 1 station) 64 points (occupies 2 stations)
		96 points (occupies 3 stations) 128 points (occupies 4 stations)

2.2 Digital module

Digital module is divided into input and output two modules, according to the signal type is divided into transistor and relay, transistor can be divided into NPN and PNP two kinds, according to the point can be divided into 8, 16, 32 input/output points.

2.2.1 Digital input module

Digital input module includes PNP and NPN two signal types and 8 point, 16 point, 32 point three input specifications, users can choose the appropriate model according to the actual demand. The input effective level is divided into high level signal (PNP) and low level signal (NPN).

- Product Model Information

Model	Specifications description	The order no.
EX-2008	8 digital input, input signal is low level NPN	02-02-01
EX-2108	8 digital input, input signal is high level PNP	02-02-02
EX-200H	16 digital input, input signal is low level NPN	02-02-03
EX-210H	16 digital input, input signal is high level PNP	02-02-04

EX-213S	32 digital input, input signal PNP	02-02-18
EX-203S	32 digital input, input signal NPN	02-02-17
EX-2018	8 digital input, input signal is low level NPN, support 2/3 Wire sensor	02-02-06
EX-2118	8 digital input, input signal is low level PNP, support 2/3 Wire sensor	02-02-07
EX-202H	16	02-02-08
EX-212H		02-02-09

● Module indicator

Channel indicator Color	State	definition
green	Normally on	The module has signal input
	Out	The module has no signal input

● Module Parameters

Technical parameters								
model	EX-2008	EX-2108	EX-200H	EX-210H	EX-213S	EX-203S	EX-2018	EX-2118
The product name	Digital quantity input module							
Signal types	NPN	PNP	NPN	PNP	PNP	NPN	NPN	PNP
Power consumption	24mA	24mA	25mA	25mA	14mA	13mA	17mA	12mA
The input features								
Input channel number	8		16		32		8	
Input rated voltage	0V	24V	0V	24V	24V	0V	0V	24V
Time to shake	The value ranges from 1 to 10ms. Default value: 3ms							
Isolation of pressure	AC500V							

Isolation method		Optical coupling isolation
Physical parameters		
The dimensions		90 mm x 67 mm x 14 mm
Working temperature		0 ~ 55 °C
Storage temperature		- 20 ~ 85 °C
Relative humidity		95% no condensation
Protection grade		IP20

2.2.2 Digital output module

The output signal of the digital quantity output module is divided into transistor and relay. The effective level of the output of the transistor type is divided into high level signal (PNP) and low level signal (NPN). Digital output module has 8 point, 16 point, 32 point three types of specifications to choose from.

- Product Model Information

Model	Specifications description	The order no.
EX-3008	8-channel digital output, low level (NPN)	02-03-01
EX-3108	8 channels digital output, high level (PNP)	02-03-02
EX-300H	16 channels digital output, output signal is low level (NPN)	02-03-03
EX-310H	16 channels digital output, output signal is high level (PNP)	02-03-04
EX-3208	8-way relay output, output signal is relay (normally open)	02-03-05
EX-303S	32 channels digital output, output signal is low level (NPN)	02-03-18
EX-313S	32 channels digital output, output signal is high level (PNP)	02-03-19

- Module indicator

Channel indicator Color	state	define
green	Normally on	The module has signal output
	Out	The module has no signal output

● Module Parameters

Technical parameters							
model	EX-3008	EX-3108	EX-300H	EX-310H	EX-3208	EX-303S	EX-313S
The product name	Digital output module						
Signal types	NPN	PNP	NPN	PNP	relay	NPN	PNP
Current consumption	50mA	50mA	72mA	72mA	45mA	18mA	19mA
Output characteristic							
Output channel number	8	8	16	16	8	32	32
Power consumption	0V	24V	0V	24V	-	0V	24V
The drive ability	Single channel load 500mA, each continuous 8 channels maximum total current 2A				0.5 A, 2 A, DC30V/A C125V	Single channel load 500mA, each continuous 8 channels maximum total current 2A	
The load type	Resistive load, inductive load, lamp load						
Over current protection	support						
Overheating protection	support						
Isolation of pressure	AC500V						
Isolation method	Optical coupling isolation						
Physical parameters							
The dimensions	90 mm x 67 mm x 14 mm						

Working temperature	0 ~ 55 °C
Storage temperature	- 20 ~ + 85 °C
Relative humidity	95% no condensation
Protection grade	IP20

2.3 Analog module

Analog module is divided into input and output modules, voltage type and current type according to signal type, 12-bit and 16-bit according to resolution, and 4-channel and 8-channel according to channel.

2.3.1 Analog input module

Analog input module is divided into voltage type and current type. Voltage input module has 4 ranges to choose from, respectively 0 ~ 10V, ±10V, 0 ~ 5V, ±5V; Current input module is 4 ~ 20mA, 0 ~ 20mA, analog input module resolution is 12bit (accuracy 0.1%) and 16bit (accuracy 0.02%).

- Product Model Information

Model	Specifications description	The order no.
EX-4014	4 channel voltage input, resolution 12bit, accuracy 0.1%, The range is 0 ~ 10V	02-04-01
	4 channel voltage input, resolution 12bit, accuracy 0.1%, The range is 0 ~ 5V	02-04-02
EX-4114	4 channel voltage input, resolution 12bit, accuracy 0.1%, Range ±10V	02-04-03
	4 channel voltage input, resolution 12bit, accuracy 0.1%, Measuring range ±5V	02-04-04
EX-4054	4 channel voltage input, resolution 16bit, accuracy 0.02%, Range 0-10V	02-04-05
	4 channel voltage input, resolution 16bit, accuracy 0.02%, Range 0-5V	02-04-06
EX-4154	4 channel voltage input, resolution 16bit, accuracy 0.02%,	02-04-07

	Range $\pm 10V$	
	4 channel voltage input, resolution 16bit, accuracy 0.02%, Measuring range $\pm 5V$	02-04-08
EX-4414	4 channel current input, resolution 12bit, accuracy 0.1%, The range is 4 ~ 20mA	02-04-09
	4 channel current input, resolution 12bit, accuracy 0.1%, The range is 0 ~ 20mA	02-04-10
EX-4454	4 channel current input, resolution 16bit, accuracy 0.02%, The range is 4 ~ 20mA	02-04-11
	4 channel current input, resolution 16bit, accuracy 0.02%, The range is 0 ~ 20mA	02-04-12
EX-4018	8 channel voltage input, resolution 12bit, accuracy 0.1%, The range is 0 ~ 10V	02-04-29
	8 channel voltage input, resolution 12bit, accuracy 0.1%, The range is 0 ~ 5V	02-04-30
EX-4118	8 channel voltage input, resolution 12bit, accuracy 0.1%, Range $\pm 10V$	02-04-31
	8 channel voltage input, resolution 12bit, accuracy 0.1%, Measuring range $\pm 5V$	02-04-32
EX-4418	8 channel current input, resolution 12bit, accuracy 0.1%, The range is 4 ~ 20mA	02-04-33
	8 channel current input, resolution 12bit, accuracy 0.1%, The range is 0 ~ 20mA	02-04-34

● Module indicator

Channel indicator Color	state	Definition
green	Flash	There is analog signal input

	Normally on	Analog input is out of range
	Out	No analog signal input

The following table is the corresponding numerical table of analog input range. The blue line in the broken line diagram is voltage type, and the orange line is current type

- Analog quantity range corresponds to the value

Input type			
Resolution	Polarity	0-10V, 0-5V	4~20mA
		±10V, ±5V	0~20mA
12 bit	Unipolar	0~4095	0~4095
	Bipolar	-2048~+2047	-
16 bit		0~65535	0~65535
	bipolar	-32768~+32767	-

- Analog voltage input module digital - analog curve

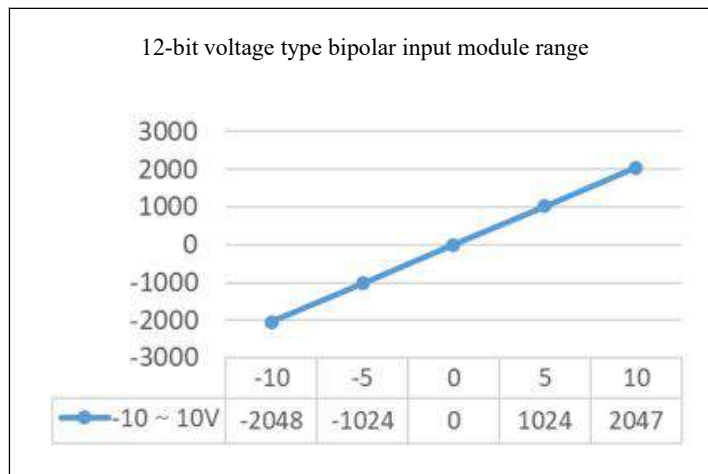
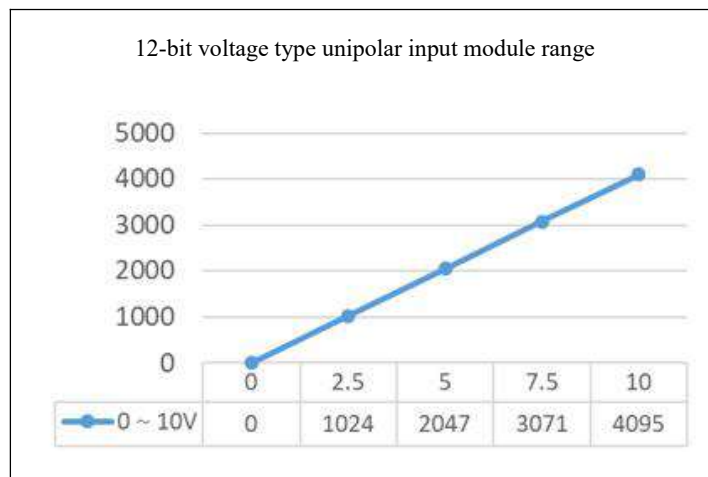

- Analog current mode input module digital - analog curve

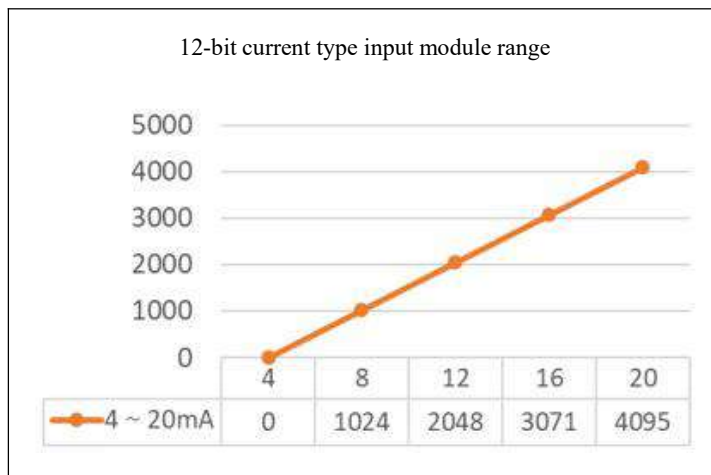

- 12-bit 4-20mA analogical conversion formula (X is current value, Y is the corresponding value of current value) :

$$\frac{X - 4}{20 - 4} = \frac{Y}{4095}$$

- 12-bit 0-20mA analogical conversion formula (X is the current value, Y is the corresponding value of the current value) :

$$\frac{X}{20} = \frac{Y}{4095}$$

- 12-bit 0-10V digital-analog conversion formula (X is the voltage value, Y is the corresponding value of the current voltage value) :

$$\frac{X}{10} = \frac{Y}{4095}$$

- 16-bit 0-10V digital-analog conversion formula (X is the voltage value, Y is the corresponding value of the current voltage value) :

$$\frac{X}{10} = \frac{Y}{65535}$$

- Module Parameters

Technical parameters									
model	EX-4014	EX-4018	EX-4114	EX-418	EX-4054	EX-4154	EX-4414	EX-4454	EX-4418
The product	Analog input module								

name									
Signal types	0 to 10V,0 to 5V		Plus or minus 10 v, + 5 v		0 ~ 10 v 0 ~ 5 v		Plus or minus 10 v + 5 v		4 ~ 20mA,0 ~ 20mA
Power consumption	82mA	82mA	82mA	182mA	82mA	82mA	53mA	182mA	182mA
The input features									
Output channel number	4	8	4	8	4	4	4	4	8
The input filter	Configurable: level 0 to 3 (default 1)								
The input impedance	> 500 k Ω						100 Ω		
The resolution of the	12				16		12	16	12
precision	0.1%				0.02%		0.1%	0.02%	0.1%
Over voltage protection	support								
Isolation of pressure	AC500V on the field side and digital side, channels are not isolated								
Physical parameters									
The dimensions	90 mm x 67 mm x 14 mm								
Working temperature	0 ~ 55 $^{\circ}\text{C}$								
Protection grade	IP20								

2.3.2 Analog output module

Analog output module is divided into voltage type and current type. Voltage input module has 4 ranges to choose from, respectively 0 ~ 10, $\pm 10\text{V}$, 0 ~ 5V, $\pm 5\text{V}$; Current input module is divided into 4 ~ 20mA, 0 ~ 20mA. Analog output module resolution is 12bit (accuracy 0.1%) and 16bit (accuracy 0.02%).

- Product Model Information

model	Specifications description	The order no.
-------	----------------------------	---------------

EX-5014	4 channel voltage output, resolution 12bit, accuracy 0.1%, The range is 0 ~ 10V	02-05-01
	4 channel voltage output, resolution 12bit, accuracy 0.1%, The range is 0 ~ 5V	02-05-02
EX-5114	4 channel voltage output, resolution 12bit, accuracy 0.1%, Range $\pm 10V$	02-05-03
	4 channel voltage output, resolution 12bit, accuracy 0.1%, measuring range $\pm 5V$	02-05-04
EX-5054	4 channel voltage output, resolution 16bit, accuracy 0.02%, The range is 0 ~ 10V	02-05-05
	4 channel voltage output, resolution 16bit, accuracy 0.02%, The range is 0 ~ 5V	02-05-06
EX-5154	4 channel voltage output, resolution 16bit, accuracy 0.02%, Range $\pm 10V$	02-05-07
	4 channel voltage output, resolution 16bit, accuracy 0.02%, Measuring range $\pm 5V$	02-05-08
EX-5414	4 channel current output, resolution 12bit, accuracy 0.1%, The range is 4 ~ 20mA	02-05-09
	4 channel current output, resolution 12bit, accuracy 0.1%, The range is 0 ~ 20mA	02-05-10
EX-5454	4 channel current output, resolution 16bit, accuracy 0.02%, The range is 4 ~ 20mA	02-05-11
	4 channel current output, resolution 16bit, accuracy 0.02%, The range is 0 ~ 20mA	02-05-12
EX-5018	8 channel voltage output, resolution 12bit, accuracy 0.1%, The range is 0 ~ 10V	02-05-13
	8 channel voltage output, resolution 12bit, accuracy 0.1%,	02-05-14

	The range is 0 ~ 5V	
EX-5118	8 channel voltage output, resolution 12bit, accuracy 0.1%, Range ±10V	02-05-15
	8 channel voltage output, resolution 12bit, accuracy 0.1%, Measuring range ±5V	02-05-16
EX-5418	8 channel current output, resolution 12bit, accuracy 0.1%, The range is 4 ~ 20mA	02-05-17
	8 channel current output, resolution 12bit, accuracy 0.1%, The range is 0 ~ 20mA	02-05-18

● Module indicator

Channel indicator Color	State	definition
green	Flash	There is analog signal output
	Normally on	Program channel value out of range
	Out	No analog signal output

The following table is the corresponding numerical table of analog input range. The blue line in the broken line diagram is voltage type, and the orange line is current type

● Analog quantity range corresponds to the value

Input type		Simulated Quantity Input Value	
		Voltage-mode	Current-mode
Resolution	Polarity	0-10V, 0-5V ±10V, ±5V	4~20mA 0~20mA
	12 bit	Unipolar	0~4095
	bipolar	-2048~+2047	-
16 bit	Unipolar	0~65535	0~65535
	bipolar	-32768~+32767	-

● Analog voltage output module modulus curve

12-bit voltage type unipolar input module range

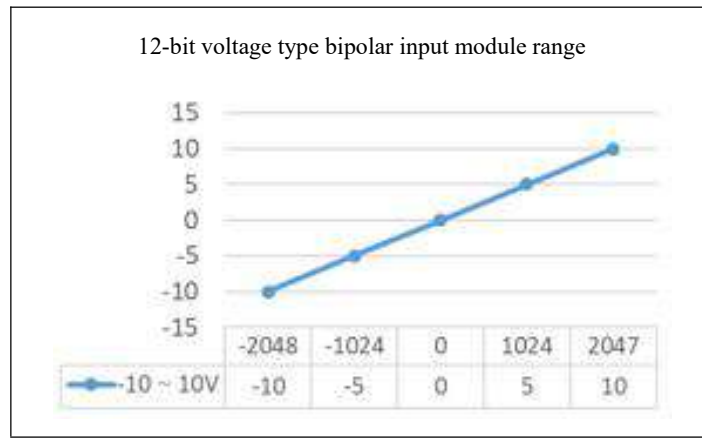
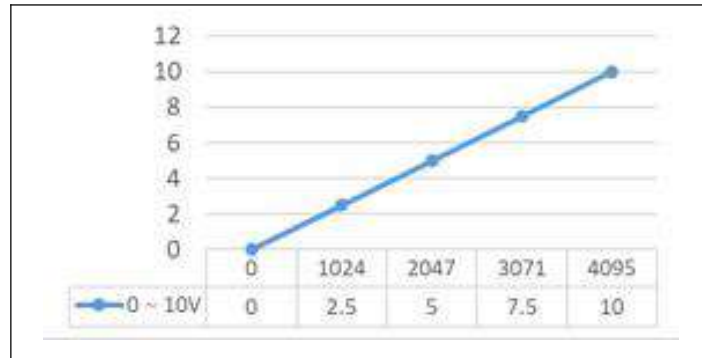

- Analog voltage output module modulus curve

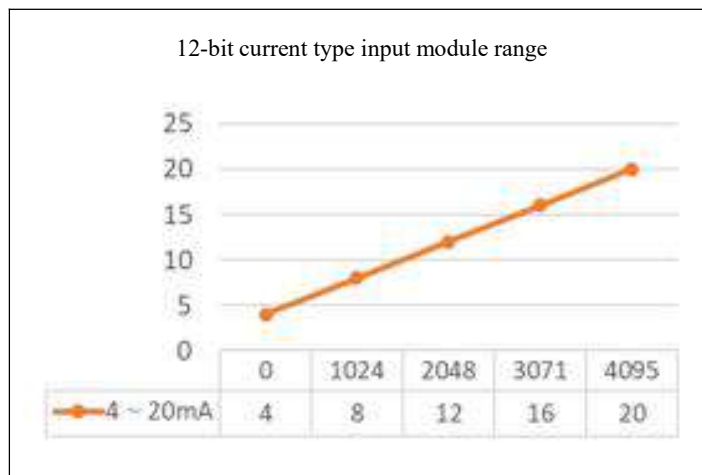

- 12-digit 4-20mA modulus conversion formula (X is the current value, Y is the corresponding value of the current value) :

$$\frac{X - 4}{20 - 4} = \frac{Y}{4095}$$

- 12-bit 0-20mA modulus conversion formula (X is the current value, Y is the corresponding value of the current value) :

$$\frac{X}{20} = \frac{Y}{4095}$$

- 12-bit 0-10V modulus conversion formula (X is the voltage value, Y is the corresponding value of the current voltage value) :

$$\frac{X}{10} = \frac{Y}{4095}$$

- 16-bit 0-10V modulus conversion formula (X is the voltage value, Y is the corresponding value of the current voltage value) :

$$\frac{X}{10} = \frac{Y}{65535}$$

- Module Parameters

Technical parameters									
model	EX-5014	EX-5018	EX-5114	EX-5118	EX-5054	EX-5154	EX-5414	EX-5454	EX-5418
The product name	Analog output module								
Signal types	0 to 10V,0 to 5V		Plus or minus 10 v, + 5 v		0 ~ 10 v 0 ~ 5 v	Plus or minus 10 v + 5 v	4 ~ 20mA,0 ~ 20mA		
Power consumption	24mA	21mA	24mA	21mA	24mA	24mA	21mA	21mA	21mA
The input features									
Output channel number	4	8	4	8	4	4	4	4	8
The output load	> 10 k Ω						< 500 Ω		
The load type	Impedance load								
The resolution of the	12				16		12	16	12
precision	0.1%				0.02%		0.1%	0.02%	0.1%

Over voltage protection	support
Isolation of pressure	AC500V on the field side and digital side, channels are not isolated
Physical parameters	
The dimensions	90 mm x 67 mm x 14 mm
Working temperature	0 ~ 55 °C
Protection grade	IP20

2.4 Temperature Collection module

The temperature collection module is divided into thermocouple (TC) and thermal resistance (RTD) according to the sensor type.

2.4.1 Thermocouple module

The filter of each channel of the thermocouple temperature collection module can be configured separately (default is 10). The thermocouple temperature collection module can support 10 types of thermocouple sensors, which are K, J, T, E, N, S, R, B, C, and MV.

- Product Model Information

model	Specifications description	The order no.
EX-46 54	4 channel K thermocouple acquisition module, Range of -100 ~ 1370°C	02-04-13
	4 channel J thermocouple acquisition module, Range -100 ~ 1200°C	02-04-14
	4 channel T thermocouple acquisition module, Range -100 ~ 400°C	02-04-15
	4 channel TYPE E thermocouple acquisition module, Range -100 ~ 1000°C	02-04-16

	4-channel N-type thermocouple acquisition module, Range -100 ~ 1300°C	02-04-17
	4-channel S-type thermocouple acquisition module, Range 0 ~ 1700°C	02-04-18
	4 channel R thermocouple acquisition module, Range 0 ~ 1700°C	02-04-19
	4 channel B thermocouple acquisition module, The range is 600 ~ 1800°C	02-04-20
	4 channel C thermocouple acquisition module, Range 0 ~ 2320°C	02-04-21
	4 channel MV voltage signal acquisition module, Range -100mv to 100mv	02-04-22

- Module indicator

Channel indicator Color	state	definition
green	Flash	Thermocouple sensor has signal input
	Normally on	Thermocouple sensor signal out of range
	Out	No thermocouple sensor signal input

- Table of values corresponding to temperature values measured in EX-4654

EX-4654				
Type	Temperature(°C)	Numerical (decimal)	Bolt value	Note
K	-100~+1370	-1000~+13700	32767	The code value obtained by PLC is divided by 10 to obtain the actual temperature value
J	-100~+1200	-1000~+12000	32767	
T	-100~+400	-1000~+4000	32767	

E	-100 ~ +1000	-1000 ~ +10000	32767	
N	-100 ~ +1300	-1000 ~ +13000	32767	
S	0 ~ +1700	0 ~ +17000	32767	
R	0 ~ +1700	0 ~ +17000	32767	
B	600 ~ +1800	6000 ~ +18000	32767	
C	0 ~ +2320	0 ~ +23200	32767	
mv	-100 ~ +100mv	-30000 ~ 30000	32767	The actual -100 mv to +100 mV is mapped to the range of -30000 to 30000

● Module Parameters

Technical parameters	
model	EX-4654
Product name	Thermocouple module
Power consumption	41mA
The input features	
Input channel number	4
The input filter	The value ranges from 0 to 40. Default value: 10
The connection method	2 wire system
Signal types	K, J, T, E, N, S R, B, C, mV
Temperature range	Default: TYPE K: -100...+ 1370 °C
The resolution of the	0.1 °C / digital
precision	0.5% (full scale)

Over voltage protection	support
Isolation of pressure	AC500V on the field side and digital side, channels are not isolated
Diagnosis and Alarm	
Disconnect the alarm	Supported (When the channel code value is 32767, the channel is disconnected)
Physical parameters	
The dimensions	90 mm x 67 mm x 14 mm
Working temperature	0 ~ 55 °C
Storage temperature	- 20 ~ + 85 °C
Relative humidity	95% no condensation
Protection grade	IP20

2.4.2 Thermal Resistance Module

The filter of each channel of the thermal resistance temperature acquisition module can be configured separately (the default is 10). The thermal resistance temperature acquisition module can support six types of thermal resistance sensors, namely PT100, PT200, PT500, PT1000, Ni120, and resistance measurement.

- Product Model Information

model	Specifications describe	The order no.
EX-47 54	4 channel PT100 thermal resistance acquisition module, Range -200 ~ 800°C	02-04-23
	4 channel PT200 thermal resistance acquisition module, Range of -200 ~ 630°C	02-04-24
	4 channel PT500 thermal resistance acquisition	02-04-25

	module, Range of -200 ~ 630°C	
	4 channel PT1000 thermal resistance acquisition module, Range -50 ~ 300°C	02-04-26
	4 channel Ni120 thermal resistance acquisition module, Range -79 ~ 309°C	02-04-27
	4-channel resistance value acquisition module, The range is 0 ~ 400 ω	02-05-28

● Module indicator

Channel indicator Color	state	definition
green	flashing	The thermal resistance sensor has signal input
	Normally on	Signal of thermal resistance sensor is out of range
	destroy	No thermal resistance sensor signal input

● Table of values corresponding to temperature values measured in EX-4754

EX-4754				
Type	Temperature(°C)	Numerical value (decimal)	Bolt value	Note
PT100	-200 ~ +800	-2000 ~ +8000	32767	The code value obtained by PLC is divided by 10 to obtain the actual temperature value
PT200	-200 ~ +630	-2000 ~ +6300	32767	
PT1000	-50 ~ +300	-500 ~ +3000	32767	
NI120	-79 ~ +309	-790 ~ +3090	32767	
Resistance measurement	0 ~ 2000Q	0 ~ 30000	32767	Map the actual 0~2000 equal scale to the range 0~30000

- Module Parameters

Technical parameters	
model	EX-4754
The product name	Thermal resistance module
Power consumption	38mA
The input features	
Input channel number	4
The input filter	The value ranges from 0 to 40. Default value: 10
The connection method	2-wire or 3-wire (default 3-wire)
Signal types	PT100/PT200/PT500/PT1000/Ni20
Temperature range	- 200...+800 degrees (PT sensor), -79...+309 degrees (Ni sensor)
The resolution of the	0.1 °C / digital
precision	+ / - 1 °C
Over voltage protection	support
Isolation of pressure	AC500V on the field side and digital side, channels are not isolated
Diagnosis and Alarm	
Disconnect the alarm	Supported (When the channel code value is 32767, the channel is disconnected)
Physical parameters	
The dimensions	90 mm x 67 mm x 14 mm
Working temperature	0 ~ 55 °C
Storage	- 20 ~ + 85 °C

temperature	
Relative humidity	95% no condensation
Protection grade	IP20

2.5 Function Modules

Function module is divided into encoder module and high-speed pulse output module, according to the input/output signal type into NPN, PNP, differential.

2.5.1 Encoder Module

The encoder module can be divided into NPN, PNP and differential according to the input signal type, supporting encoder 1, 2 and 4 multiplier.

- Product Model Information

model	Specifications description	The order no.
EX-60 01	1 channel NPN, maximum input frequency 1MHz,	02-06-01
EX-60 11	1 channel PNP, maximum input frequency 1MHz,	02-06-02
EX-60 21	1 channel differential, maximum input frequency 1MHz,	02-06-03

- Module Parameters

Technical parameters			
model	EX-60 01	EX-6011	EX-6021
The product name	Encoder module		
Power consumption	38mA	38mA	75mA
The input features			
Input channel number	1 channel		
Input signal type	NPN	PNP	The differential

Counting mode	Linear, ring counter form		
Count range	0 to 4294967295 or -2147483648 to 2147483648		
Counting function selection	Count disable, latch counter, sampling counter, cycle pulse counter Frequency, rotation speed, period measurement		
Maximum input frequency	1MHz		
Orthogonal encoder multiplier	×1, ×2, ×4		
The input impedance	> 5 k Ω		
Electrical isolation	Optical coupling isolation		
Maximum connection distance of signal cables	2m	2m	10m
Physical parameters			
The dimensions	90 mm x 67 mm x 14 mm		
Working temperature	0 ~ 55 °C		
Protection grade	IP20		

2.6 Communication Module

Communication modules are classified into RS485 communication modules, RS232 and RS485 communication modules.

2.6.1 Communication module

- Product Model Information

model	Specifications description	The order no.
EX-63 01	RS485 free port communication module, supporting master/slave mode (default master station)	02-06-10
EX-63	RS232 Free port communication module, supporting	02-06-11

11	master/slave mode (default master station)	
EX-63 21	Modbus RTU Master communication module	02-06-14

● Module parameters

Technical parameters			
model	EX-6301	EX-6311	EX-6321
The product name	RS485 communication module	RS232 communication module	Modbus RTU Master
Current consumption	195mA		
The input features			
Input channel	1		
Baud rate	Optional: 1200, 2400, 4800, 9600 (default), 19200, 38400, 57600, 115200kbps		
Data bits	5, 6, 7, 8 bits (default)	eight	
Check digit	None (default), Odd, Even		
Stop bit	1 (default), 2 stop bits		
Automatic timing sending function	Time interval optional: 50ms, 100ms, 200ms, 400ms, 500ms, 600ms, 800ms, 1S (default), 1.5s, 2S, 3S, 4S, 5s, 6s, 8 s, 10 s	Does not support	
A master-slave mode	Yes, default master mode	Only the primary site is supported	
Response timeout			After the primary site sends a command, it waits for the response time of the secondary site. The value ranges from 1 to 65535 (1000 ms by default)
Character space			Frame character interval detection time (the time for transmitting

		a single character, depending on baud rate) (default: 5 characters)
Physical parameters		
The dimensions	90 mm x 67 mm x 14 mm	
Working temperature	0-55 °C	
Storage temperature	- 20 ~ + 85 °C	
Relative humidity	95% no condensation	
Protection grade	IP20	

2.7 Auxiliary Modules

Auxiliary modules are divided into power module and terminal module. A of psus, which respectively provide extra load for I/O modules, You can configure the psus as required under specific conditions.

2.7.1 Power Module and Terminal Module

- Product Model Information

model	Specifications description	The order no.
EX-TER01	Terminal module	02-00-00
EX-0100	System power I/O and power module, side power supply voltage DC24V to voltage DC5V±5%, maximum output load 2A, used for adapter and IO module processor power supply, which can provide IO power for 10A.	02-00-01

- Module Parameters

Technical parameters	
model	EX-0100
The product name	System power supply and I/O power module
Power supply features	

System side power supply voltage	DC24V (18 to 36 v)
Output system voltage	5 v (+ / - 5%)
Output system current	2 a (Max) DC24V (18 to 36 v) 10 a (Max)
Power supply voltage of the I/O side	
Load current on the I/O side	
Over voltage protection	support
Protection against reverse connection	support
Physical parameters	
The dimensions	90 mm x 67 mm x 14 mm
Working temperature	0-55 °C
Storage temperature	- 20 ~ + 85 °C
Relative humidity	95% no condensation
Protection grade	IP20

3 Module Installation

3.1 Basic Knowledge

All EX system modules are open equipment, which means that EX system I/O modules can only be installed in the connection, control cabinet or electrical operating room, and dry environment (protection class IP20). Provide safety protection in cabinets, control cabinets or operating rooms to prevent electric shock and the spread of fire.

EX series I/O modules can be installed on mounting rails that comply with EN 60715 (35 x 7.5 mm or 35 x 15 mm). In the control cabinet, the installation guide rail needs to be separately

grounded. Exception: If the guide rail is mounted on a grounded galvanized mounting plate, it is not necessary to ground the guide separately.

3.2 Installation Clearance

When installing or removing an EX distributed I/O system, keep a minimum clearance, as shown in Figure 3-1.

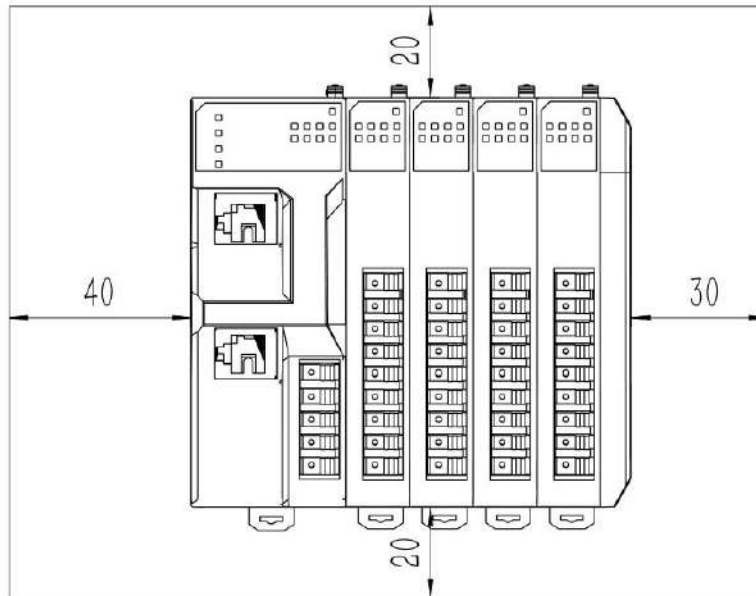

Figure 3-1 Minimum installation clearance

3.3 INSTALLING I/O Modules

3.3.1 Installing the Entire Module Group

Secure the installed modules to the guide rails, as shown in Figure 3-2.

- ① Loosen guide rail buckles on all modules.
- ② The module is hooked on the installation guide rail.
- ③ The module is fixed on the guide rail.
- ④ Module guide rail latch is locked.



Figure 3-2 Installing an entire module group

3.3.2 Adding an I/O Module

Figure 3-3 shows the sequence of adding an I/O module to the INSTALLED I/O system.

- ① Loosen the buckle of the module guide rail.
- ② Hook the module on the mounting guide rail.
- ③ The module is fixed on the guide rail.
- ④ Shift the module to the left from the guide rail.
- ⑤ Latch the module guide rail.

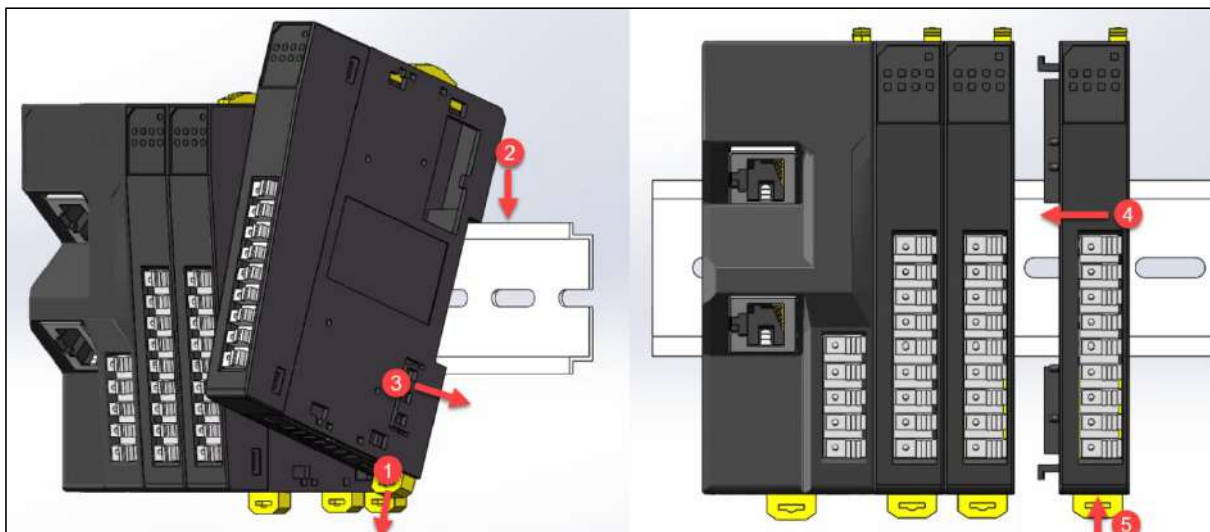

Figure 3-3 Adding an I/O module

3.4 Wiring standards and connecting standards

The diameter of the cable to be connected is 0.2-1.5, and the stripping length is 9-10mm. It is recommended to use a tubular cord end terminal.

Figure 3-4 shows the system line standard.

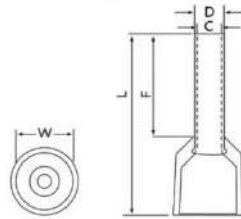

Figure 3-4 wiring standards

W terminal diameter	L/F Length of the terminal	D tube diameter	Gb/mm squared	Stripping length /mm
2.8 3.0 (2.8)	16.4/10	1.3 1.5 (1.3)	0.75 1.5 (0.75)	10 mm +/- 4

The proposed dimensions are in front of the brackets, and the standard dimensions are in the brackets. The dimensions of W, F and D are in mm

Use standard crimping pliers to crimp cables, as shown in Figure 3-5



Figure 3-5 Cable crimping mode

4 Module size diagram and wiring diagram

4.1 Module size diagram

Module dimensions can be classified into adapter, IO module, and terminal module dimensions.

4.1.1 Adapter size diagram

Figure 4-1 shows the dimensions (length, width, height) of all adapter modules in the EX series.

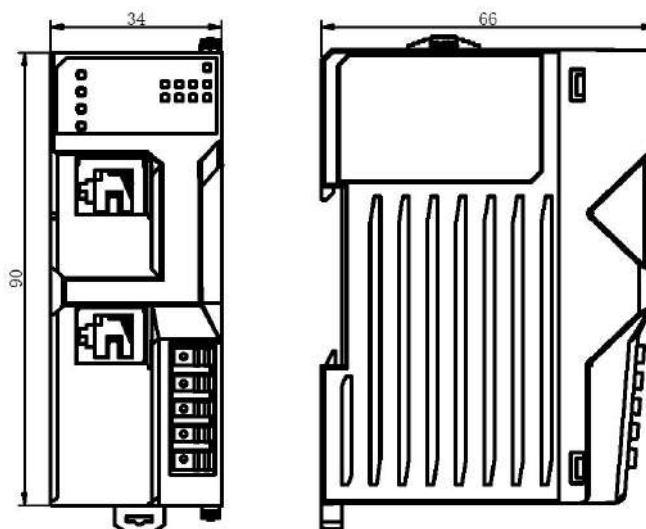

Figure 4-1 Dimensions of the adapter module

4.1.2 I/O Module Dimensions diagram

Figure 4-2 shows the dimensions of the 32-channel I/O module. Figure 4-3 shows the dimensions of the other I/O modules.

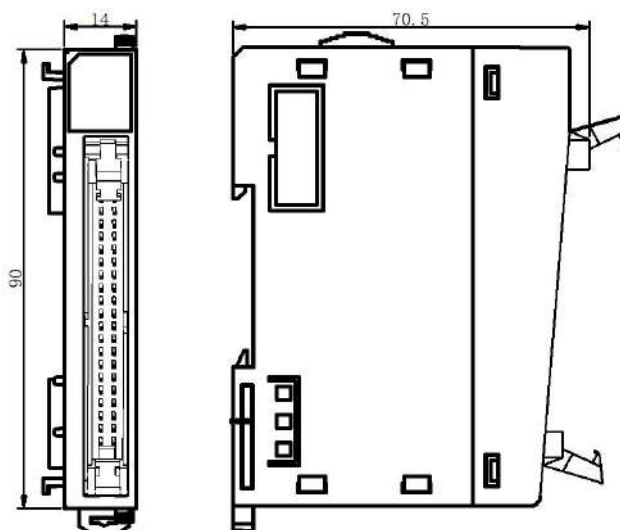

Figure 4-2 Dimensions of the digital 32 channel INPUT/output module

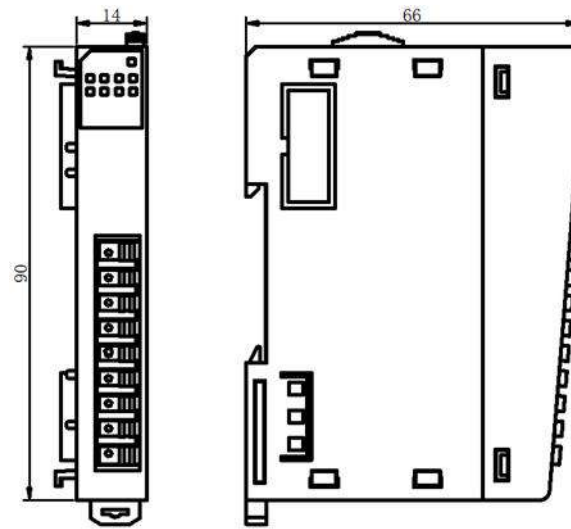

Figure 4-3 DIMENSIONS of the I/O module

4.1.3 Terminal module size diagram

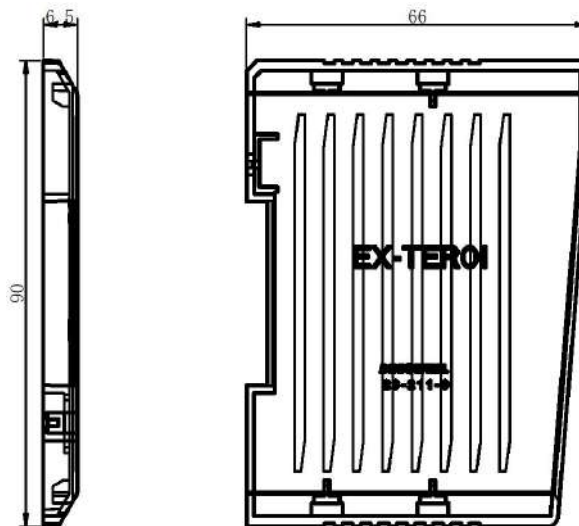

Figure 4-4 Dimensions of a terminal module

4.2 Module Wiring diagram

4.2.1 Adapter wiring diagram

All adapters in the EX series are connected to the same cable. The cable connections to the adapter are divided into system power and I/O power. Figure 4-5 shows the cable connections.

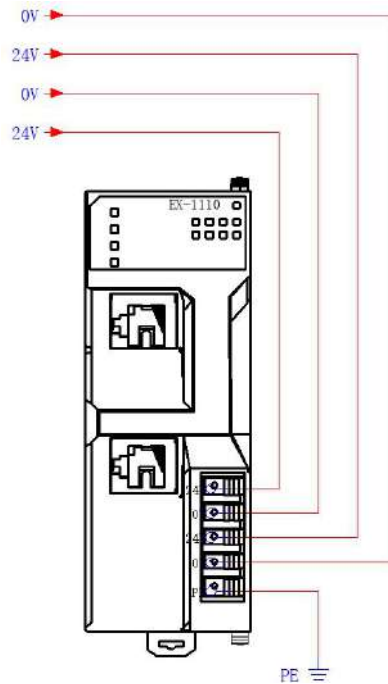

Figure 4-5 Adapter wiring diagram

Note: EX series adapter power supply is divided into system power supply and I/O power supply. To avoid interference to the system, you are advised to connect two sets of power cables from the same DC24V power module to the system power supply and I/O power supply respectively.

4.2.2 Wiring diagram of digital input module

EX series digital quantity input module, EX-2008 /EX-200H input signal is NPN, EX-2108/EX-210H input signal is PNP, EX-203S input signal support NPN and PNP.

- Figure 4-6 shows the wiring diagram of the EX-2008/EX-200H/EX-2108/EX-210H module.

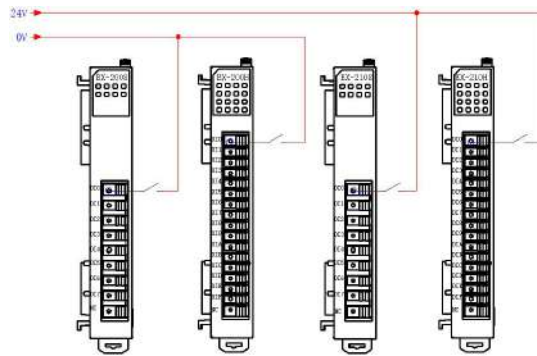

4.2.3 Wiring diagram of digital output module

EX series digital quantity output module, EX-3008 /EX-300H/EX-303S output signal is NPN, EX-3108/EX-310H/EX-313S output signal is PNP, EX-3208 is relay output module.

- Figure 4-9 shows the wiring diagram of the EX-3008/EX-300H/EX-3108/EX-310H module.
- Figure 4-10 shows the ex-3208 module wiring diagram.

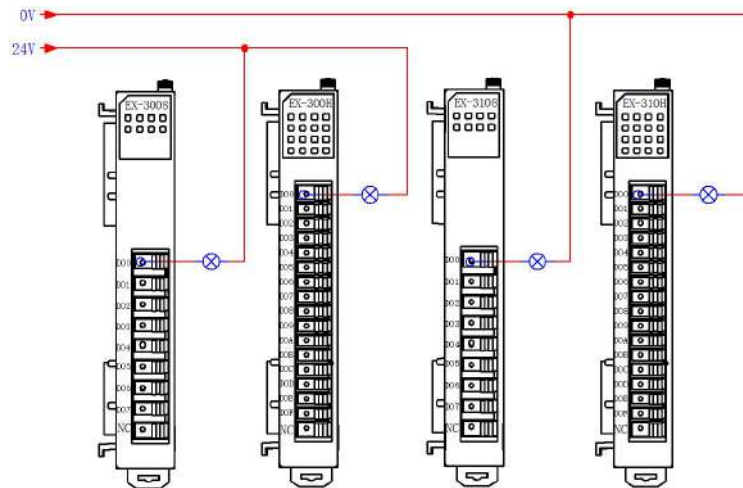

Figure 4-9 EX-3008 /EX-300H/EX-3108/EX-310H module wiring diagram

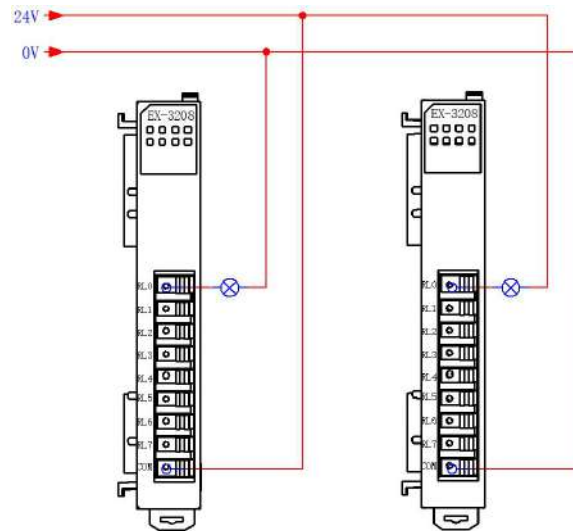

Figure 4-10 Wiring diagram of the EX-3208 relay output module

4.2.4 Analog input module wiring diagram

The analog input module is divided into voltage and current according to the input signal type. The voltage or current type connection mode is two-wire system.

Hint: Enter 2/3/4 and refer to 6.1.8

- Figure 4-11 shows the module wiring diagram for EX-4014, EX-4114, EX-4054, EX-4154, EX-4018, and EX-4118.
- Figure 4-12 shows the wiring diagram for the EX-4414/EX-4454/EX-4418 module.

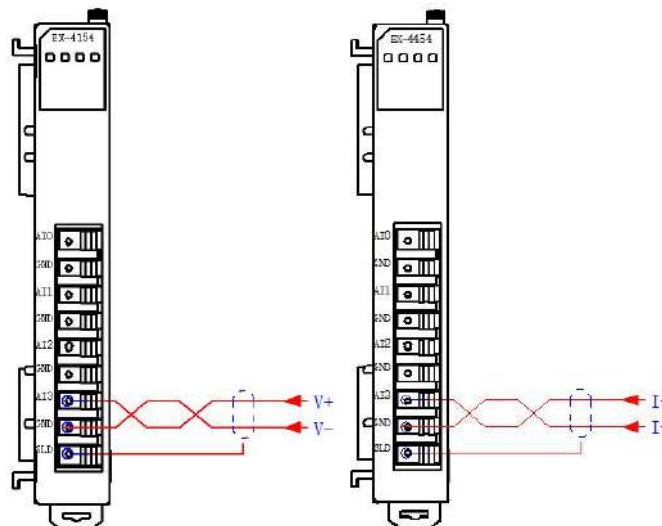

Figure 4-11 Wiring diagram of voltage input signals
current input signals

Figure 4-12 Wiring diagram of

[For three-wire/four-wire connection, please refer to 6.1.8](#)

4.2.5 Analog output module wiring diagram

The analog output module is divided into voltage and current according to the output signal type. The voltage or current type connection mode is two-wire system.

- Figure 4-13 shows the module wiring diagram of ex-5014, EX-5114, EX-5054, EX-5154, EX-5018, and EX-5118.
- Figure 4-14 shows the wiring diagram for the EX-5414/EX-5454/EX-5418 module.

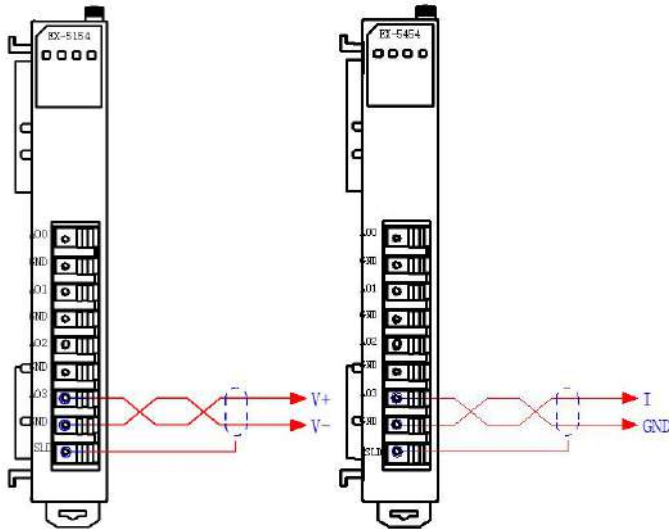

Figure 4-13 Voltage output signal wiring diagram
signal wiring diagram

Figure 4-14 Current type I/O

4.2.6 Temperature Module wiring diagram

EX series products are divided into two types of temperature modules: thermocouple and thermal resistance, with four input channels.

- Figure 4-15 shows the wiring diagram of the EX-4654 module.
- Figure 4-16 shows the wiring diagram of the EX-4754 module.

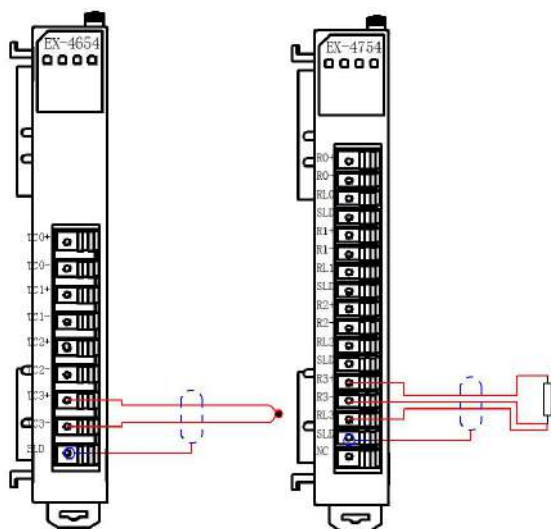

Figure 4-15 Wiring diagram of the EX-4654 module

Figure 4-16 Ex-4754 module

[For three-wire/four-wire connection, please refer to 6.1.8](#)

4.2.7 Wiring diagram of Function Modules

Function module is divided into encoder module and high-speed pulse output module, according to the signal type into differential, NPN, PNP three.

- Figure 4-17 shows the wiring diagram of the EX-6001/EX-6011 encoder (NPN/PNP) module.
- Figure 4-18 shows the wiring diagram of the EX-6021 encoder (differential) module.

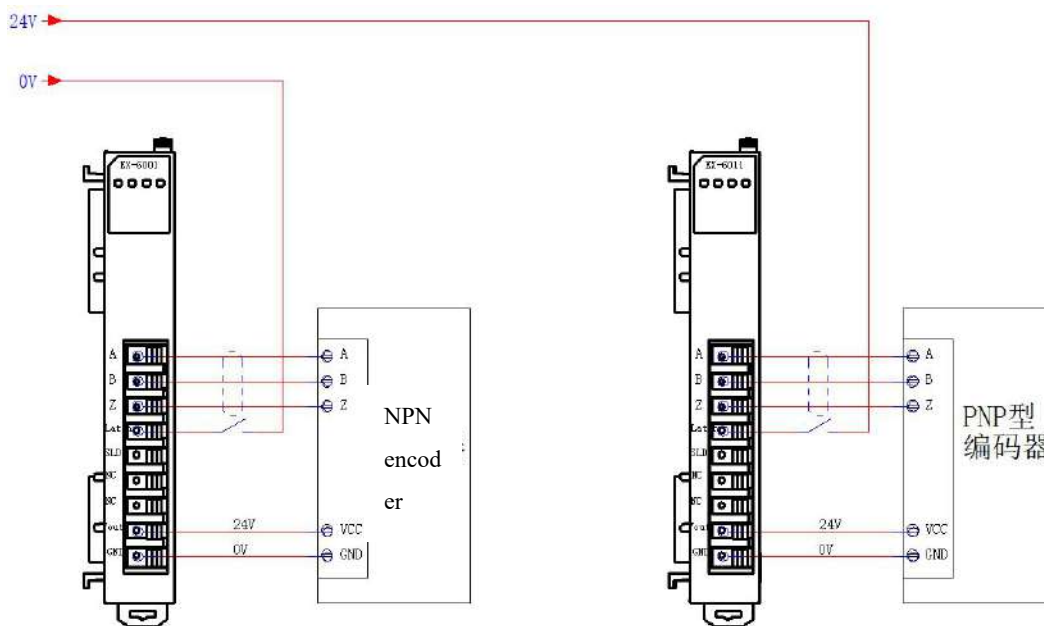

Figure 4-17 Wiring diagram of the EX-6001/EX-6011 encoder module

Note: The longest connection line of NPN/PNP encoder shall not exceed 2m. The Latch input signal type of EX-6001 and EX-6011 is NPN.

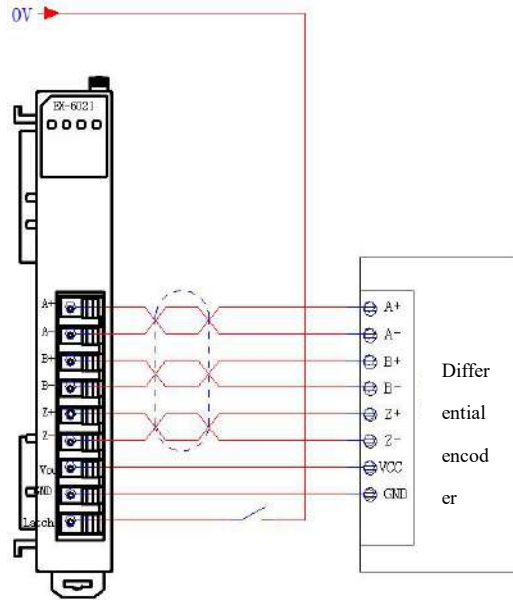
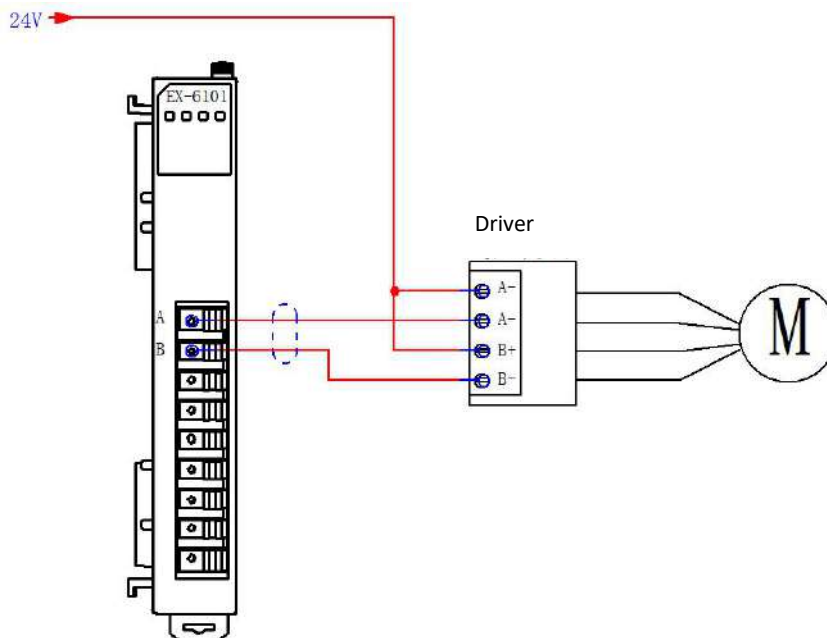

Figure 4-18 Wiring diagram of the ex-6021 encoder module

Note: the longest connection line of differential encoder shall not exceed 10m



4.2.8 Communication Module wiring diagram

- Figure 4-19 shows the wiring diagram of the EX-6301 module.

- Figure 4-20 shows the wiring diagram for the EX-6311 module.
- Figure 4-21 shows the wiring diagram for the EX-6321 module.

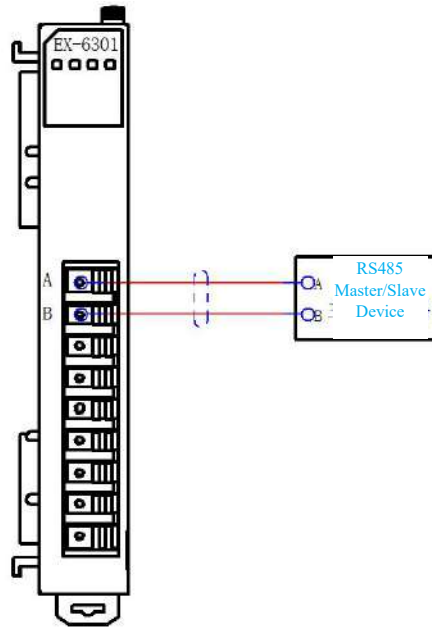

Figure 4-19 Wiring diagram of the EX-6301 module

Note: The communication distance between the EX-6301 module and the RS485 master/slave device depends on the communication medium (such as communication cable or wireless relay) or baud rate.

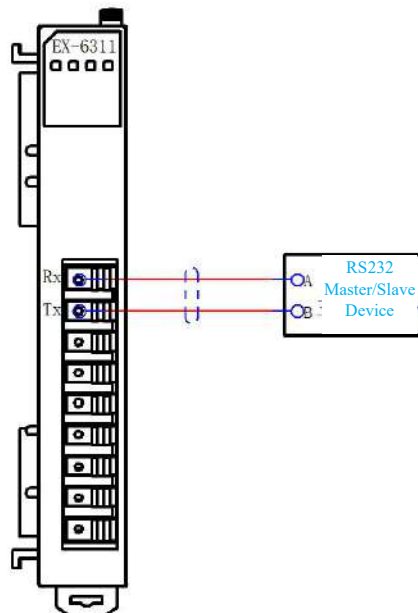

Figure 4-20 Wiring diagram of the EX-6311 module

Note: shielded cables are recommended for the communication distance between the ex-6311 module and the RS232 master/slave device to be less than 15m.

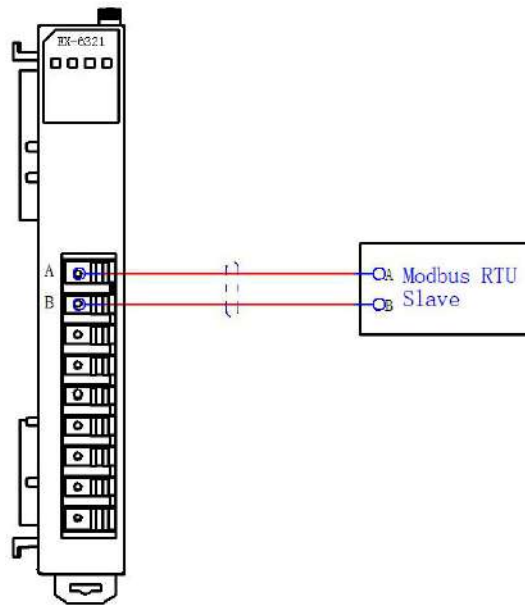

Figure 4-21 Wiring diagram of the EX-6321 module

4.2.9 Power Module Wiring Diagram

The ex-0100 power module needs to be connected to two sets of DC24V power cables. 1L+/1M for the system power supply and 2L+/2M for the I/O power supply. You are advised to connect two sets of power cables from the same DC24V power module to the system power supply and I/O power supply respectively, as shown in figure 4-22.

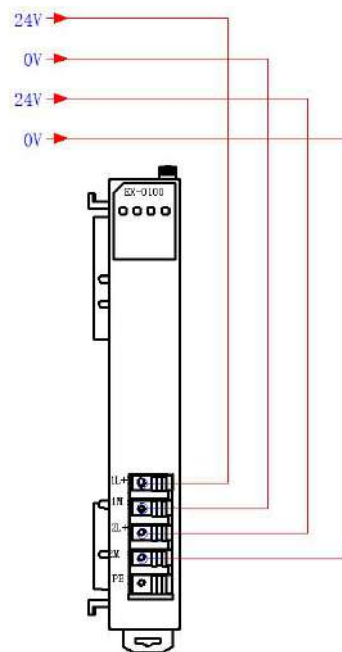

Figure 4-27 Power module wiring diagram

5 EX Remote I/O configuration

This chapter mainly introduces the EX series remote IO adapter with IO module and the current industrial mainstream PLC configuration.

5.1 Connection between Ex-1100 and PLC

5.1.1 Connection and Configuration between TwinCAT2 and EX-1100

1. Communication connection diagram, as shown in Figure 5-1-1.

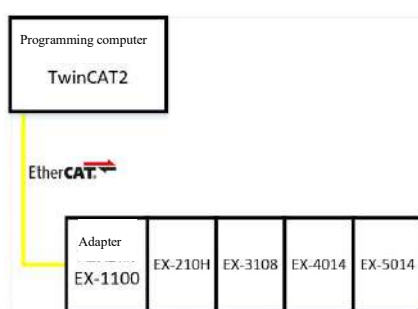

Figure 5-1-1 communication connection diagram

2. Table 5-1-1 shows the hardware configuration

Table 5-1-1 Hardware configuration table

Hardware	Quantity	Note
Computer programming	1	Install TwinCAT2
EX-1100	1	EtherCAT adapter
EX-210H	1	Digital input
EX-3108	1	Digital output module
EX-4014	1	Analog input module
EX-5014	1	Analog output module
Ethernet cable	A number of	

3. Install the XML description file

Install the XML description file into TwinCAT2, as shown in Figure 5-1-2.(TwinCAT2 default path: C: TwinCAT\Io\EtherCAT)

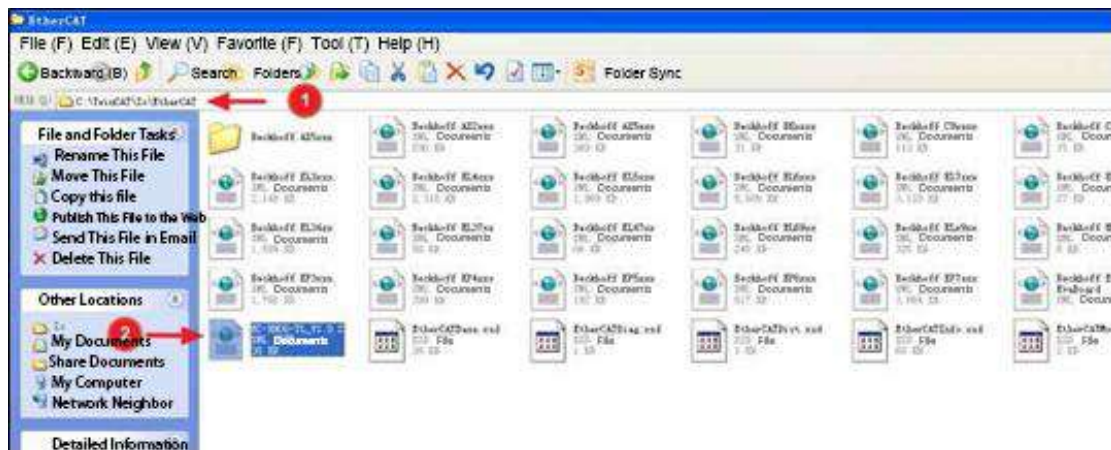

Figure 5-1-2 Installing the XML description file

4. New project and equipment configuration

Click the TwinCAT icon at the lower right corner of the computer and select "System Manager" to open TwinCAT software, as shown in Figure 5-1-3.

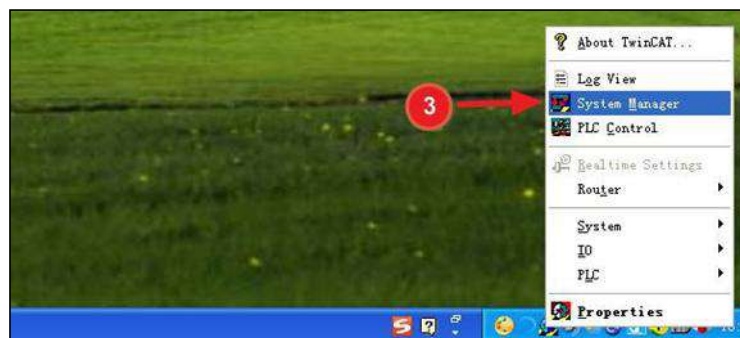

Figure 5-1-3 Starting TwinCAT software

After the TwinCAT software is started, click I/O Devices on the left of the project and right-click Scan Devices, as shown in Figure 5-1-4.

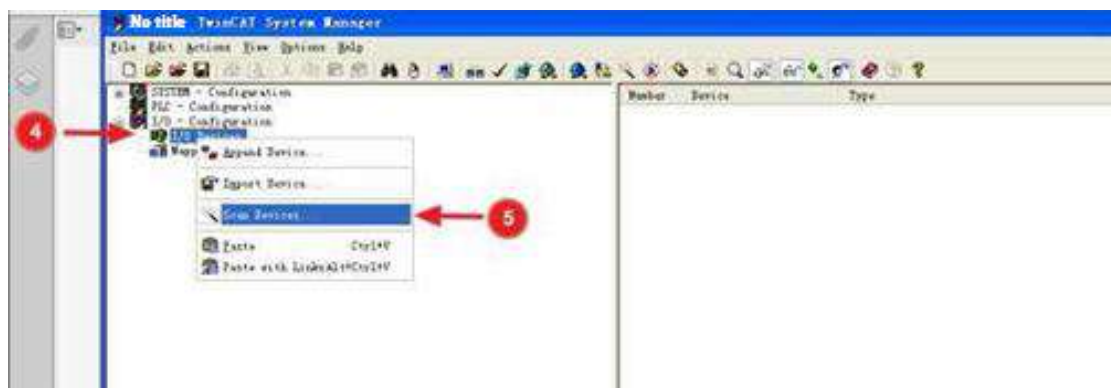

Figure 5-1-4 Selecting Scan Devices

In the New I/O Devices Found window, select the network card that you want to connect to EtherCAT I/O, as shown in Figure 5-1-5.

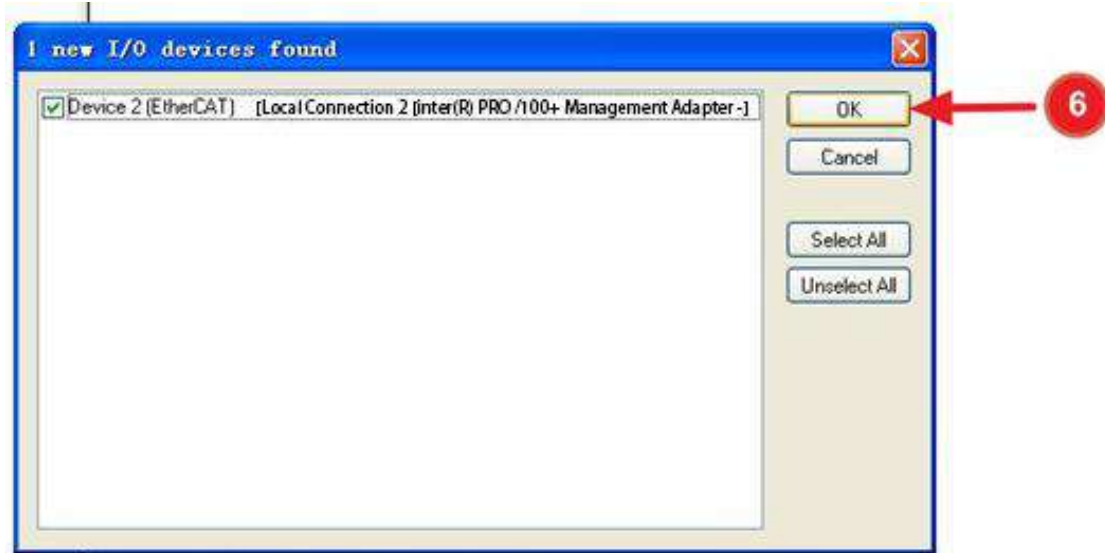

Figure 5-1-5 Selecting a network card

Select "Yes" in the prompt window "Scan for Boxes", and the adapter EX-1100 and the attached I/O module are scanned, as shown in picture 5-1-6.

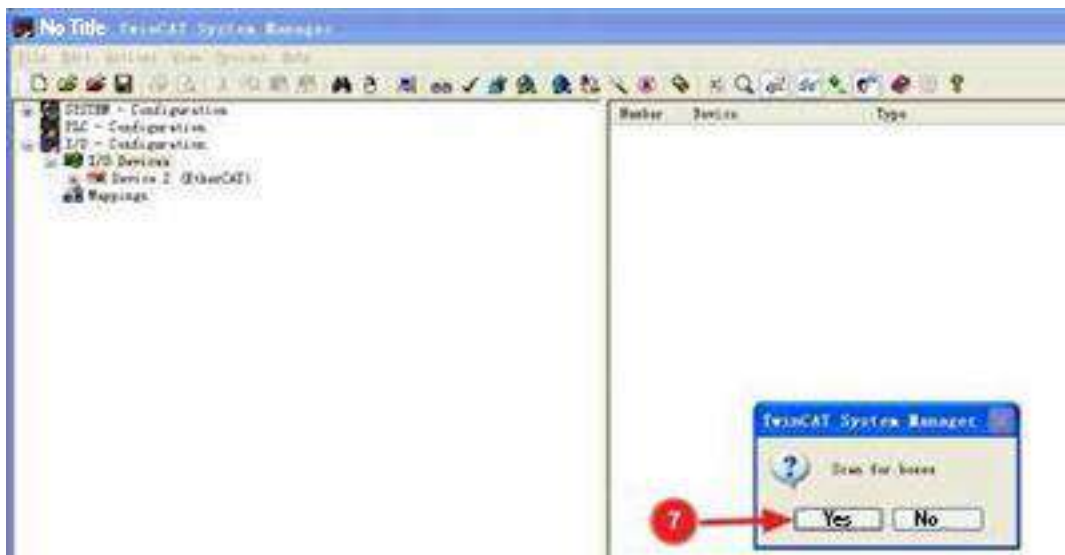

Figure 5-1-6 Scanning the I/O module

5. I/O monitoring and forced output

Choose Box1 (EX-1100) > Module2 (EX-3108) > Channels Date from the left pane of the project. Double-click Channel 1 to pop up the Set Value Dialog window, and Set the mandatory Value to 1, as shown in Figure 5-1-7.

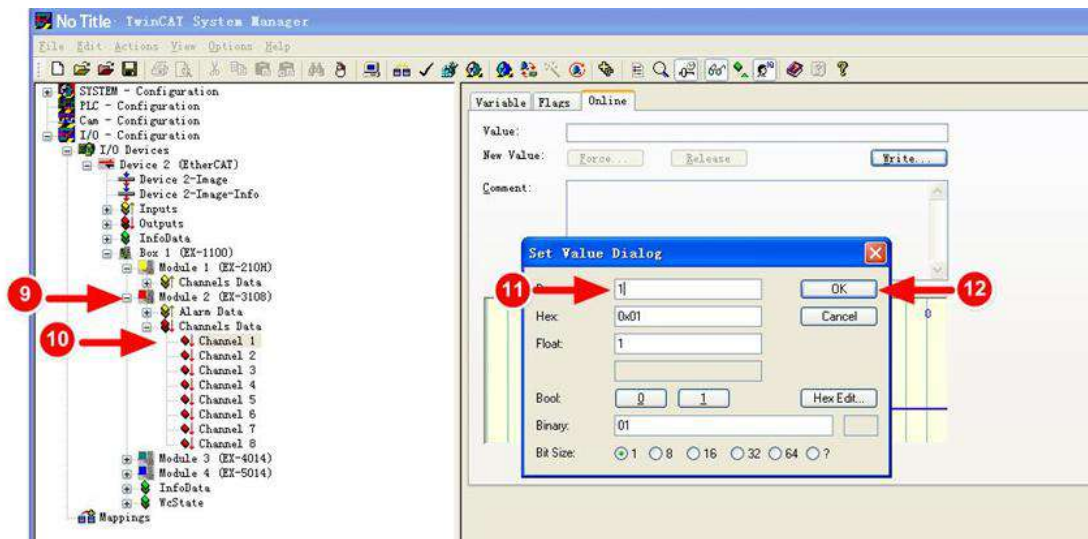
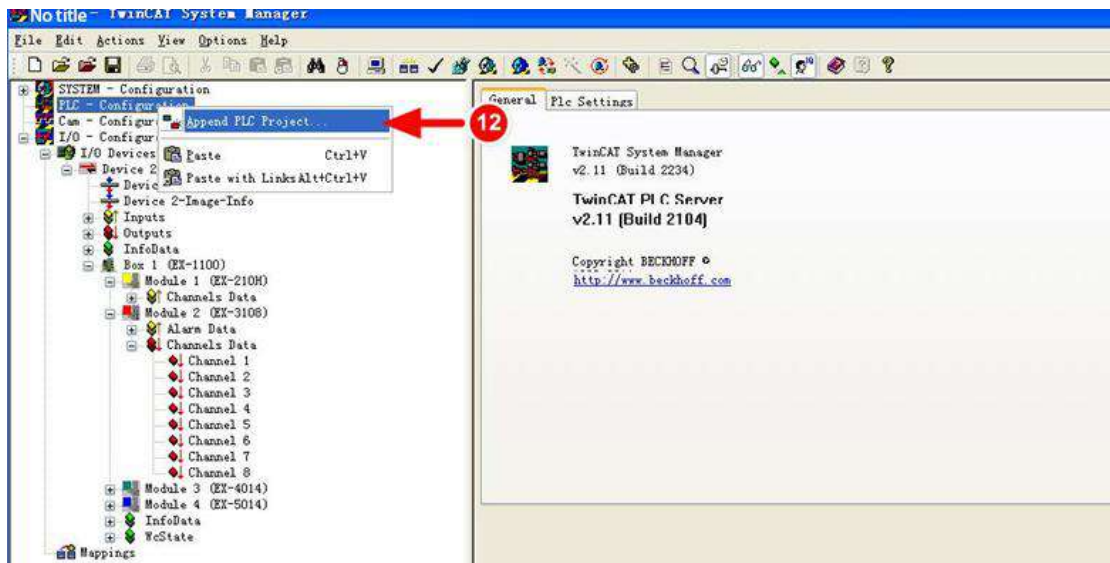

Figure 5-1-7 Mandatory input values

6. Variable association

Right-click PLC-Configuration on the left of the project, select Add PLC project, and associate the defined INPUT and output variables to the I/O channel, as shown in Figure 5-1-8.



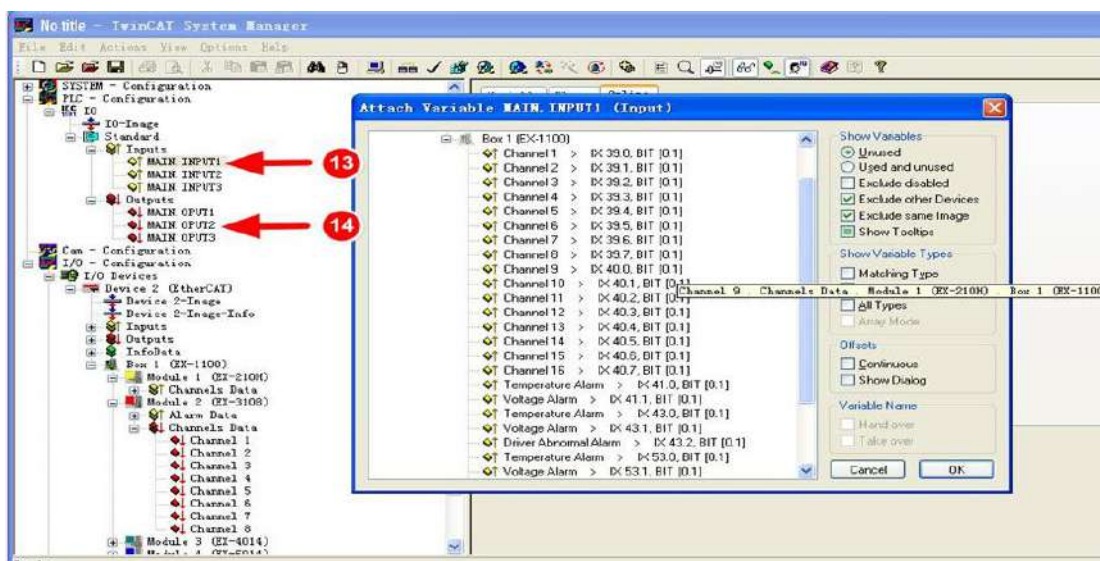

Figure 5-1-8 Correlation of variables

5.1.2 Connection and Configuration between TwinCAT3 and EX-1100

1. Communication connection diagram, as shown in Figure 5-1-9.

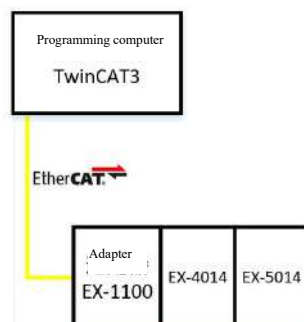

Figure 5-1-9 Communication connection diagram

2. Table 5-1-2 shows the hardware configuration

Table 5-1-2 Hardware configuration table

Hardware	Quantity	Note
Computer programming	1	Install TwinCAT3
EX-1100	1	EtherCAT adapter
EX-4014	1	Analog input module
EX-5014	1	Analog output module
Ethernet cable	A number of	

3. Install the XML description file

Install the XML description file into TwinCAT3, as shown in figure 5-1-10. The example default folder is

(C:\TwinCAT\ \ Config \ Io \ EtherCAT 3.1)

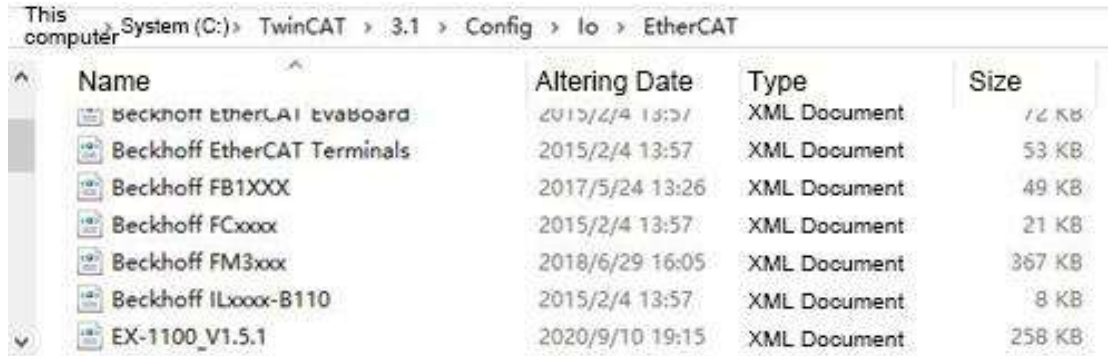

Figure 5-1-10 Installing the XML description file

4. New project and equipment configuration

Open TwinCAT3 software and choose "File" > New > Project from the menu bar, as shown in Figure 5-1-11. In the window of new Project, select "TwinCAT Projects", as shown in Figure 5-1-12.



Figure 5-1-11 New project

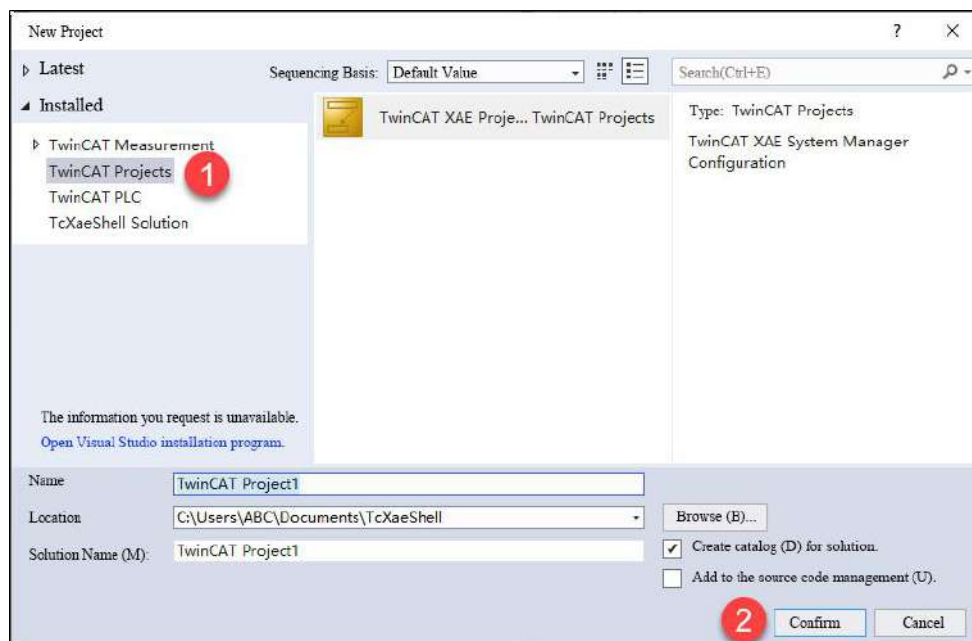

Figure 5-1-12 Selecting TwinCAT Project

Scan the IO connected to the programming computer into the project. Click "I/O" > "Devices" > "Scan" in the project tree, as shown in Figure 5-1-13. The hardware configuration displayed in the Scan is shown in Figure 5-1-14.

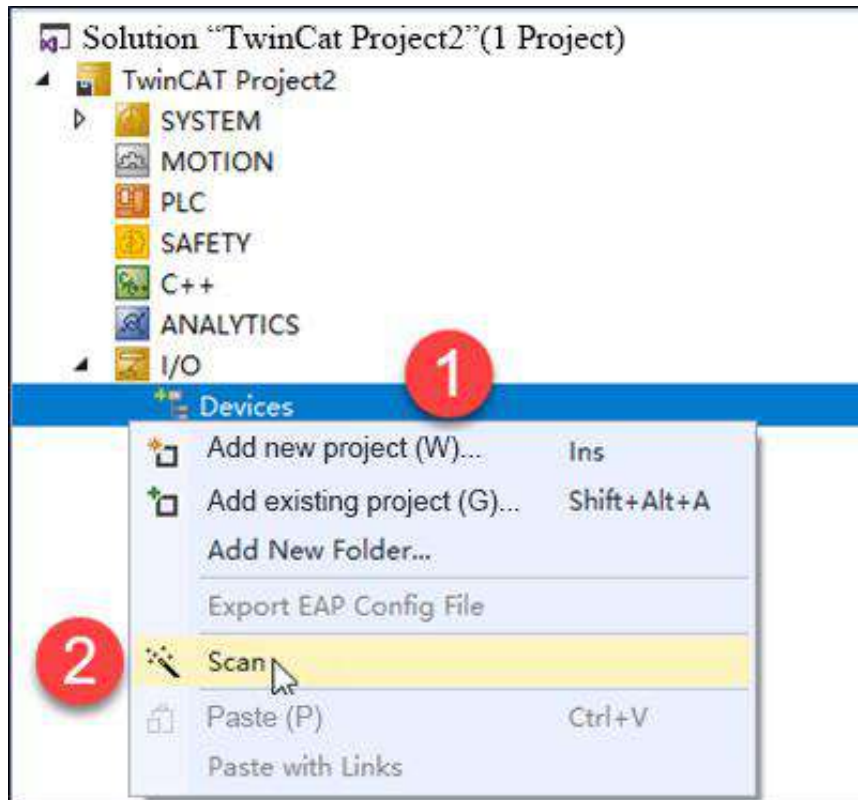

Figure 5-1-13 Scanning I/O devices

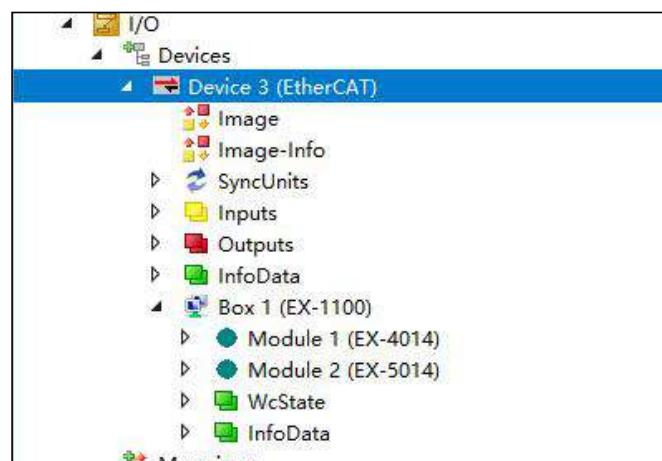

Figure 5-1-14 Hardware configuration

5. IO monitoring and forced output

In the project tree, choose I/O > Devices > Device3 (EtherCAT) > Box1 (EX-1100) > Module2 (EX-5014) > Channels Data. Double-click Channel 0. Choose Online > Write and force the value to 1000, as shown in Figure 5-1-15. Figure 5-1-16 shows the monitoring result.

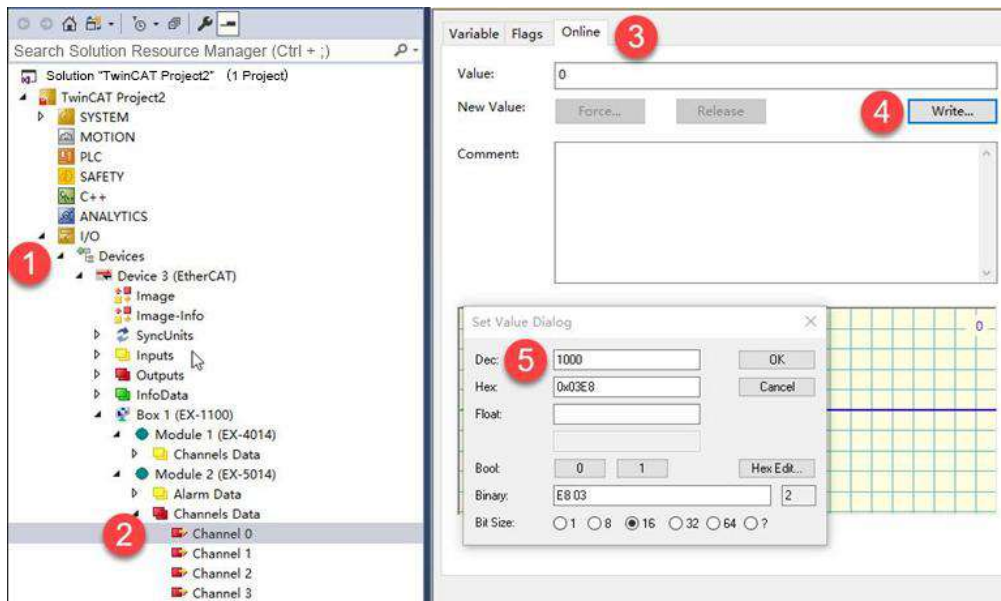

Figure 5-1-15 Forcing write values

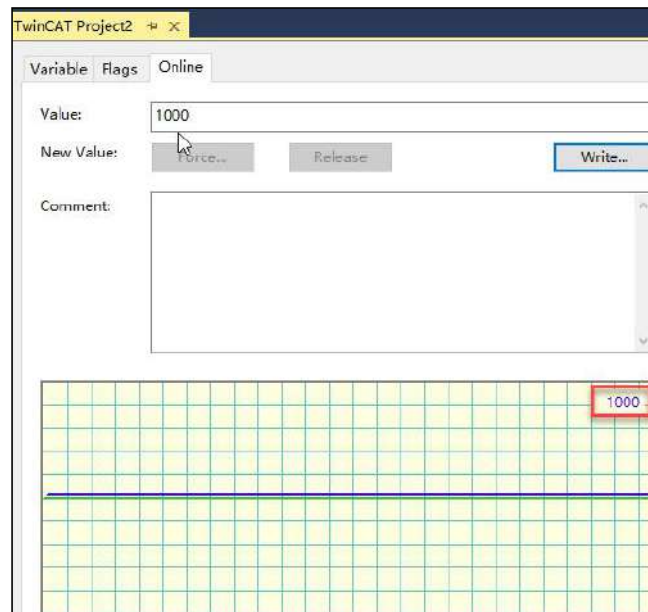

Figure 5-1-16 Monitoring results

5.1.3 Connection and Configuration of CODESYS and EX-1100

1. Communication connection diagram, as shown in Figure 5-1-17.

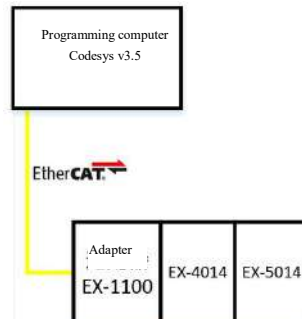

Figure 5-1-17 Communication connection diagram

2. The hardware configuration is shown in Table 5-1-3

Table 5-1-3 Hardware configuration table

Hardware	Quantity	Note
Computer programming	1	Install the Codesys V3.5
EX-1100	1	EtherCAT adapter
EX-4014	1	Analog input module
EX-5014	1	Analog output module
Ethernet cable	A number of	

3. Install the XML description file

Open CODESYS V3.5 and choose Tools > Device Repository from the menu bar, as shown in Figure 5-1-18.

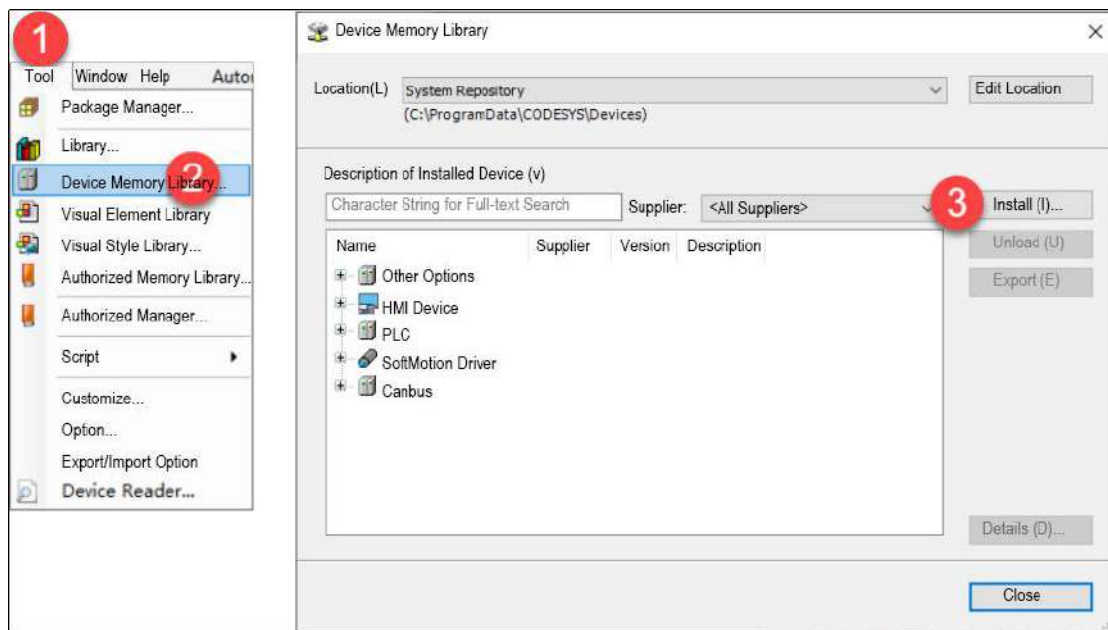

Figure 5-1-18 Installing the XML device description file

4. New project and equipment configuration

Open CODESYS V3.5 software and choose "New Project" > "Project" > "Standard Project", as shown in Figure 5-1-19.

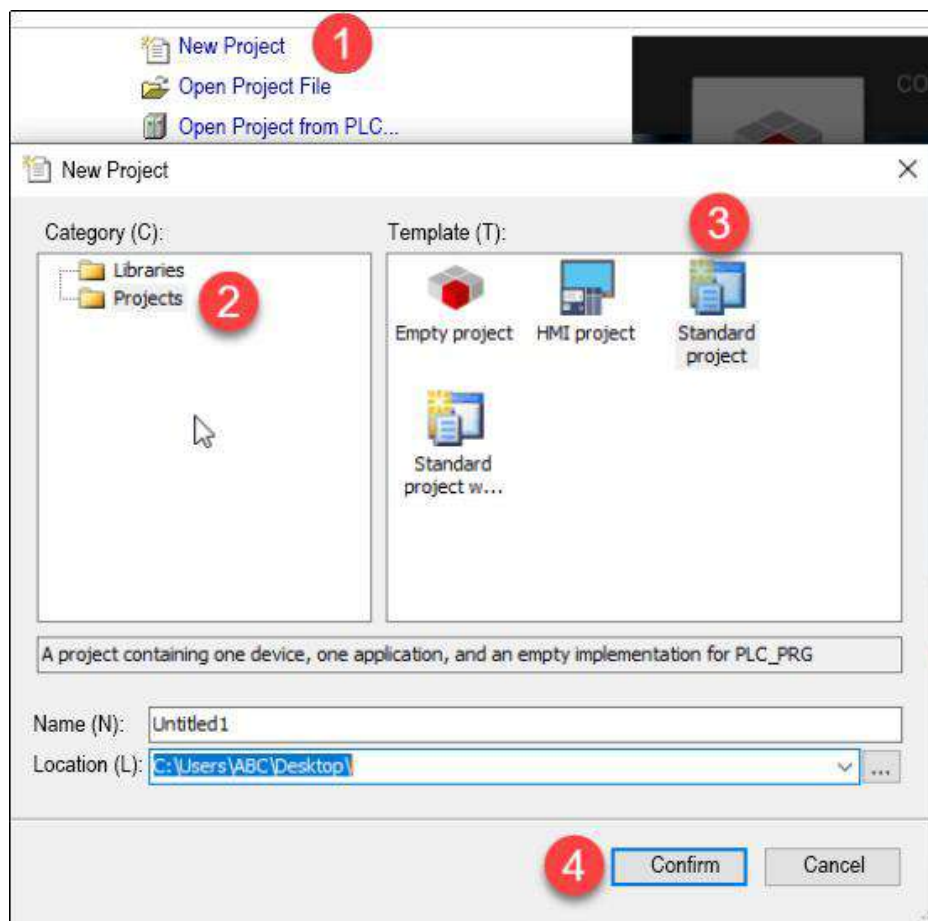

Figure 5-1-20 New construction project

In the standard engineering window, select CODESYS SoftMotion Win V3 for device and Structured Text (ST) for PLC_PRG programming language, as shown in Figure 5-1-21.

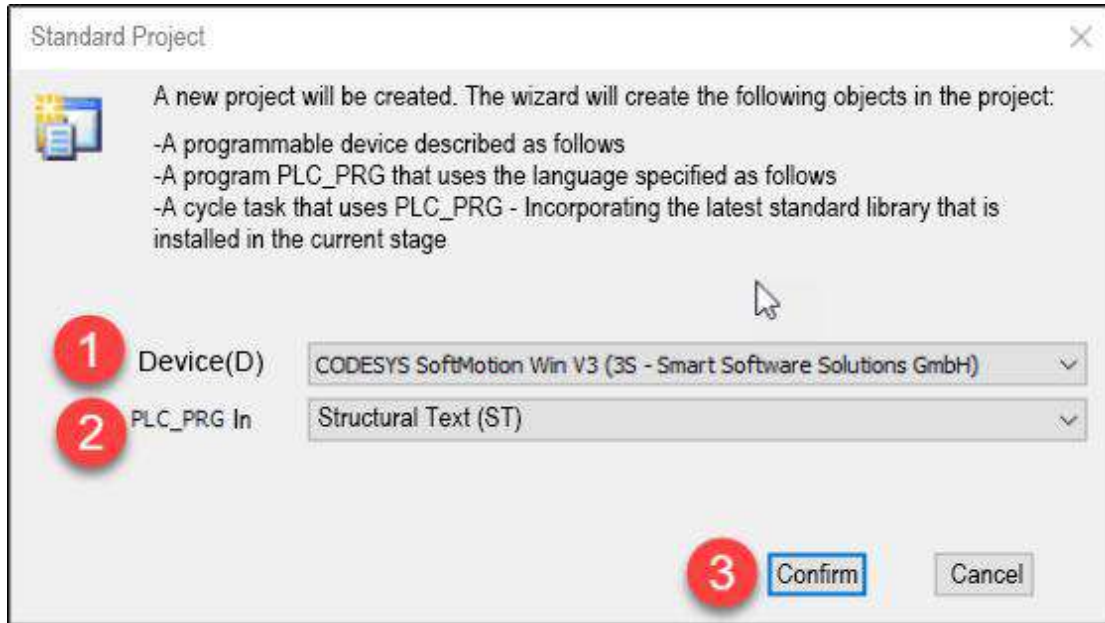

Figure 5-1-21 Selecting device and programming language

Note: Softmotion can bring driver and I/O, Control can only bring I/O and can not bring driver.

In the Device tree, choose Device (CODESYS SoftMotion Win V3) > Add Device, as shown in Figure 5-1-22. In the Device adding window, choose FieldBus > EtherCAT > EtherCAT Master, as shown in Figure 5-1-23.

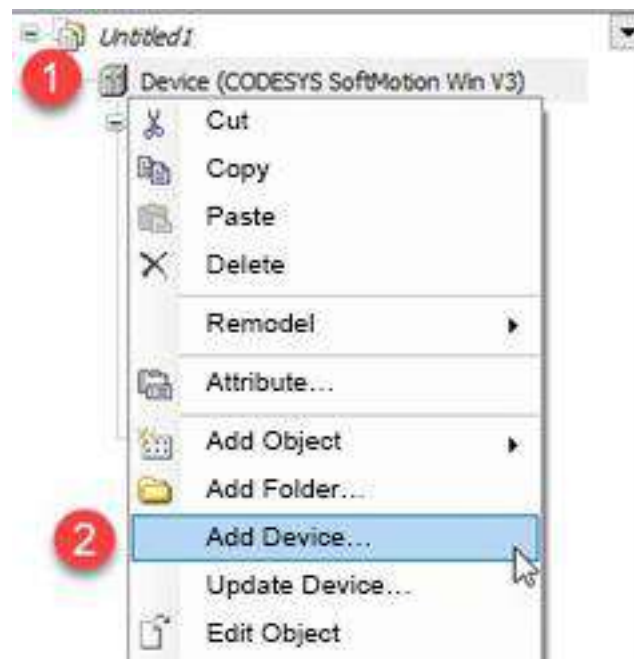

Figure 5-1-22 Adding devices

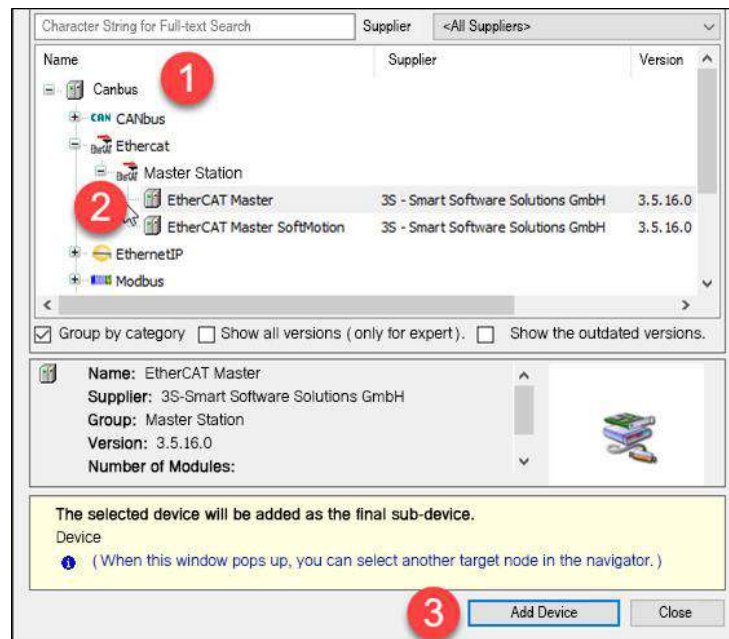

Figure 5-1-23 Selecting the EtherCAT bus

To assign a network port to EtherCAT Master, double-click "EtherCAT_Master" > "EtherCAT NIC Settings" > "Browse" in the device tree, as shown in Figure 5-1-24.

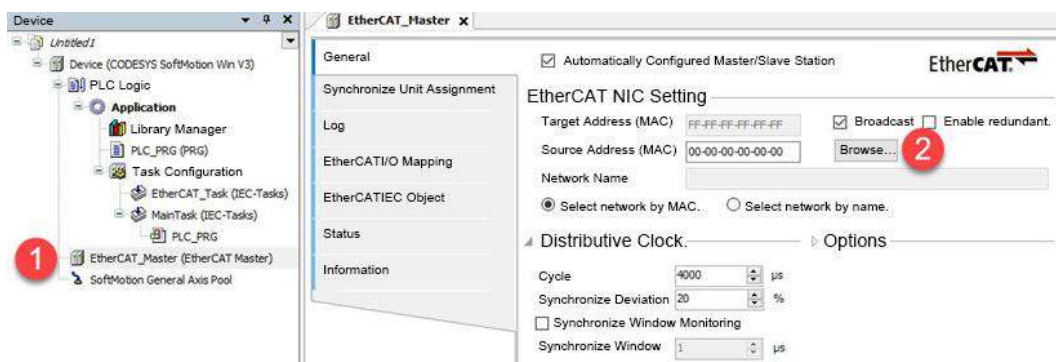

Figure 5-1-24 Assigning network ports

Tip: Before assigning network ports, you need to download the project to the controller

Scan the actual hardware configuration into the project, right click "EtherCAT_Master" > "Scan Device", and you can see the actual hardware configuration in the scanning window, as shown in Figure 5-1-25.

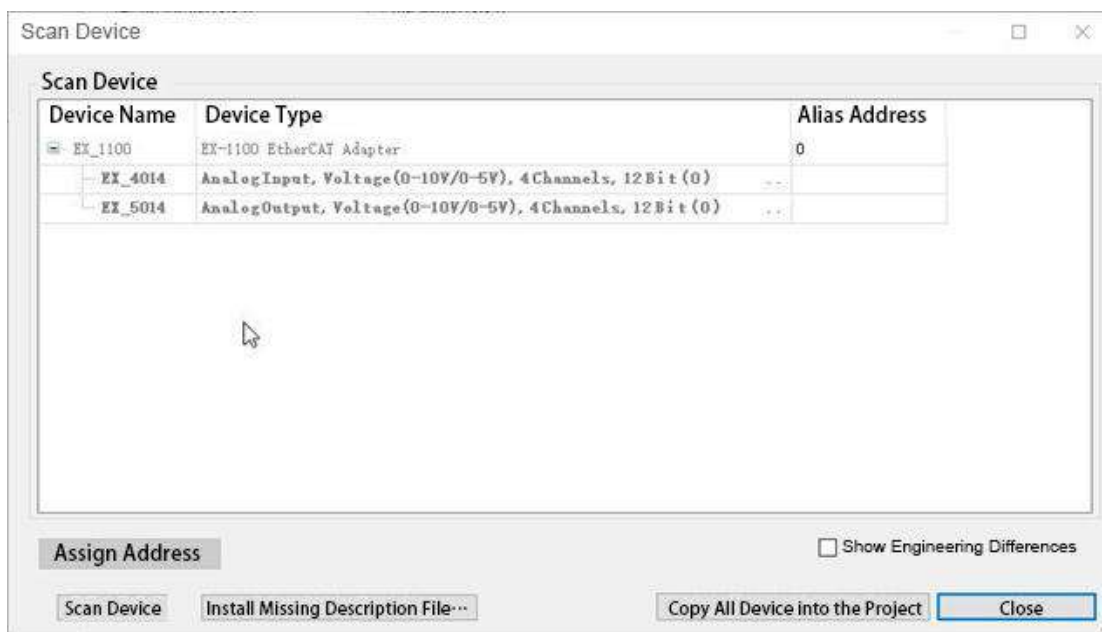

Figure 5-1-25 Scanning equipment

5. The program is downloaded, run and monitored. The monitoring results are shown in Figure 5-1-26.

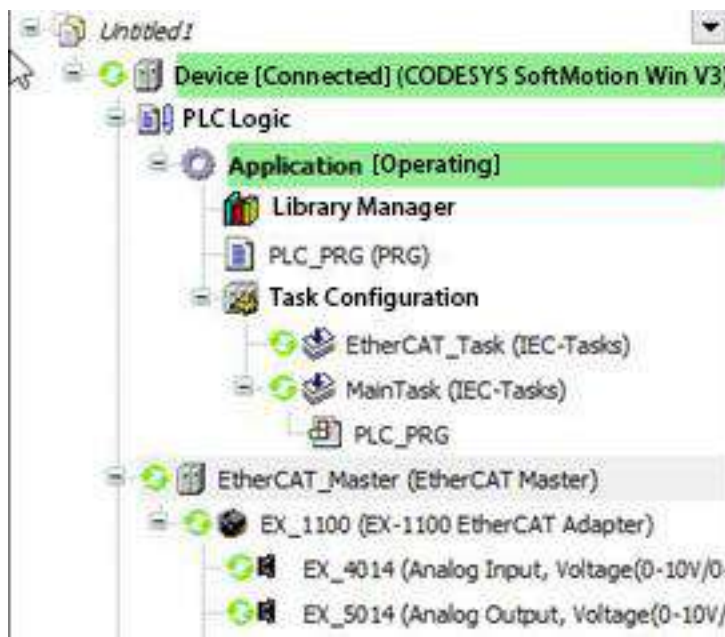

Figure 5-1-26 Monitoring results

5.1.4 Connection and Configuration between Sysmac Studio and EX-1100

1. Communication connection diagram, as shown in Figure 5-1-27.

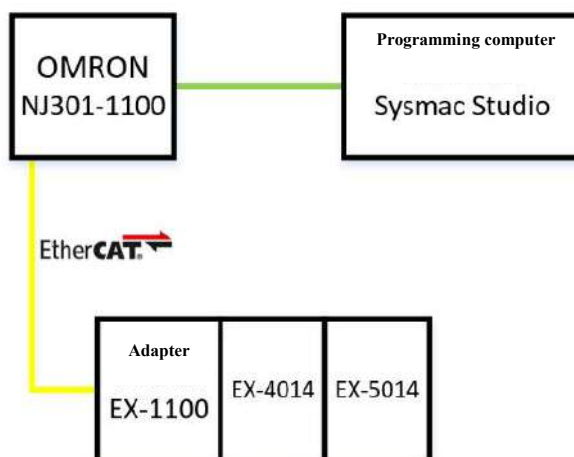

Figure 5-1-27 Communication connection diagram

2. Table 5-1-4 shows the hardware configuration

Table 5-1-4 Hardware configuration table

Hardware	Quantity	Note
Computer programming	1	Sysmac Studio
The controller	1	NJN301-1100
EX-1100	1	EtherCAT adapter
EX-210H	1	Digital quantity input module
EX-3108	1	Digital measuring heat output module
EX-4014	1	Analog input module
EX-5014	1	Analog output module
Ethernet cable	A number of	

3. Install the XML description file

Install the XML description file into Sysmac Studio, as shown in Figure 5-1-28. Example Default folder

C:\ProgramFiles(x86)\OMRON\SysmacStudio\IODeviceProfiles\EsiFiles\UserEsiFiles

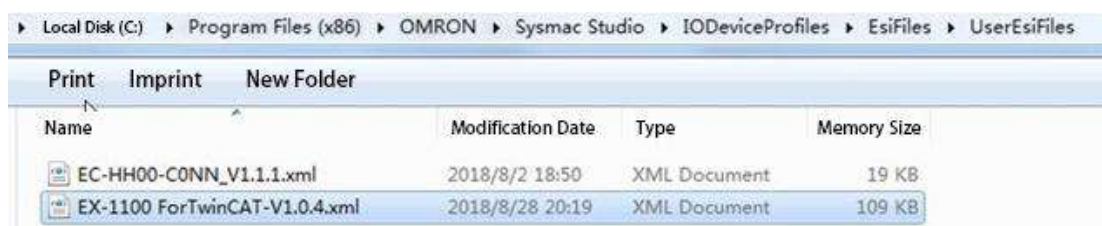

Figure 5-1-28 Installing the XML description file

4. New project and equipment configuration

Open Sysmac Studio, select New Project, and configure the device model and version number, as shown in Figure 5-1-29.

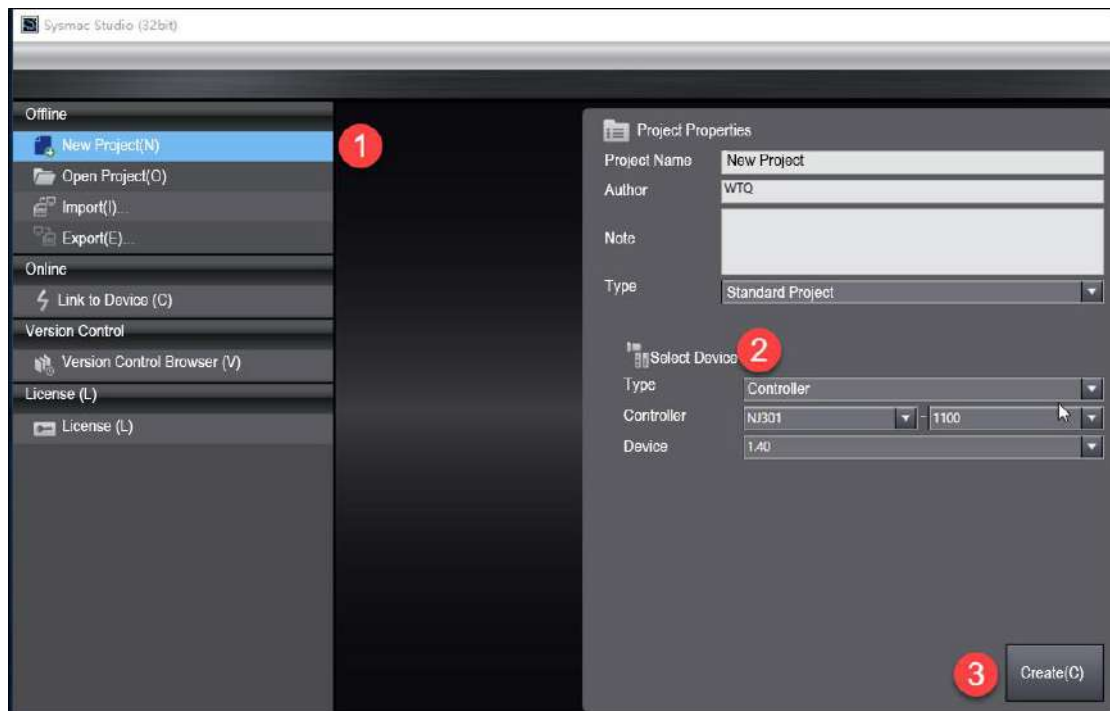

Figure 5-1-29 New construction project

Add the adapter, double-click EtherCAT in the multi-view browser, select Well-Link IO in the toolbox, and select EX-1100 Rev at the bottom of the toolbox, as shown in Figure 5-1-30.

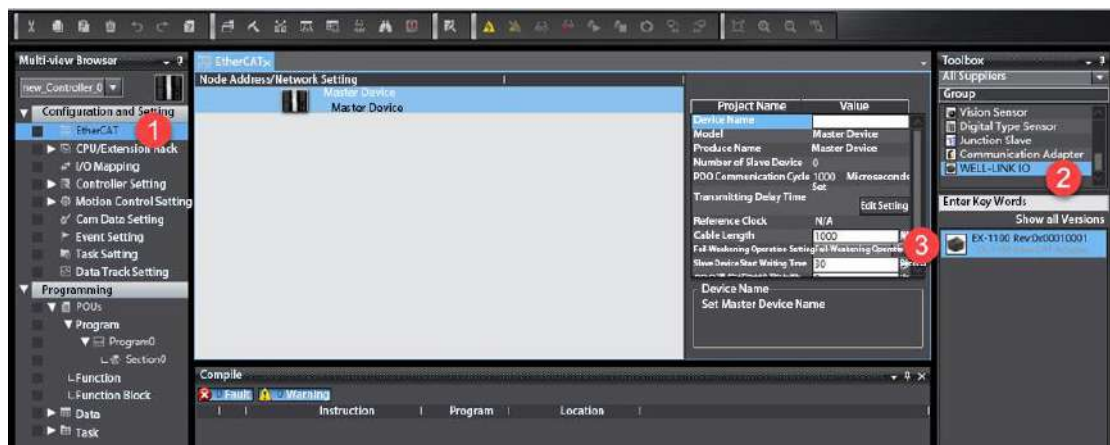

Figure 5-1-30 Adding an adapter

In the EtherCAT view, click ex-1100 and choose edit Module Configuration, as shown in Figure 5-1-31. I/O configuration is performed according to the actual I/O hardware configuration, as shown in Figure 5-1-32.

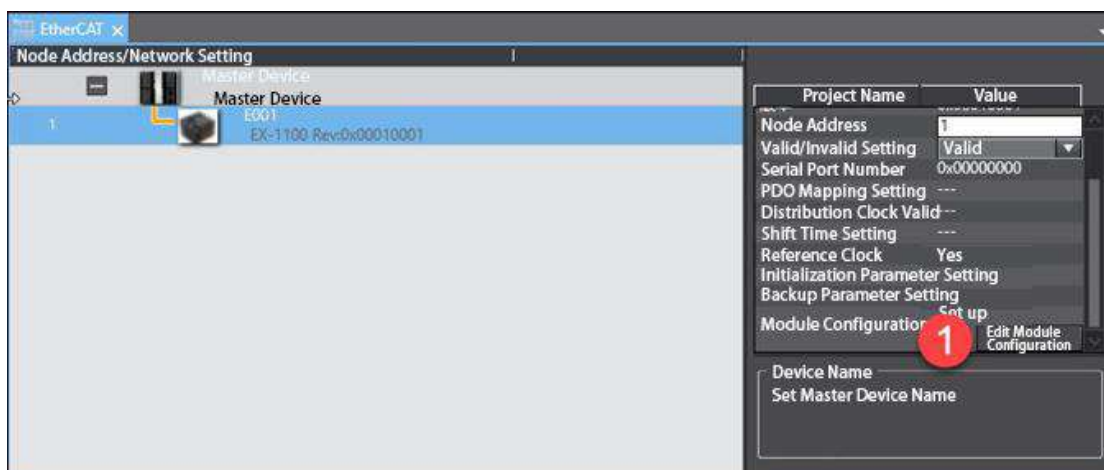

Figure 5-1-31 Edit module configuration

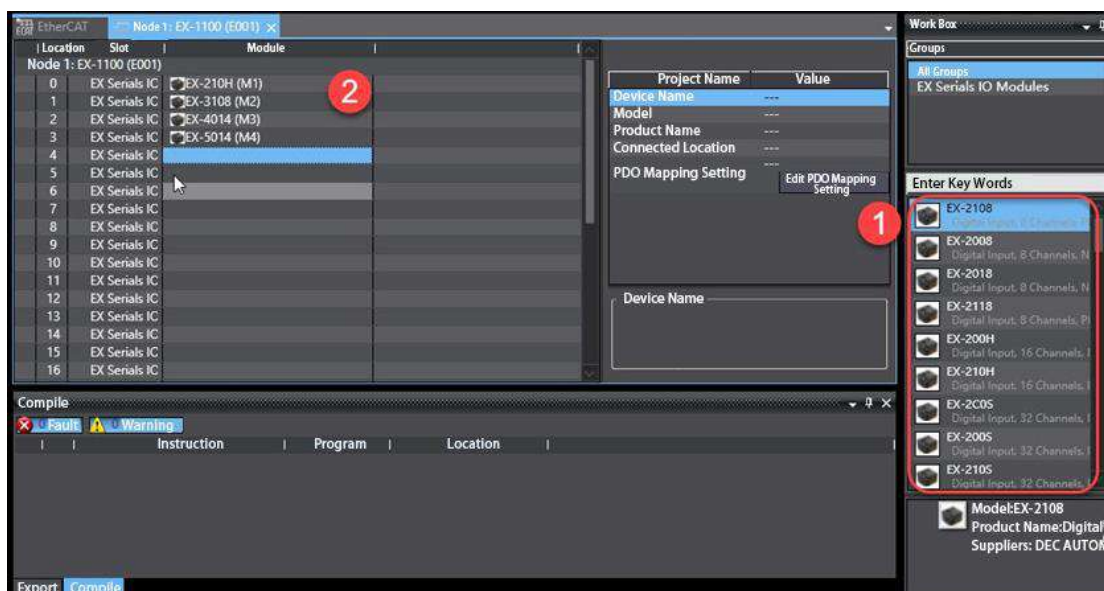

Figure 5-1-32 I/O configuration

Click the online icon, right-click on the icon of the master device, and select Write slave device node address (well-link EtherCAT slave device default node is 0, so the node number must be set), as shown in Figure 5-1-33.

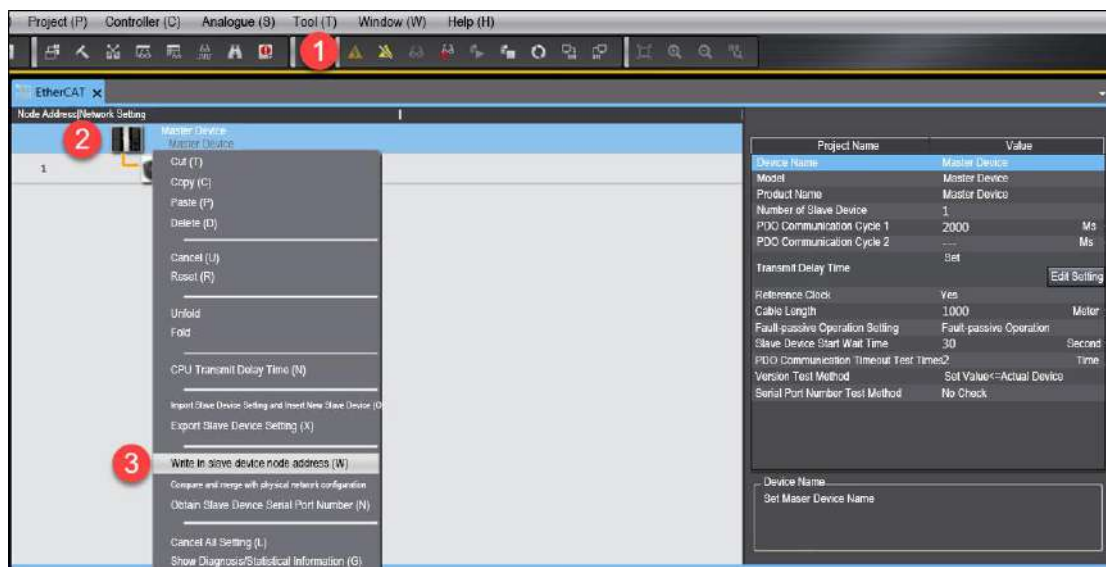

Figure 5-1-33 Node address writing

Note: After the node address is written, the device needs to be restarted for the node address to take effect.

After the device is restarted, download the program to the controller. Choose Controller > Transferring > Transfer to Controller (T) from the menu bar, as shown in Figure 5-32. Then download the program, as shown in Figure 5-1-34.

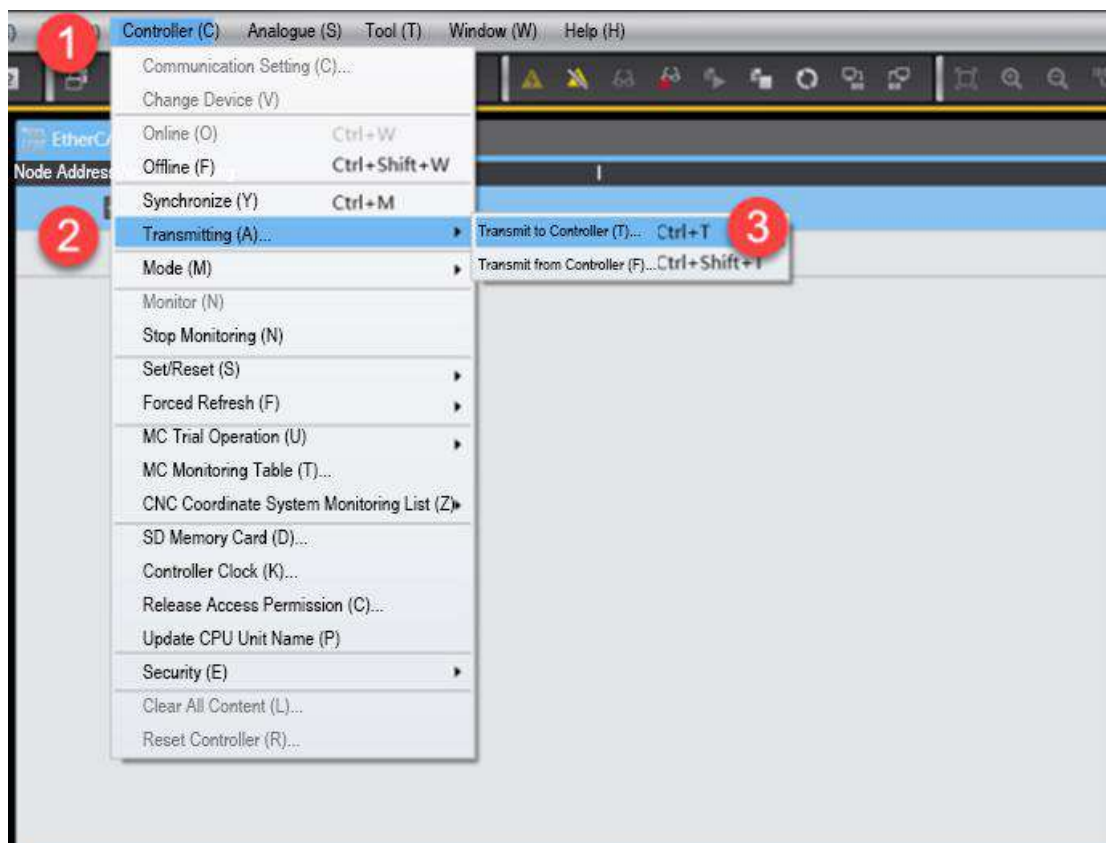

Figure 5-1-34 Program download

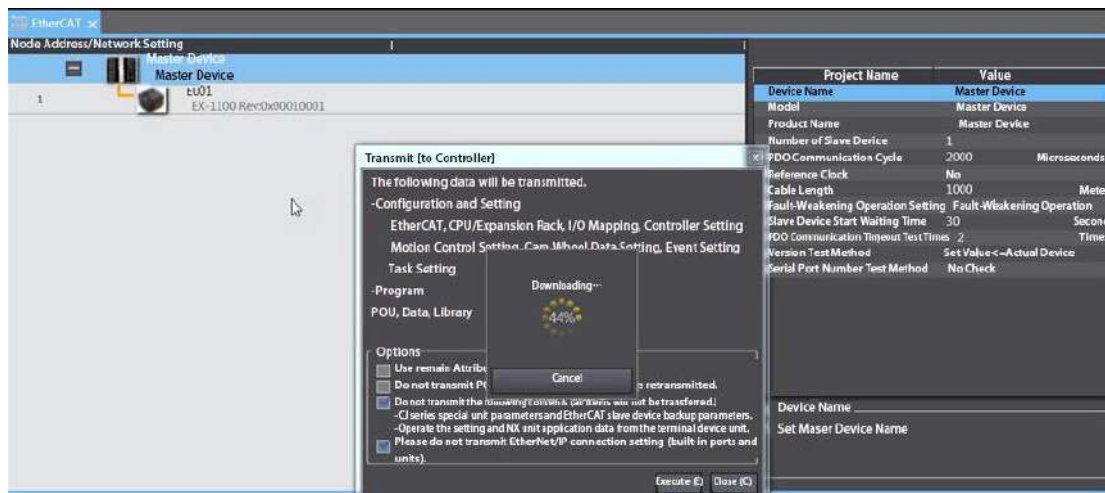

Figure 5-1-35 Performing the download

5.2 Connection between EX-1110 and PLC

5.2.1 Connection and Configuration between TIA Portal and EX-1110

1. Communication connection diagram, as shown in Figure 5-2-1.

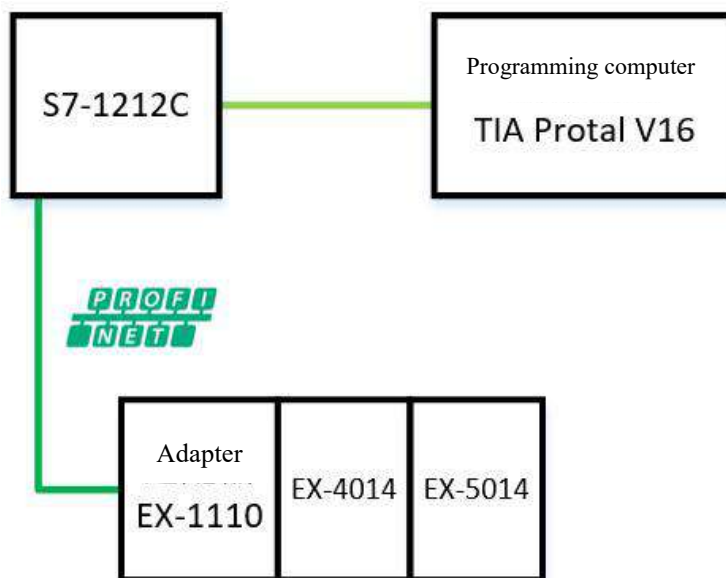

Figure 5-2-1 Communication connection diagram

2. Table 5-2-1 shows the hardware configuration

Table 5-2-1 Hardware configuration table

Hardware	Quantity	Note

Computer programming	1	Install TIA Portal V16
The controller	1	S7-1212C
EX-1110	1	PROFINET adapter
EX-4014	1	Analog input module
EX-5014	1	Analog output module
Ethernet cable	A number of	

3. Install the GSD file

Open TIA Portal V16 and choose Options > Support Device Description File (GSD) from the menu bar, as shown in Figure 5-2-2.

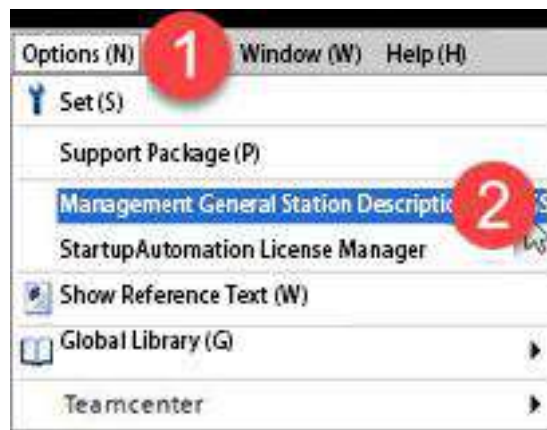

Figure 5-2-2 Installing GSD files

4. New project and equipment configuration

Open TIA Portal V16, select a new project and configure it, as shown in Figure 5-2-3.

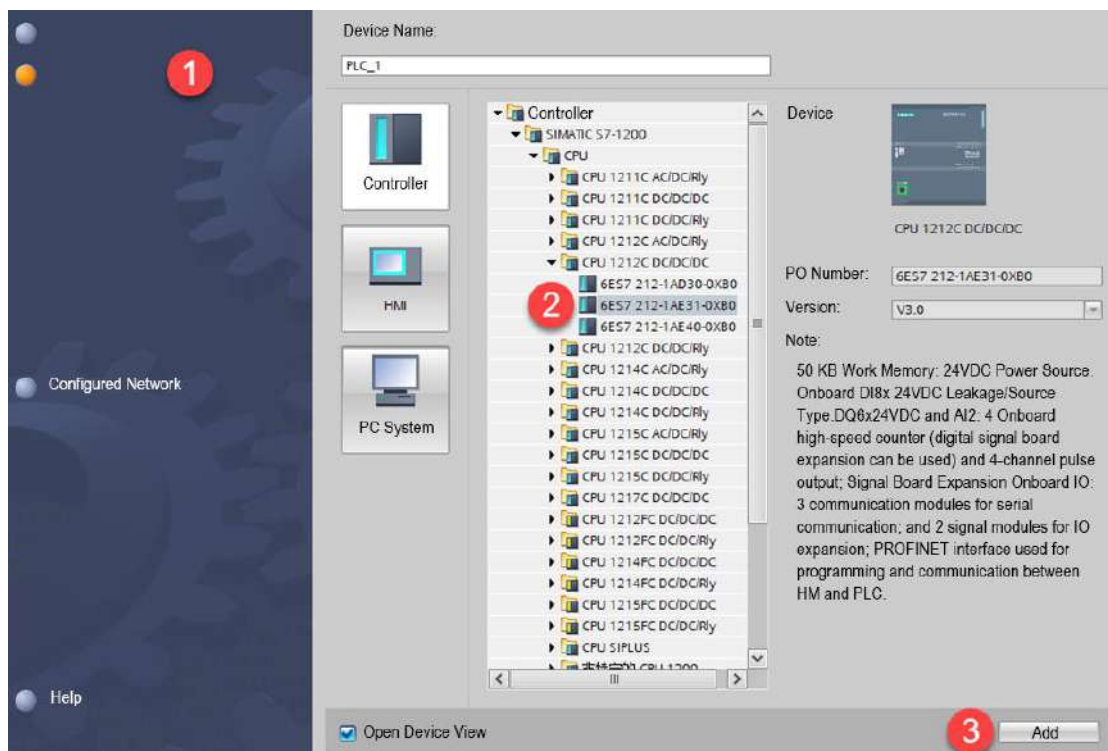

Figure 5-2-3 New construction project

To configure the device, expand the hardware directory in the network view and select the adapter, as shown in Figure 5-2-4. Double-click the adapter to enter the CONFIGURATION I/O module in the device view, as shown in Figure 5-2-5.

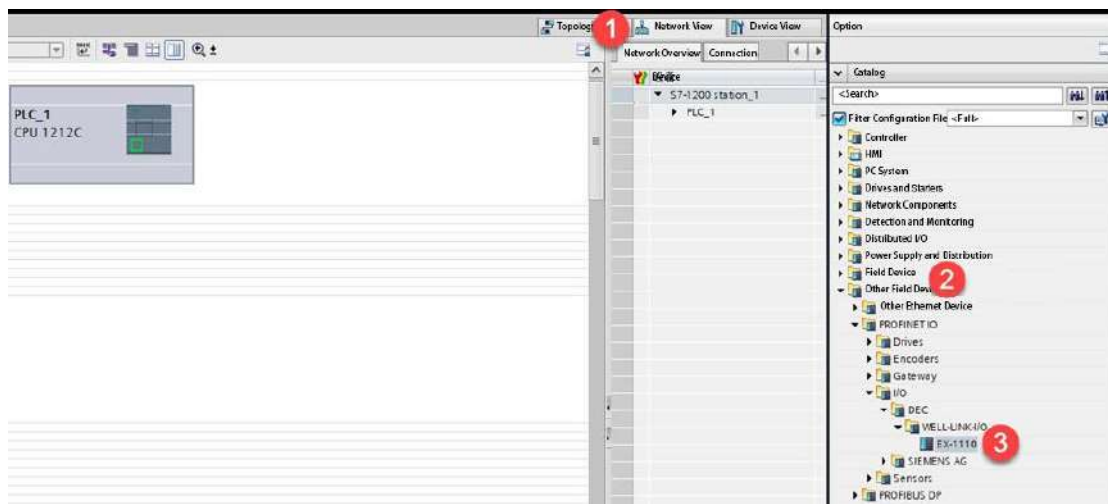

Figure 5-2-4 Configuring devices

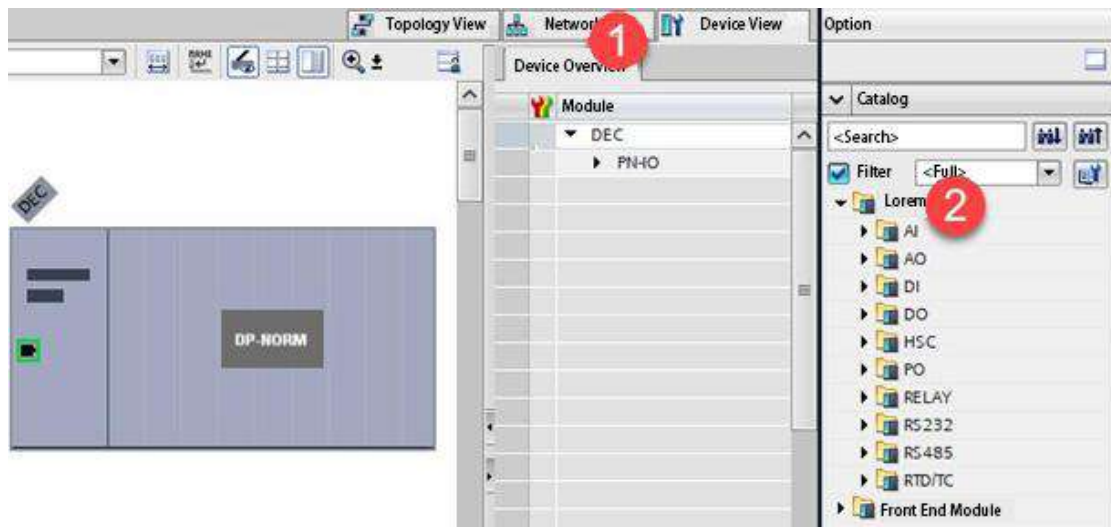

Figure 5-2-5 CONFIGURED I/O module

To assign controllers to I/Os in the network view, click Unassigned in the I/O module and select PLC_1.PROFINET interface_1, as shown in Figure 5-2-6.

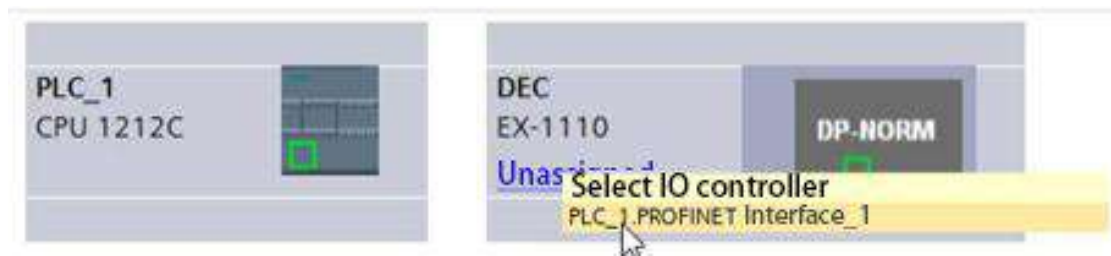

Figure 5-2-6 Assigning IO controllers

Set the IP address of the I/O module. In the device view, double-click the module to go to the properties view, as shown in Figure 5-2-7.

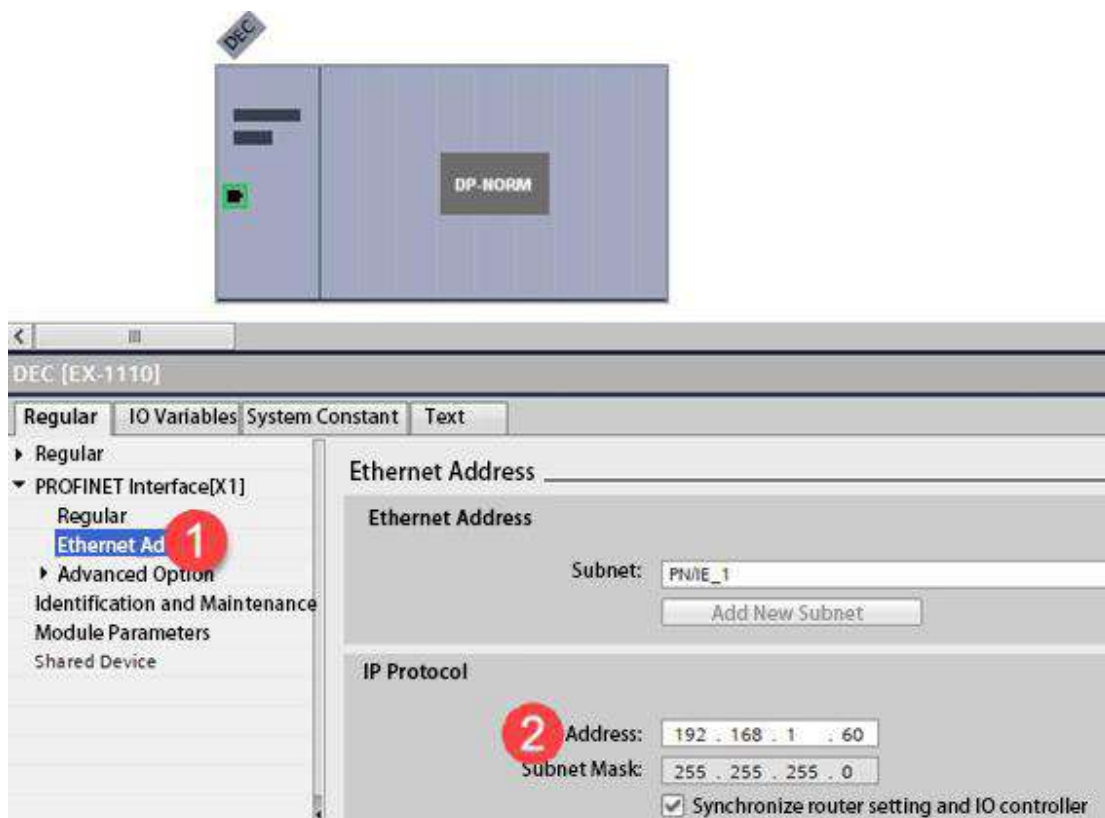

Figure 5-2-7 Assigning IP addresses

Assign a device name to a remote I/O module. Right-click the module and choose Assign Device Name, as shown in Figure 5-2-8. Select the interface type, update the list, and assign the device name, as shown in Figure 5-2-9.

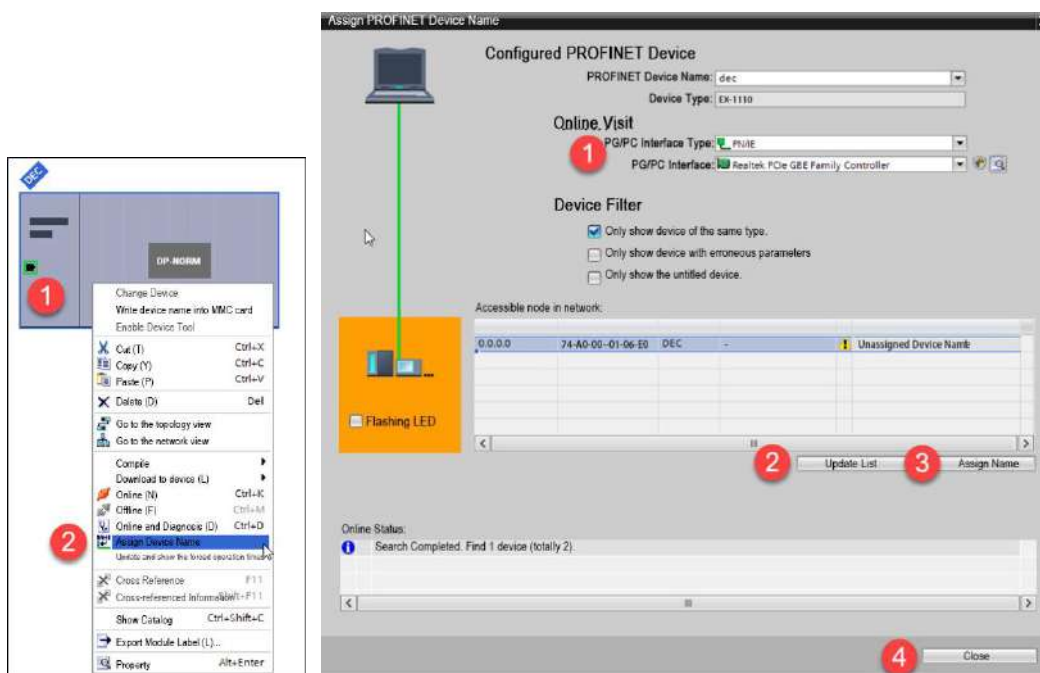

Figure 5-2-8 Assigning device names Figure 5-2-9 Writing device names

5. Program download and equipment monitoring

Select all devices in the network view and download, as shown in Figure 5-2-10. After downloading the program, start CPU operation and switch to online monitoring for normal communication, as shown in Figure 5-2-11.

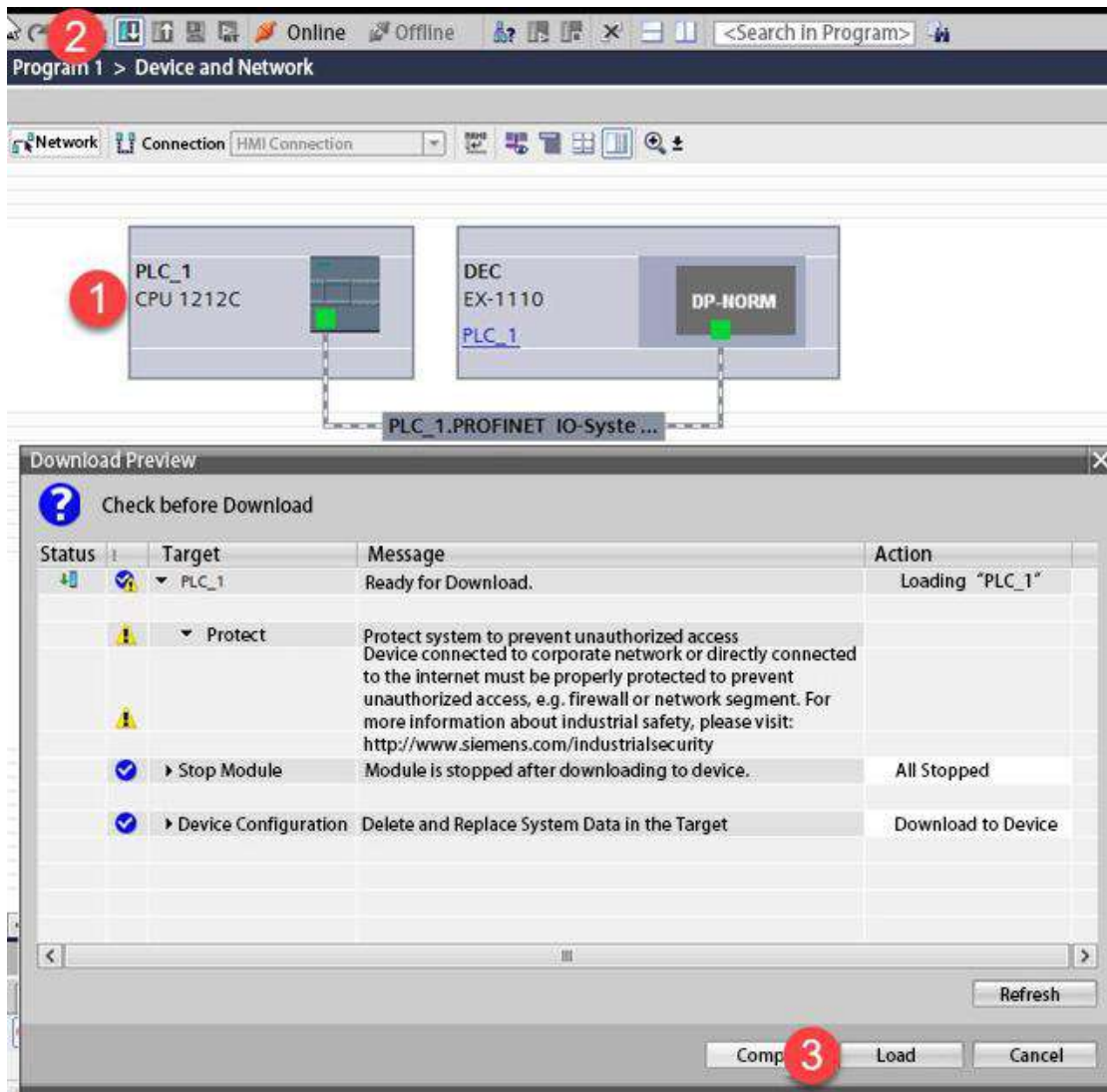

Figure 5-2-10 Program download

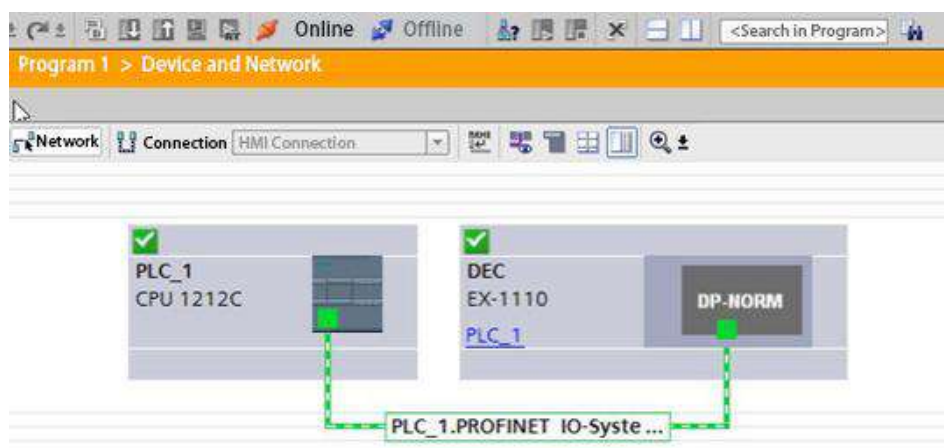

Figure 5-2-11 Device monitoring

5.2.2 Connection and Configuration between Step7 smart devices and EX-1110

1. Communication connection diagram, as shown in Figure 5-2-12.

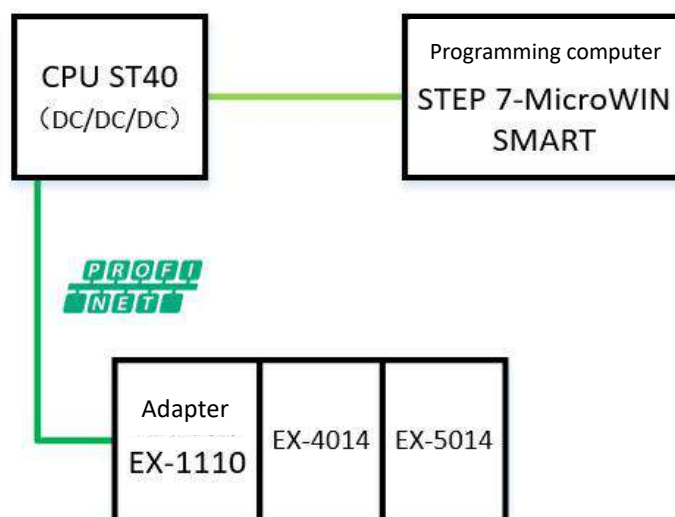

Figure 5-2-12 Communication connection diagram

2. Table 5-2-2 shows the hardware configuration

Table 5-2-2 Hardware configuration table

Hardware	Quantity	Note
Computer programming	1	Install STEP7 - MicroWIN SMART
The controller	1	CPU ST40(DC/DC/DC)
EX-1110	1	PROFINET adapter
EX-4014	1	Analog input module
EX-5014	1	Analog output module

Ethernet cable

A number of

3. Install the GSD file

Open Step7-Microwin SMART, and choose GSDML Management from the menu bar, as shown in Figure 5-2-13.

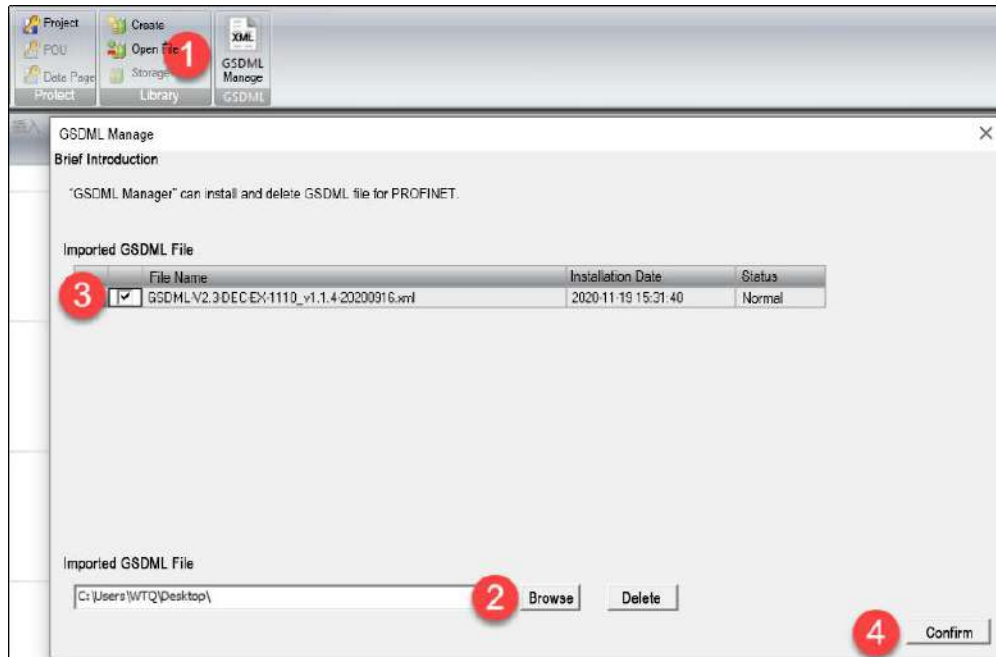

Figure 5-2-13 Installing GSD files

4. Assign the device name

On the menu bar, choose "Tools" > "Find PROFINET Device", select the network adapter connected to the module in the window and find the device, select the module in the network and edit its device name, as shown in Figure 5-2-14.

Note:

① When you select a NIC, two options are displayed for the same NIC, as shown in the following figure. Select the NIC without Auto.

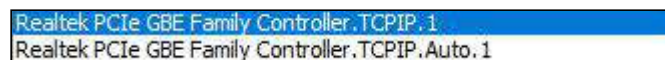

(2) After the device name is assigned, note that the device name must be the same as the assigned name when configuring the IO module; otherwise, PLC cannot communicate with the IO module normally.

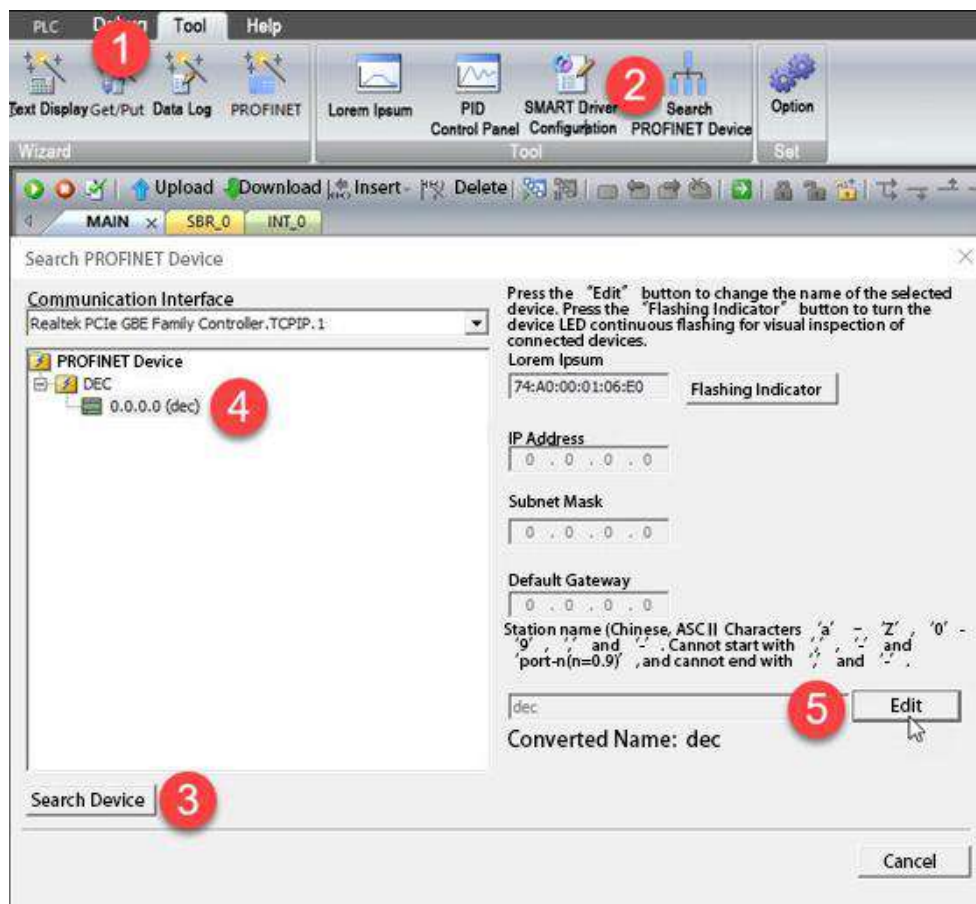

Figure 5-2-14 Assigning device names

5. New project and equipment configuration

On the menu bar, choose Tools > PROFINET, select the PLC role as the controller, as shown in Figure 5-2-15, add the adapter, assign the device name (the same as the device name assigned in Step 4 above) and IP address, as shown in Figure 5-2-16, add the IO module, as shown in Figure 5-2-17, and select Generate.

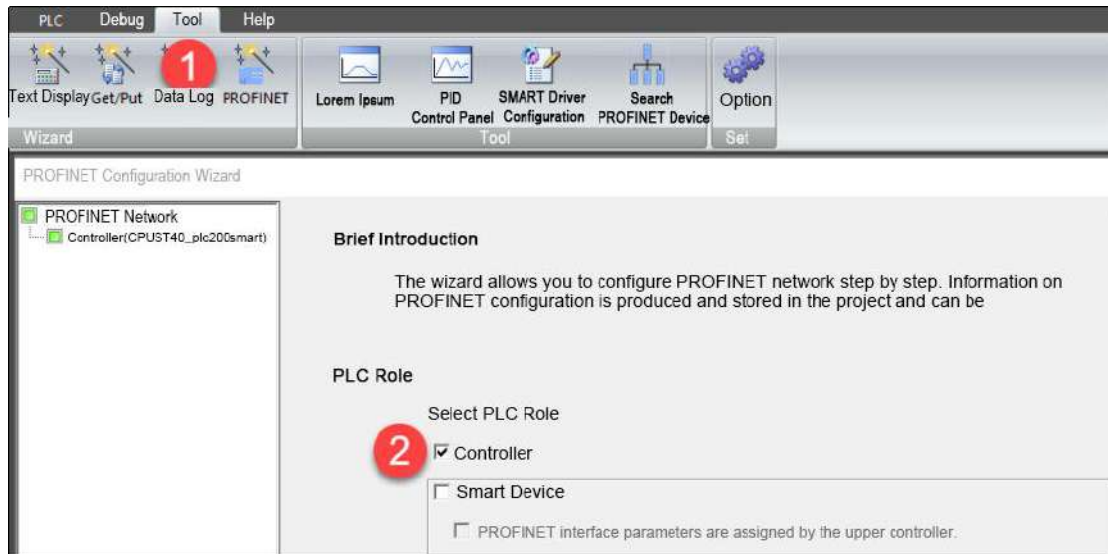

Figure 5-2-15 Selecting PLC roles

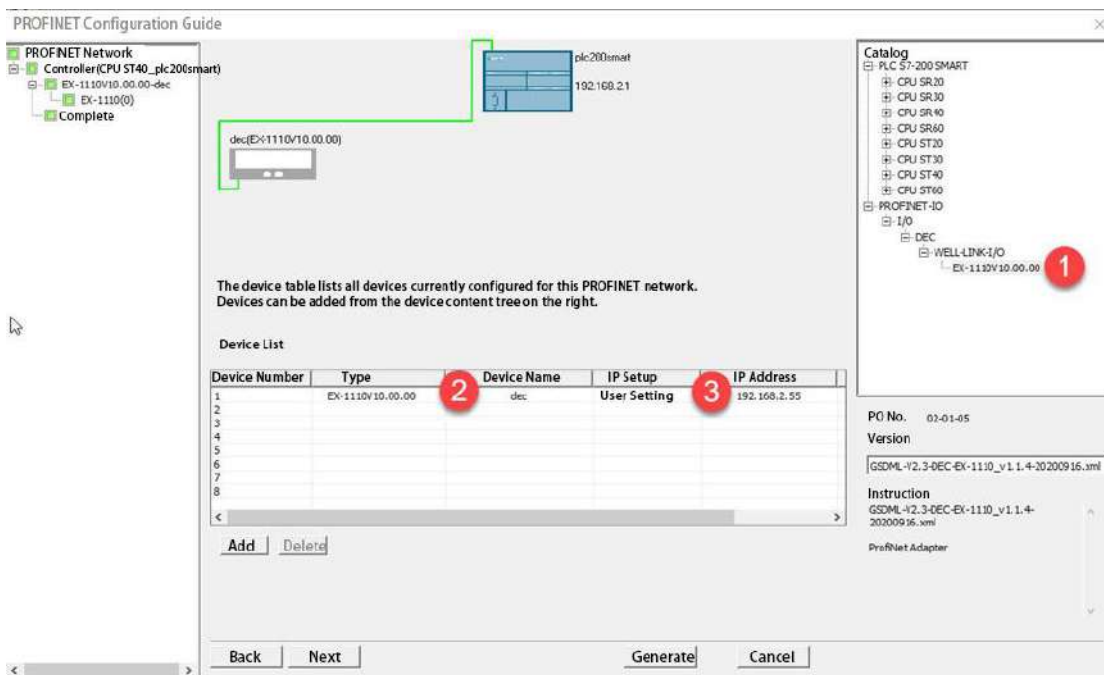

Figure 5-2-16 Adding an adapter

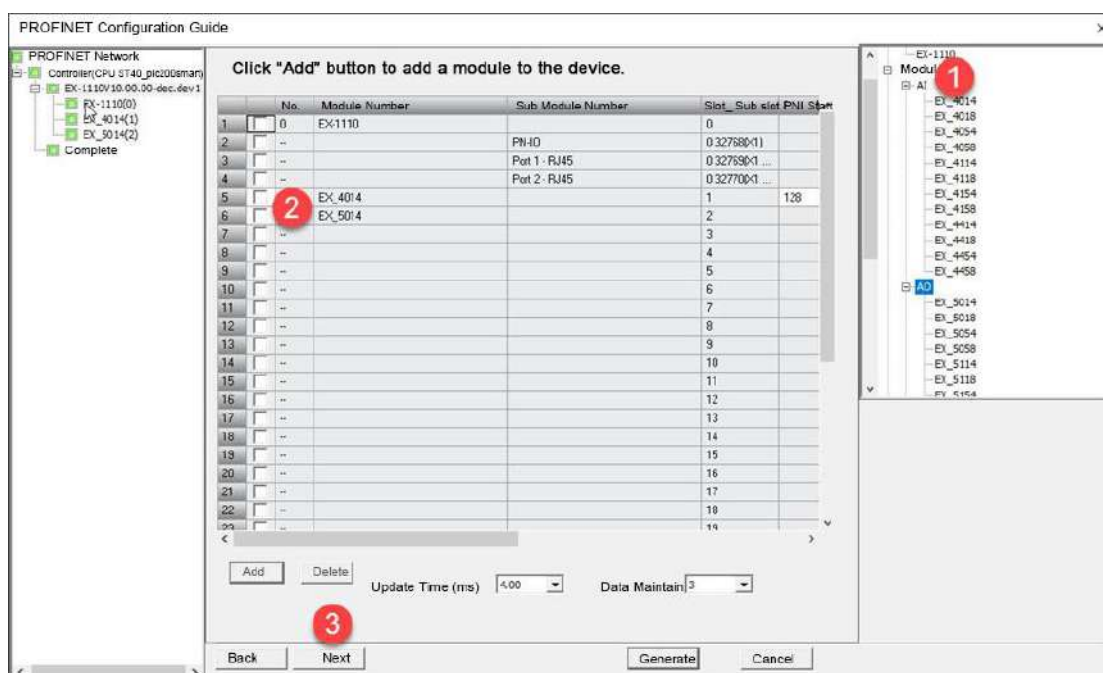

Figure 5-2-17 Adding I/O modules

6. Program download

Choose "PLC" > "Download" in the menu bar, and select "Find CPU" in the communication window, select the PLC that needs to download the program, and download the program.

Note: For PROFINET communication using STEP 7-Microwin SMART configuration 200 SMART, the CPU firmware version of PLC must be $\geq V2.4$. For firmware = V2.3, you can directly upgrade the firmware online. For firmware < 2.3, you must update the firmware with a memory card in the CPU.

5.2.3 Connection and Configuration between Step7 an Ex-1110

1. Communication connection diagram, as shown in Figure 5-2-18.

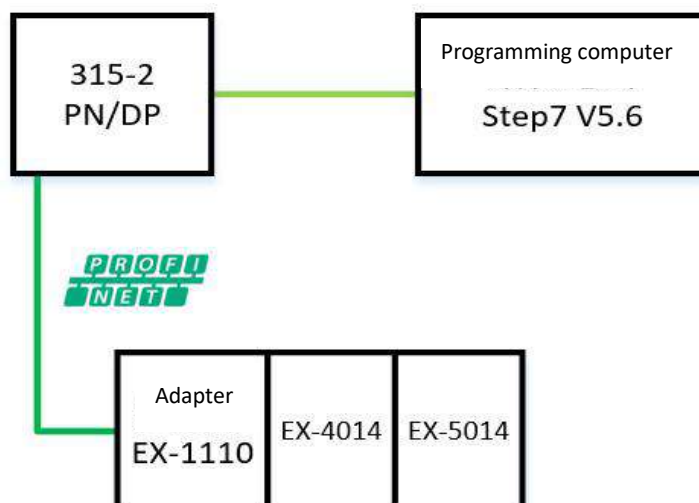

Figure 5-2-18 Communication connection diagram

2. Table 5-2-3 shows the hardware configuration

Table 5-2-3 Hardware configuration table

Hardware	Quantity	Note
Computer programming	1	Install Step7 V5.6
The controller	1	315-2 PN/DP
EX-1110	1	PROFINET adapter
EX-4014	1	Analog input module
EX-5014	1	Analog output module
Ethernet cable	A number of	

3. Install the GSD file

After the new project is created, click "SIMATIC300", double click "Hardware", in the HW Config window, choose "Options" > "Install GSD file" in the menu bar, as shown in Figure 5-2-19.

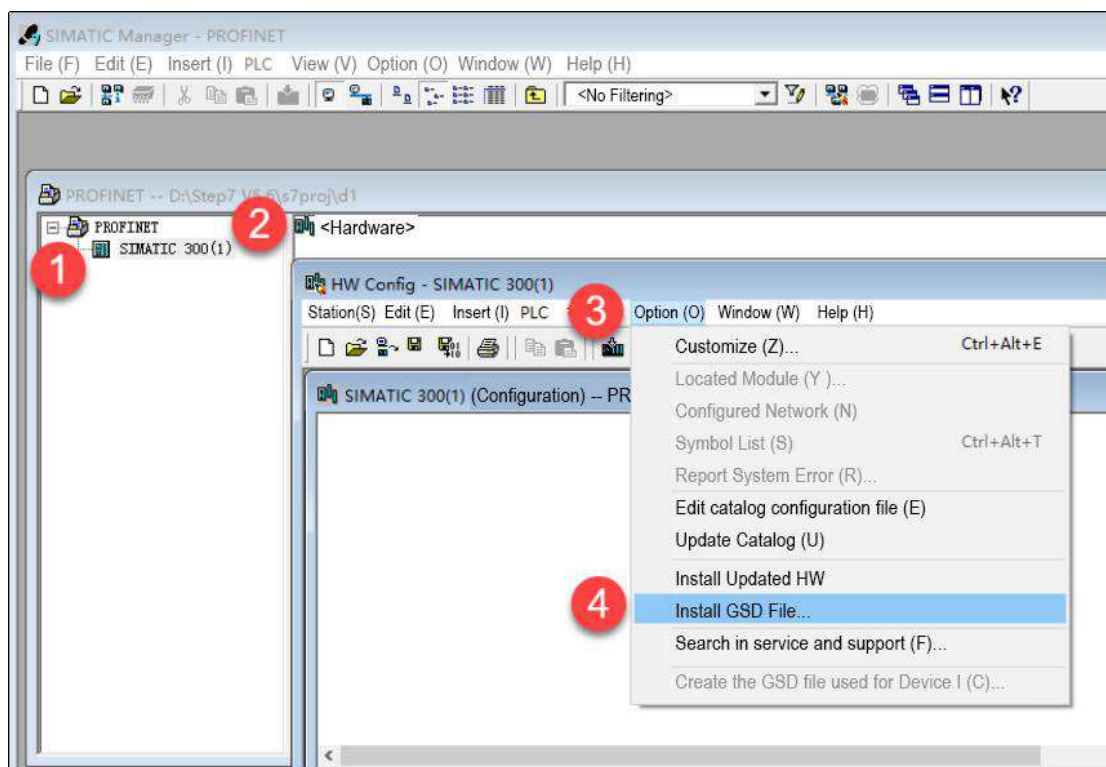

Figure 5-2-19 Installing GSD files

3. New project and equipment configuration

Open SIMATIC Manager, choose New Project from the menu bar, name the project, and select a path to save the project, as shown in Figure 5-2-20.

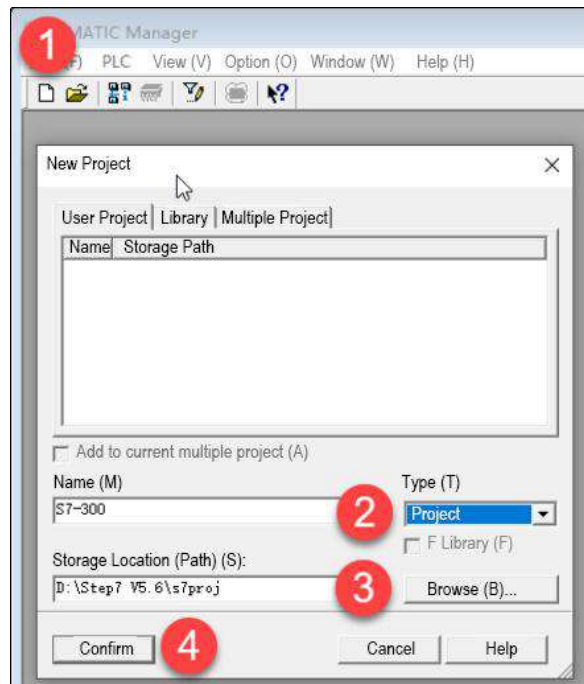

Figure 5-2-20 New construction project

Add 300 sites to the project, as shown in Figure 5-2-21. Click the newly added site 300 and select "Hardware" to enter the HW Config configuration interface, as shown in Figure 5-2-22. Add RACK Reil for RACK 300, as shown in Figure 5-2-23. To add a CPU module, click HW Config, select CPU315-2 PN/DP VERSION V2.6 of CPU-300 in the right pane, and drag the CPU module to slot 2 of the rack, as shown in Figure 5-2-24. In the Ethernet interface properties interface, you can use other IP addresses as required, here use the default IP address and subnet mask, and select the New button, create a new subnet Ethernet (1) click OK, as shown in Figure 5-2-25.

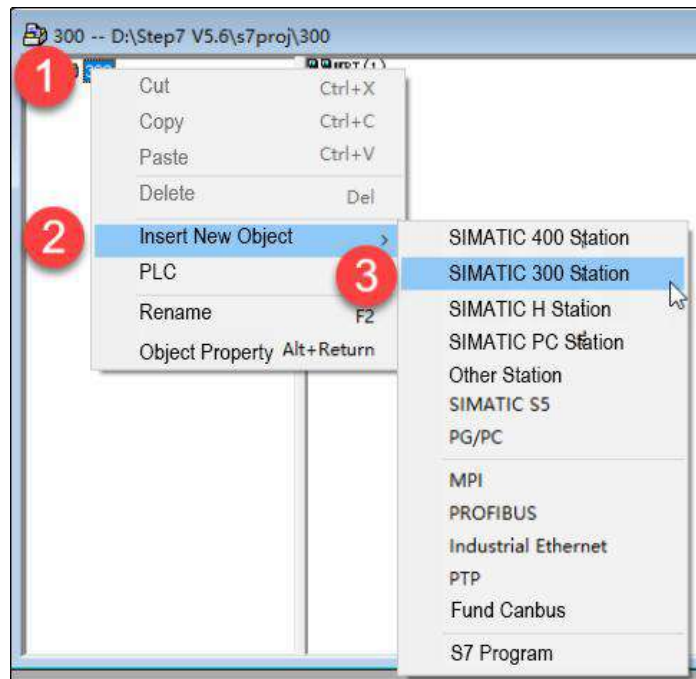

Figure 5-2-21 Adding 300 sites

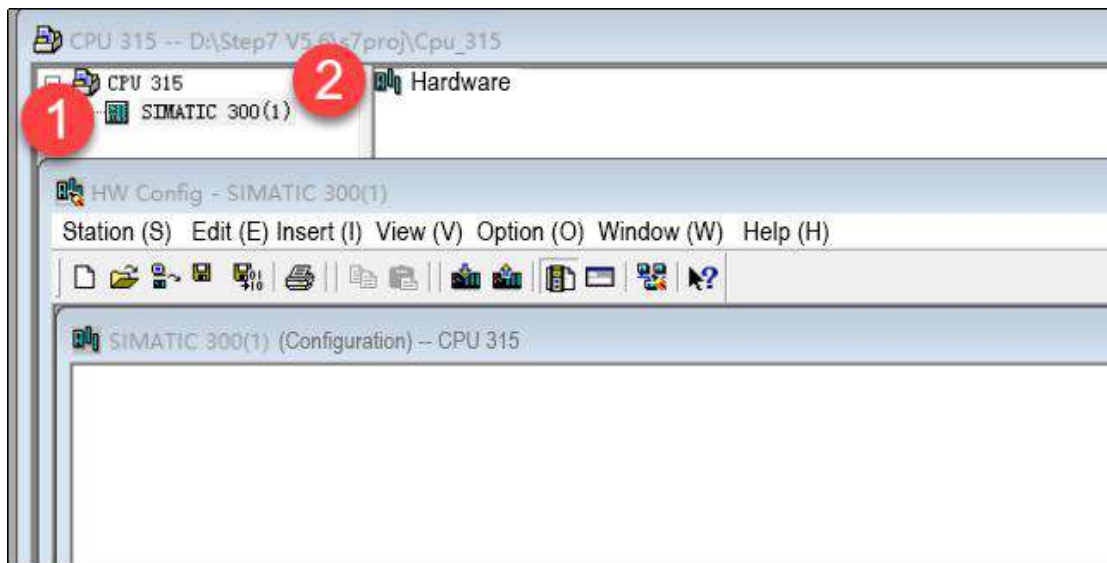

Figure 5-2-22 The HW Config page is displayed

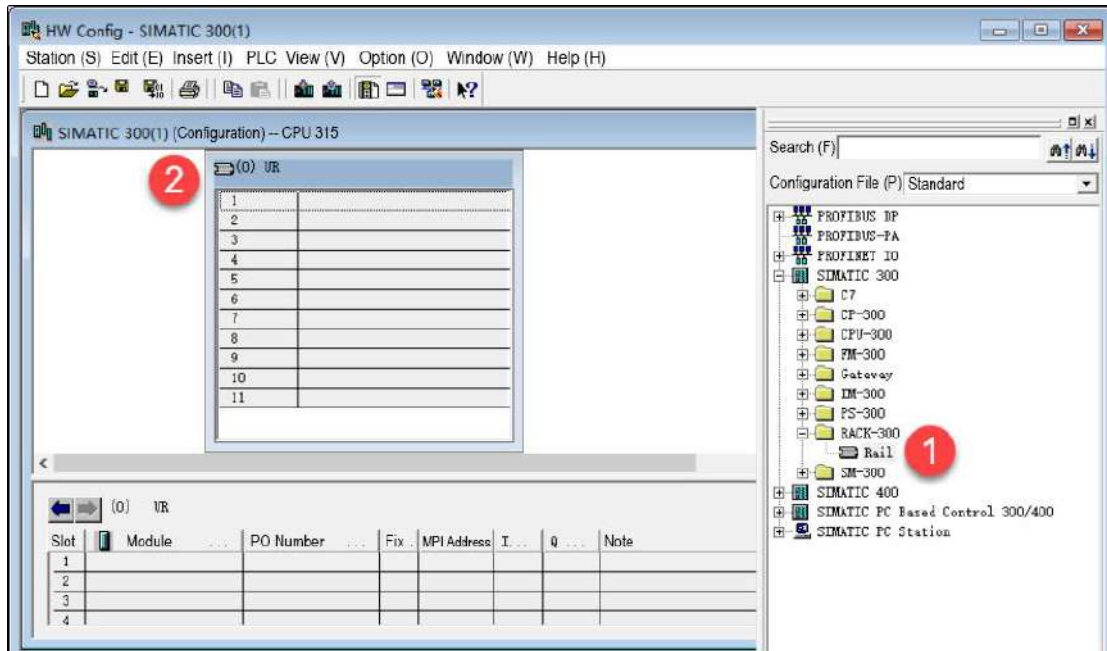

Figure 5-2-23 Adding rack Reil

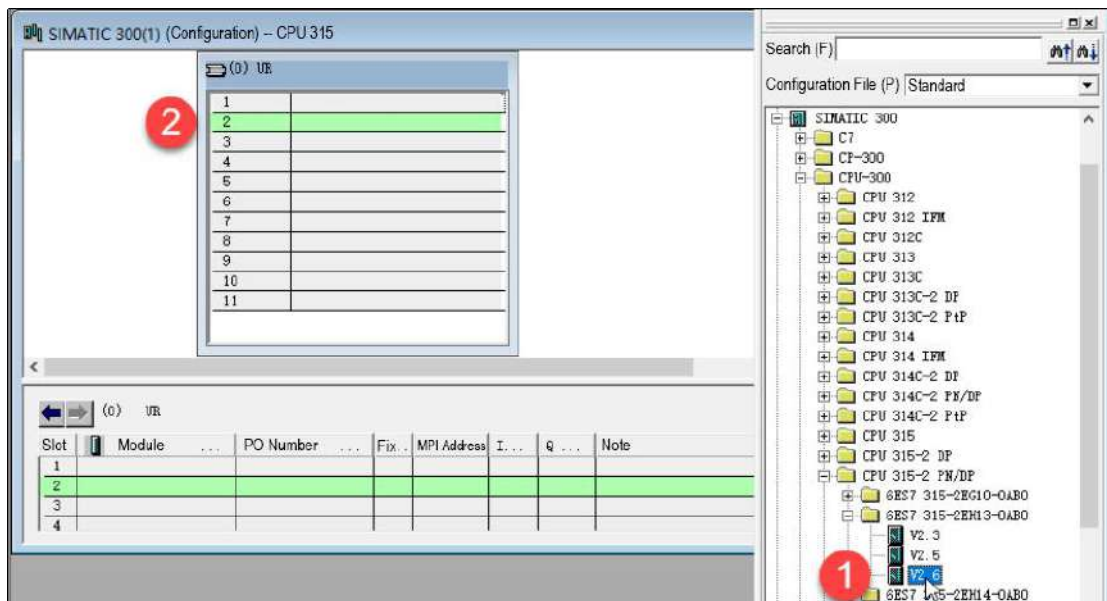

Figure 5-2-24 Adding a CPU module to the rack

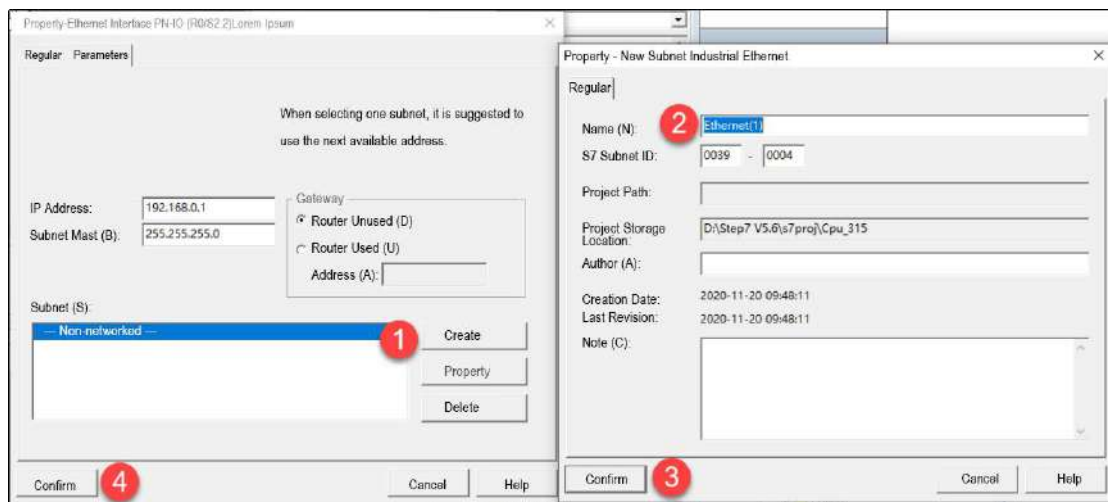

Figure 5-2-25 Adding an Ethernet subnet

On Ethernet (1), configure the I/O device station. On the right, select EX-1110 and drag it under the Ethernet (1) subnet, as shown in Figure 5-2-26.

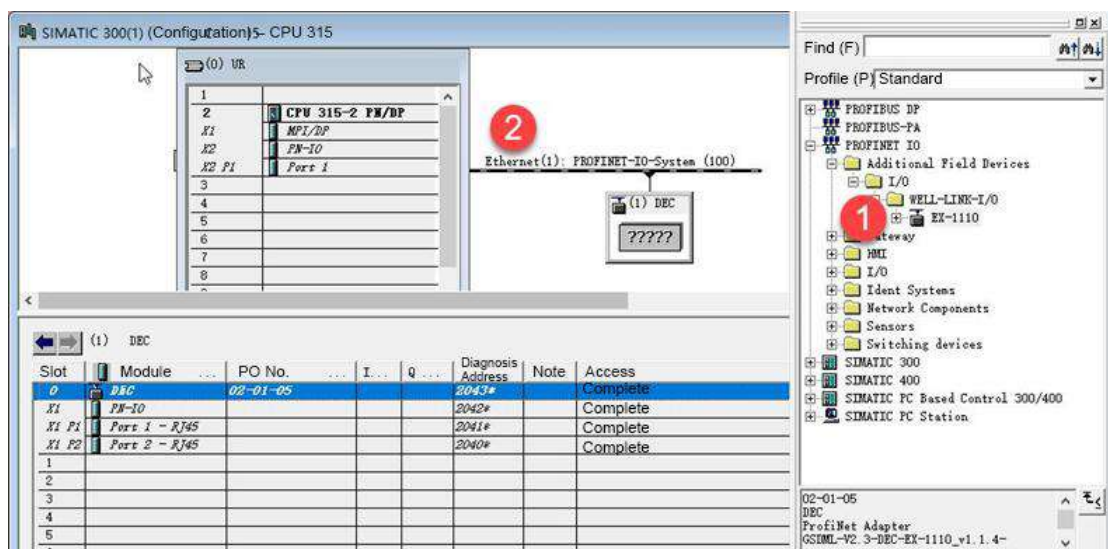

Figure 5-2-26 Adding IO to an Ethernet (1) subnet

Add an I/O module, expand the right EX-1110, and drag the EX-4014 and EX-5014 to the lower slot on the left, as shown in Figure 5-2-27.

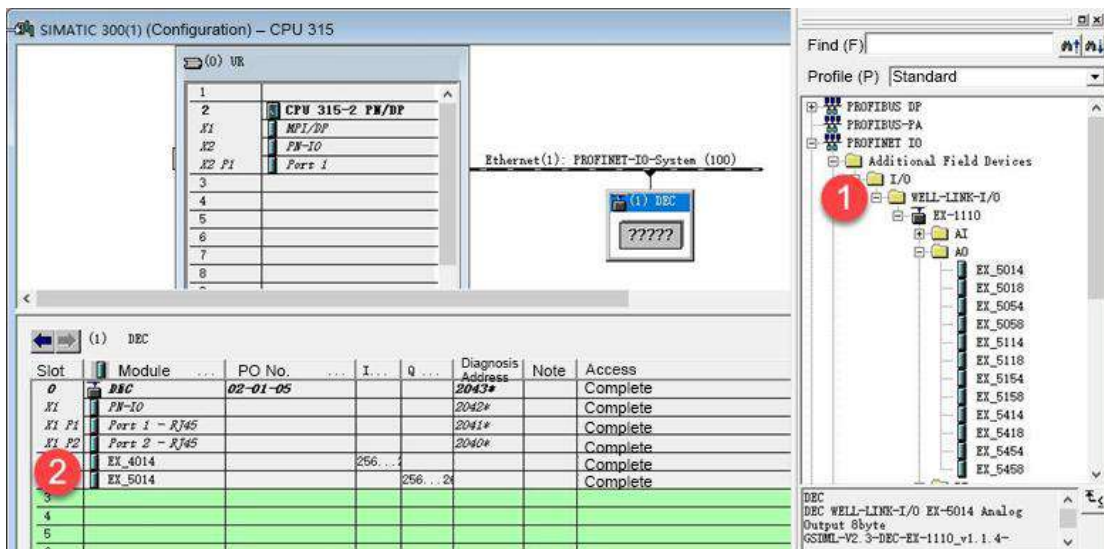

Figure 5-2-27 Adding an I/O module

To change the IP address of the I/O device station, double-click the DEC module in the subnet and choose Ethernet in the Properties window. You can change the IP address in the Ethernet properties window, as shown in Figure 5-2-28.

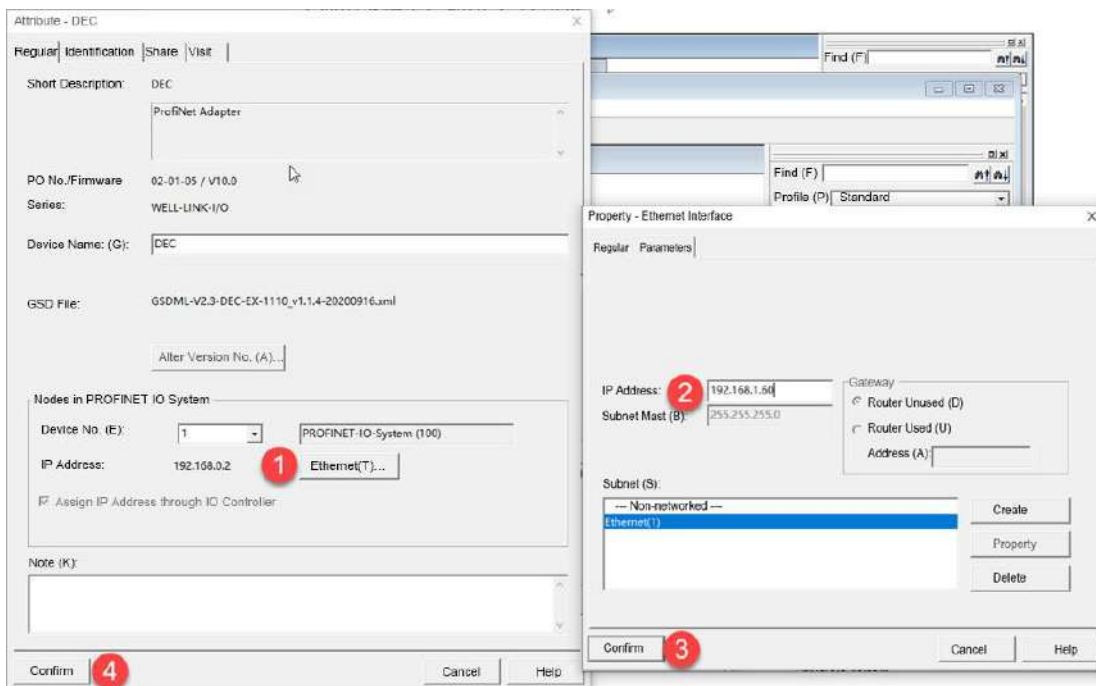

Figure 5-2-28 Changing the MODULE IP address

Set the device name for the I/O module, select the subnet icon, choose PLC on the menu bar, Ethernet > Assign Device Name, as shown in Figure 5-2-29. In the Assign Device name window, select the name to assign, and press Ok.

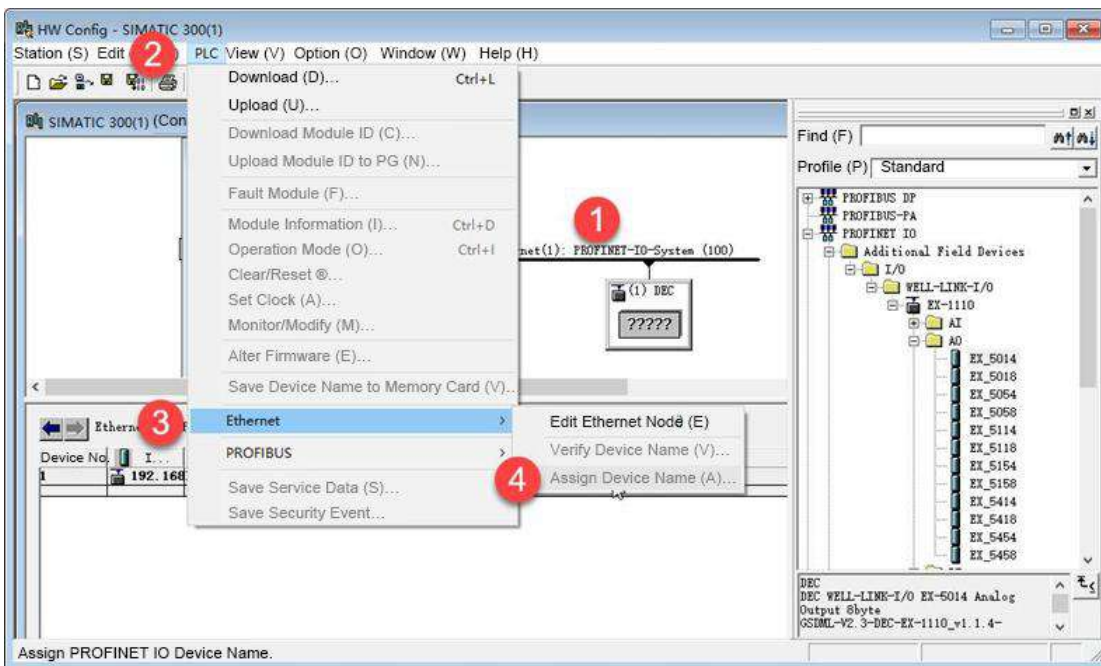

Figure 5-2-29 Assigning device names

To check whether the name is assigned successfully, select the subnet icon, choose PLC on the menu bar, and Ethernet > Verify Device Name, as shown in Figure 5-2-30.

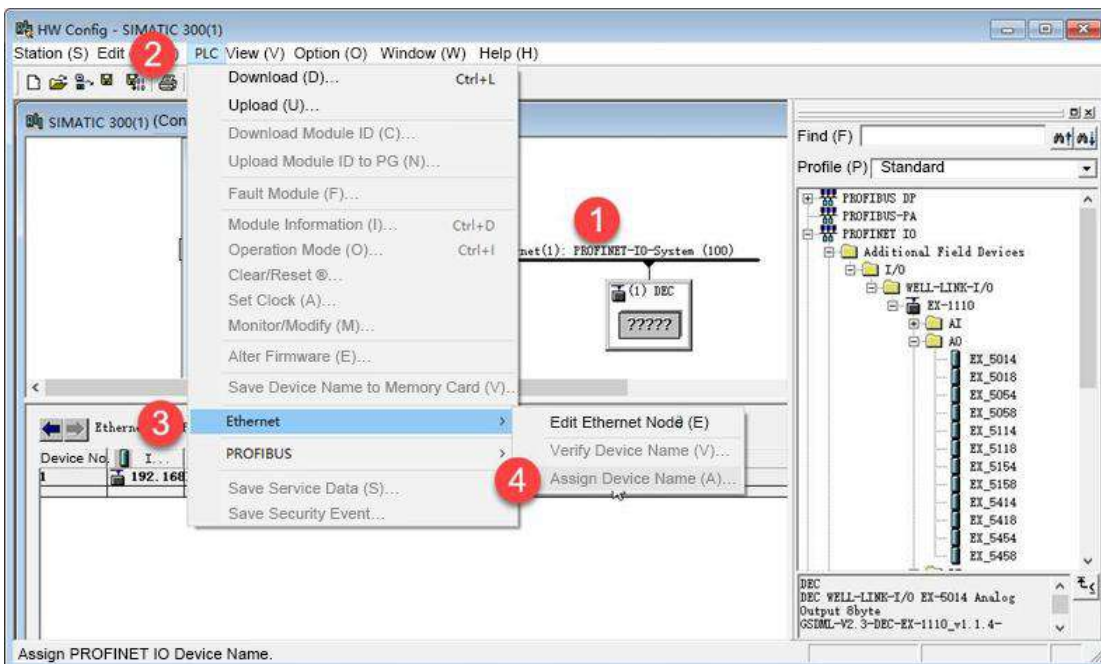

Figure 5-2-30 Verifying the device name

5.2.4 Connection and configuration between CODESYS and EX-1110

1. Communication connection diagram, as shown in Figure 5-2-31.

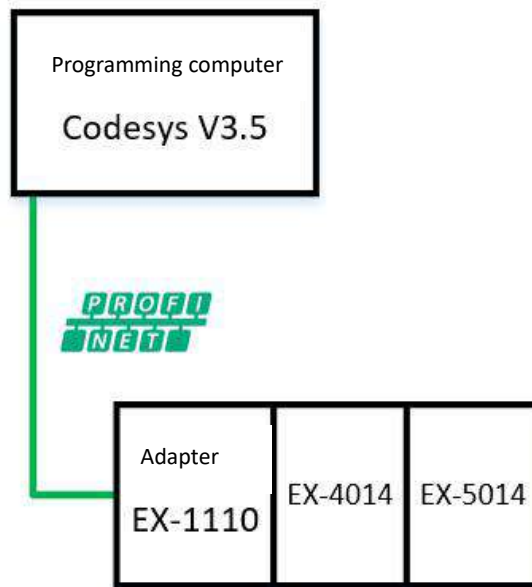

Figure 5-2-31 Communication connection diagram.

2. Table 5-2-4 shows the hardware configuration

Table 5-2-4 Hardware configuration table

Hardware	Quantity	Note
Computer programming	1	Install the Codesys V3.5
EX-1110	1	PROFINET adapter
EX-4014	1	Analog input module
EX-5014	1	Analog output module
Ethernet cable	A number of	

2. Install the GSD file

Open CODESYS V3.5 and choose Tools > Device Repository from the menu bar, as shown in Figure 5-2-32.

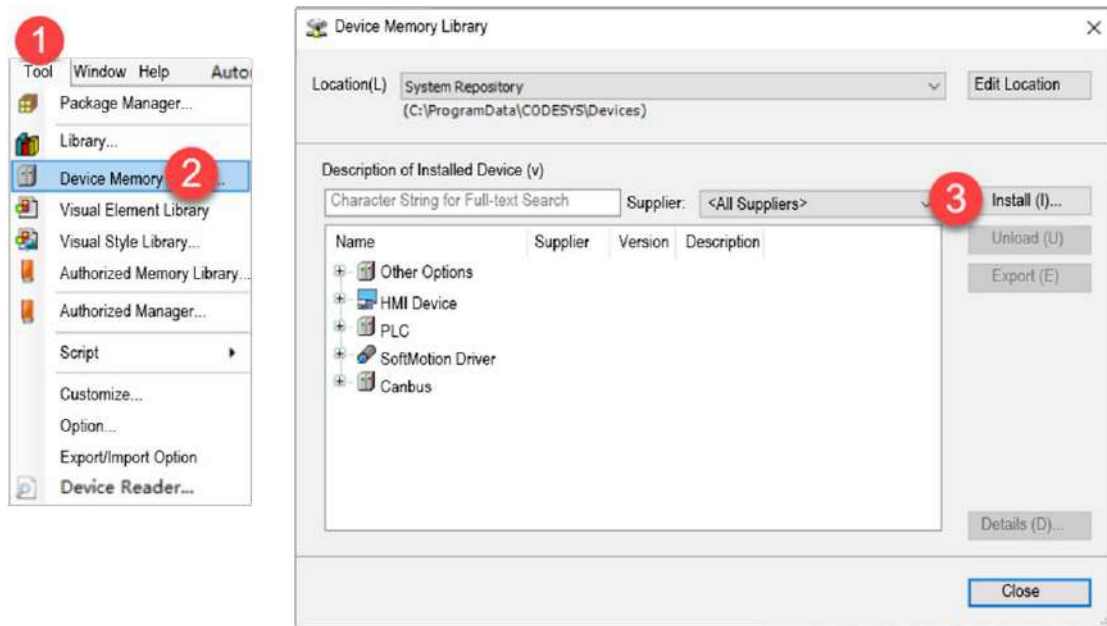

Figure 5-2-32 Installing GSD files

4. New project and equipment configuration

Open CODESYS V3.5 software and choose "New Project" > "Project" > "Standard Project", as shown in Figure 5-2-33.

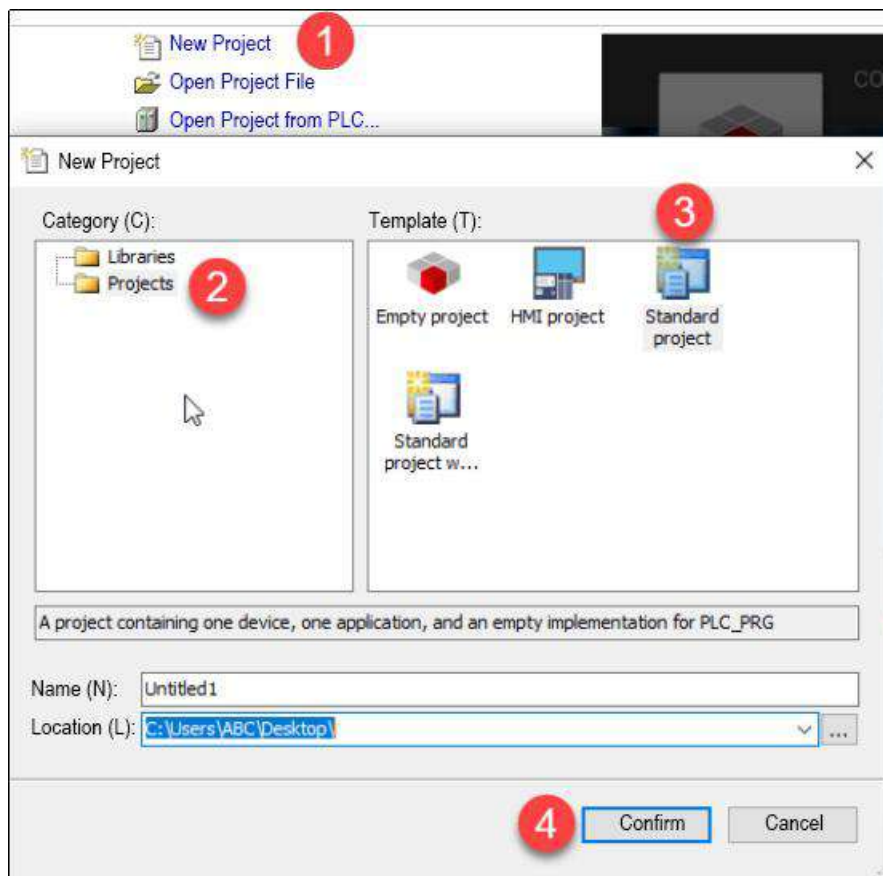

Figure 5-2-33 New construction project

In the standard engineering window, select CODESYS SoftMotion Win V3 for device and Structured Text (ST) for PLC_PRG programming language, as shown in Figure 5-2-34.

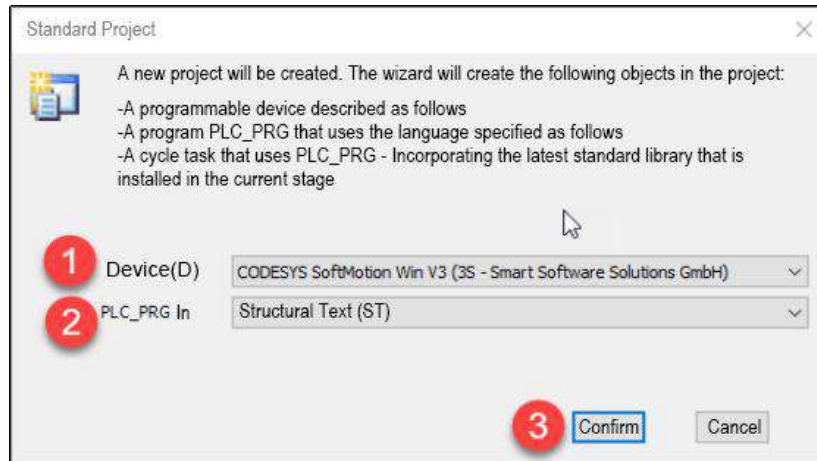

Figure 5-2-34 Selecting device and programming language

Choose Device (CODESYS SoftMotion Win V3) > Add Device in the Device tree to add the Ethernet adapter and PROFINET IO master station, as shown in Figure 5-2-35 and 5-2-36.

Tip: PROFINET IO configuration in the original Codesys software, if an error is reported that the library is lost, the user needs to manually double click the library manager and choose to download the lost library in the library manager window. This process requires the computer to connect to the network. In addition, pay attention to the IP address and network segment of the network port connected to the I/O device. Otherwise, the IP address of the I/O device may be in different network segments.

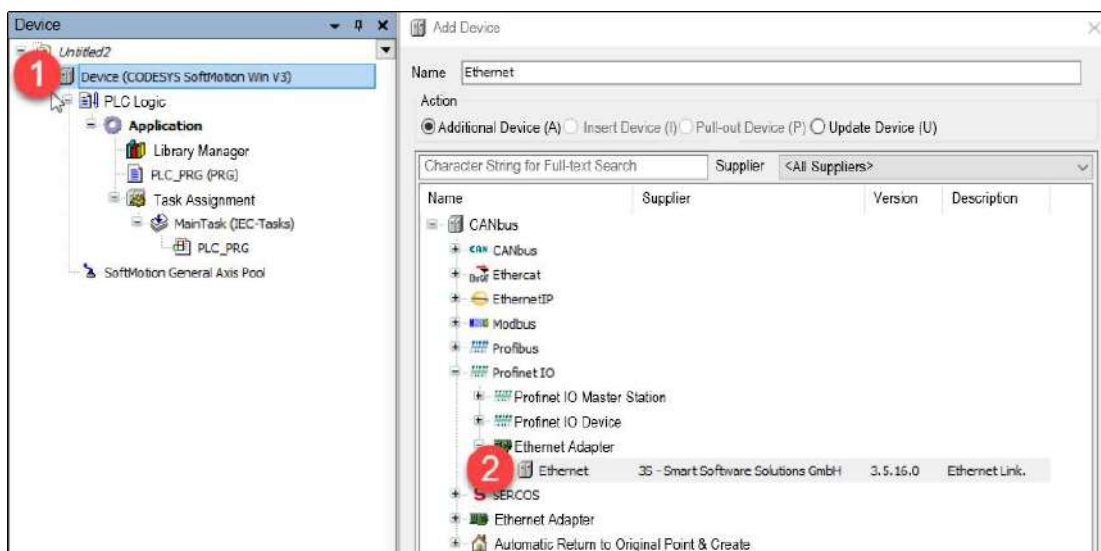

Figure 5-2-35 Adding an Ethernet adapter



Figure 5-2-36 Adding PROFINET IO master station

Double-click Ethernet in the device tree to assign Ethernet ports and set IP parameters for the PROFINET IO master station, as shown in Figure 5-2-37 and 5-2-38.

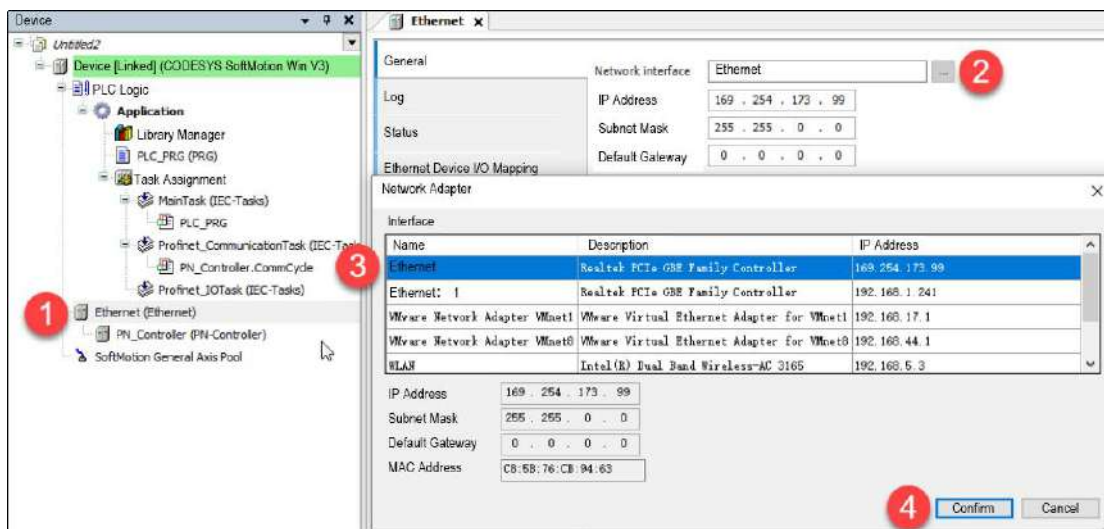

Figure 5-2-37 Ethernet distribution network ports

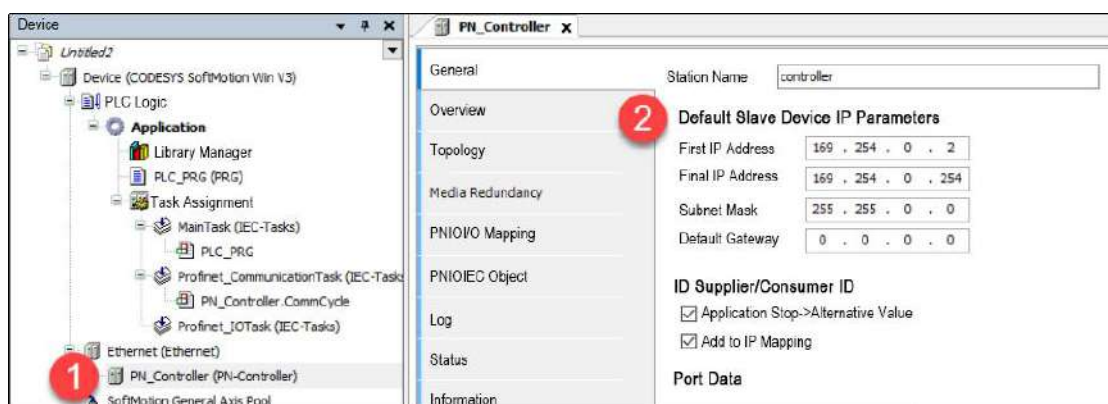

Figure 5-2-38 Setting the PROFINET IO master IP address

Download the program to the controller and start running, and then log out. Right-click PN_Controller and choose Scan Devices. In the device window, select the module and assign the device name and IP address, as shown in Figure 5-2-39. Copy the device into the project, as shown in Figure 5-2-40.

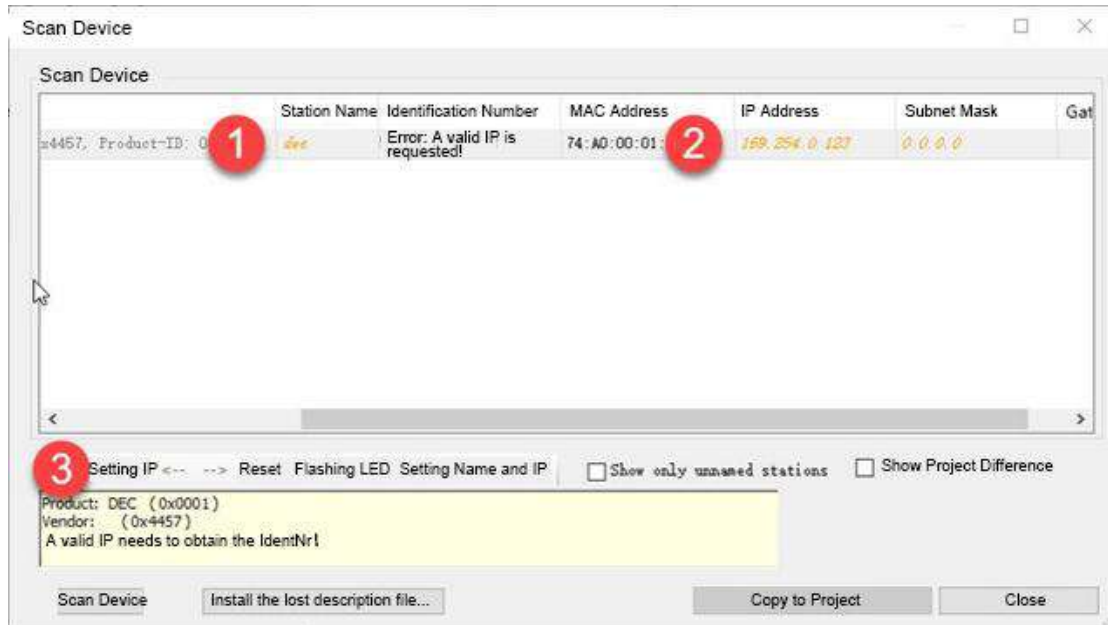

Figure 5-2-39 Assigning names and IP addresses

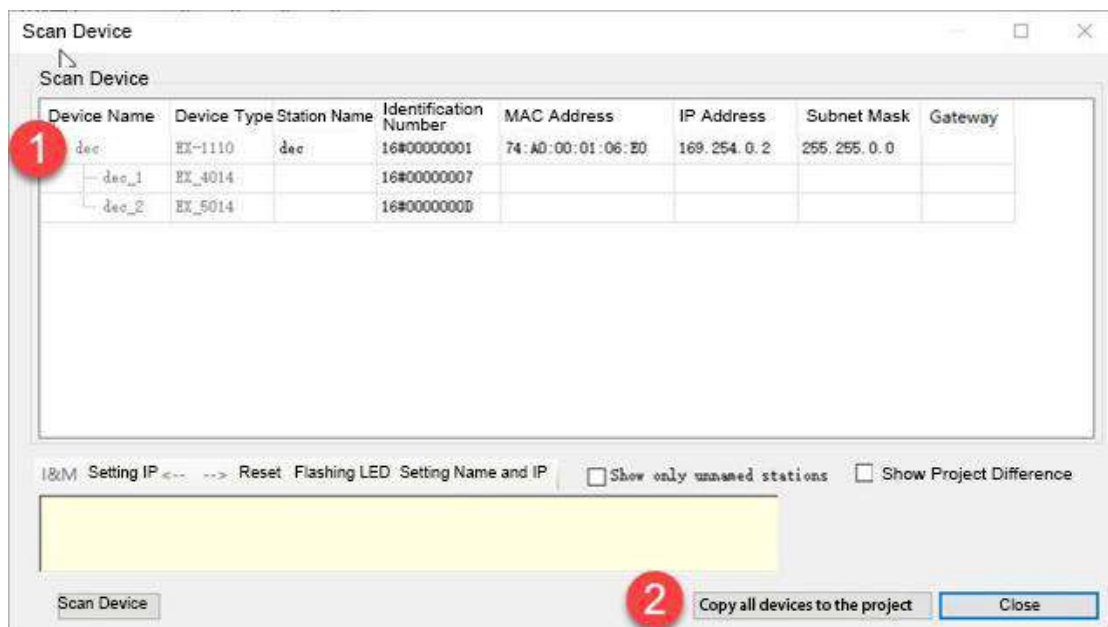

Figure 5-2-40 Copying equipment into project

5. Program download and equipment monitoring

Download the project to the controller and start the operation and monitoring, as shown in Figure 5-2-41.

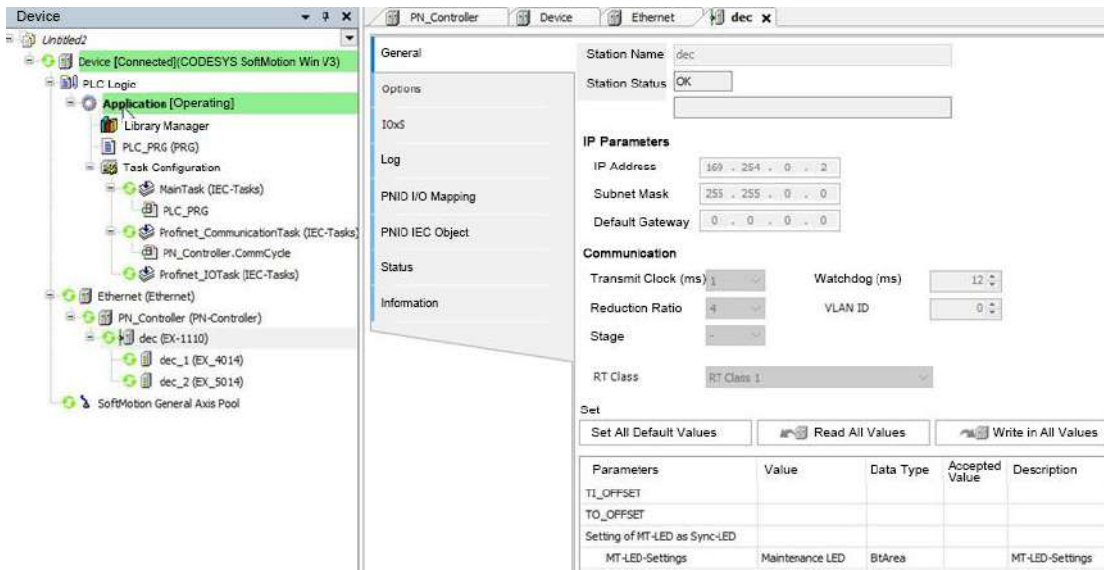

Figure 5-2-41 Program download and monitoring

5.3 Connection between EX-1010 and PLC

Note: cX-One and EX-1010 have manual and automatic communication configurations. Please refer to details 4 and 5 in 5.3.1 for details.

5.3.1 Connection and Configuration between CX-One and EX-1010

1. Communication connection diagram, as shown in FIG. 5-3-1.

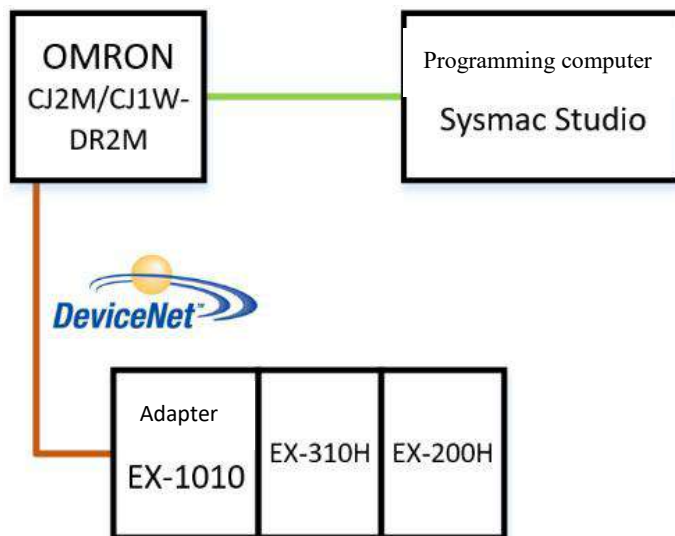

Figure 5-3-1 Communication connection diagram

Note: The power interface above the DeviceNet adapter needs to be separately connected to DC24V power supply. Terminal resistors (121 ω) need to be added to the two terminals in the network, as shown in Figure 5-3-2.

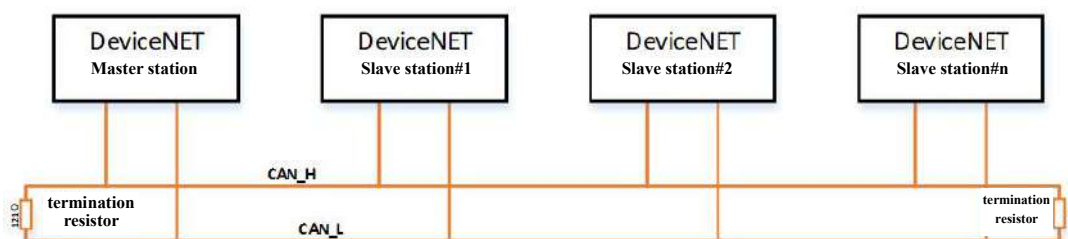

Figure 5-3-2 Terminal resistance wiring

2. Hardware configuration is shown in Table 5-3-1

Table 5-3-1 Hardware configuration table

Hardware	Quantity	Note
Computer programming	1	CX-one
The controller	1	CJ2M/ CJ1W-DR2M

EX-1010	1	DeviceNet adapter
EX-200H	1	Digital quantity input module
EX-310H	1	Digital output module
DeviceNet communications line	A number of	

3. Install the EDS file

Open cX-Integrator configuration software, and choose Tools > DeviceNet Tools > Edit Configuration File > Vendor ID/ Device Type Table from the menu bar, as shown in Figure 5-3-2.

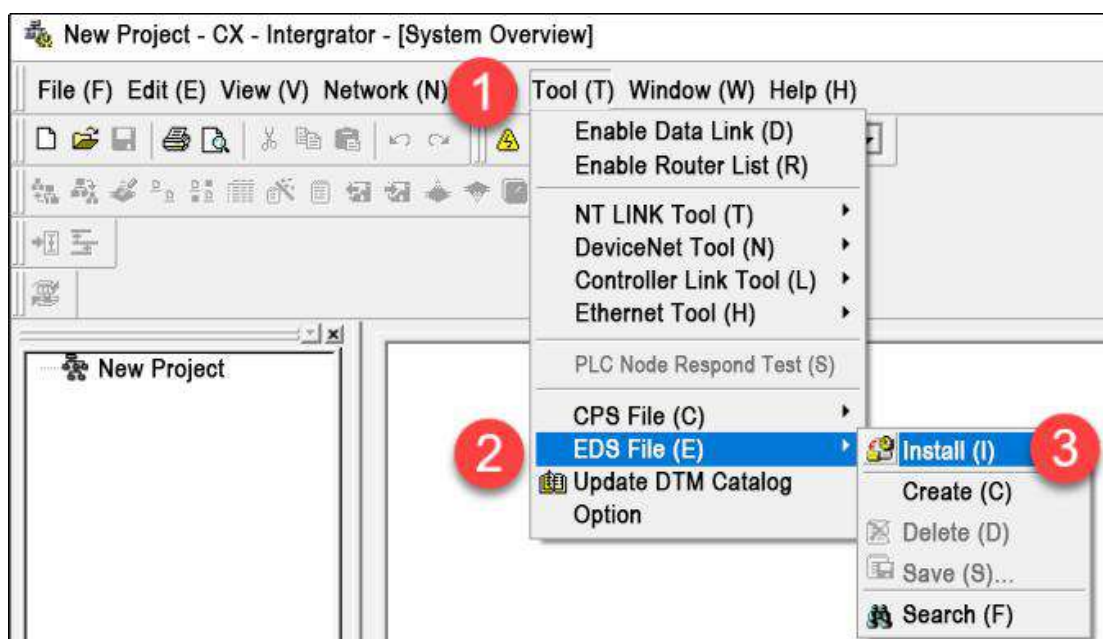

Figure 5-3-2 Installing the EDS file

4. Equipment configuration (automatic scanning)

Open CX-Integrator configuration software, choose "Network" > "Communication Settings" from the menu bar, and select THE PLC model as "CJ2M (CPU model: CPU31)", as shown in Figure 5-3-3.

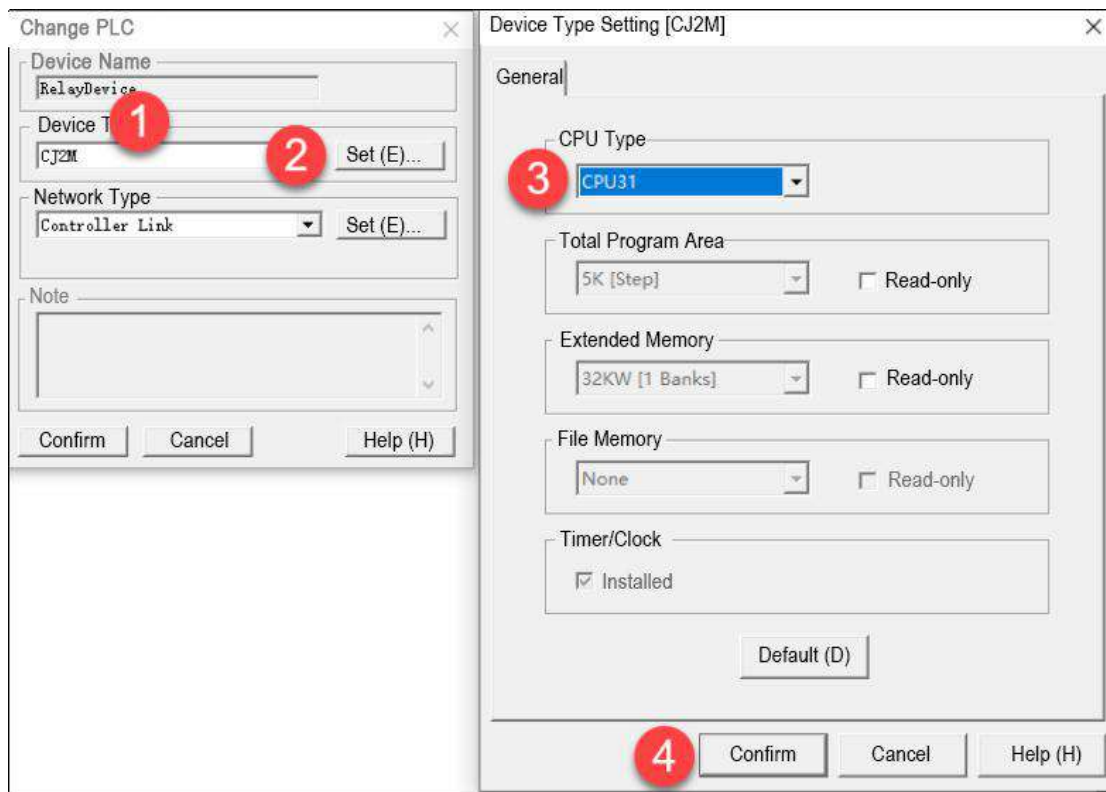

Figure 5-3-3 Configuring the CPU

Automatic scanning, click "Online Work button", double-click DeviceNet[CJ1W-DRM21] network (-), node (1), unit (0), and set the network name, confirm transmission, as shown in Figure 5-3-4. Double-click ex-102 to see if OMron PLC scans to ex-1020 slave station and IO module.

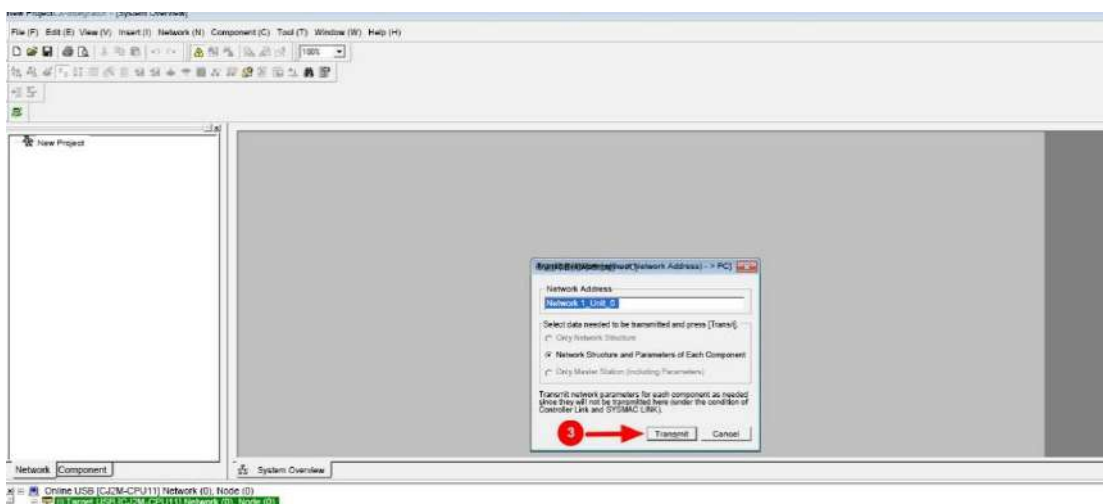

Figure 5-3-4 Automatic scanning

Right-click to scan the EX-1010 icon, choose Properties, choose I/O Info > Edit, and configure the number of input/output bytes for the adapter according to the input/output bytes size, as shown in Figure 5-3-5.

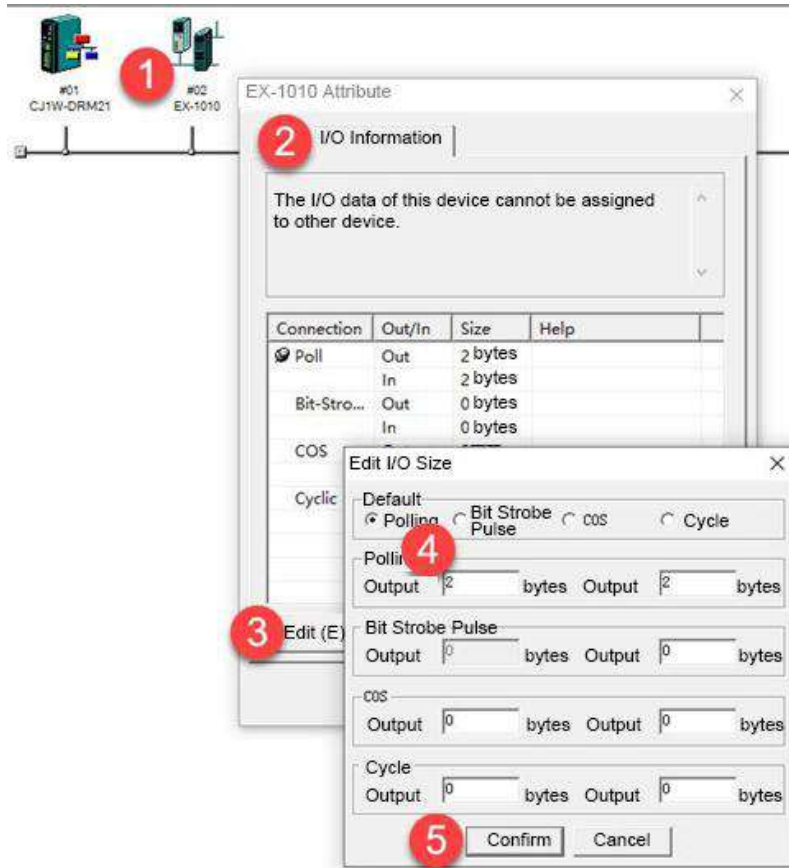

Figure 5-3-5 Edit the input and output bytes

5. Equipment configuration (manual configuration)

"New Project" on the right, select "Plug in Network" and "DeviceNet", as shown in Figure 5-3-6.

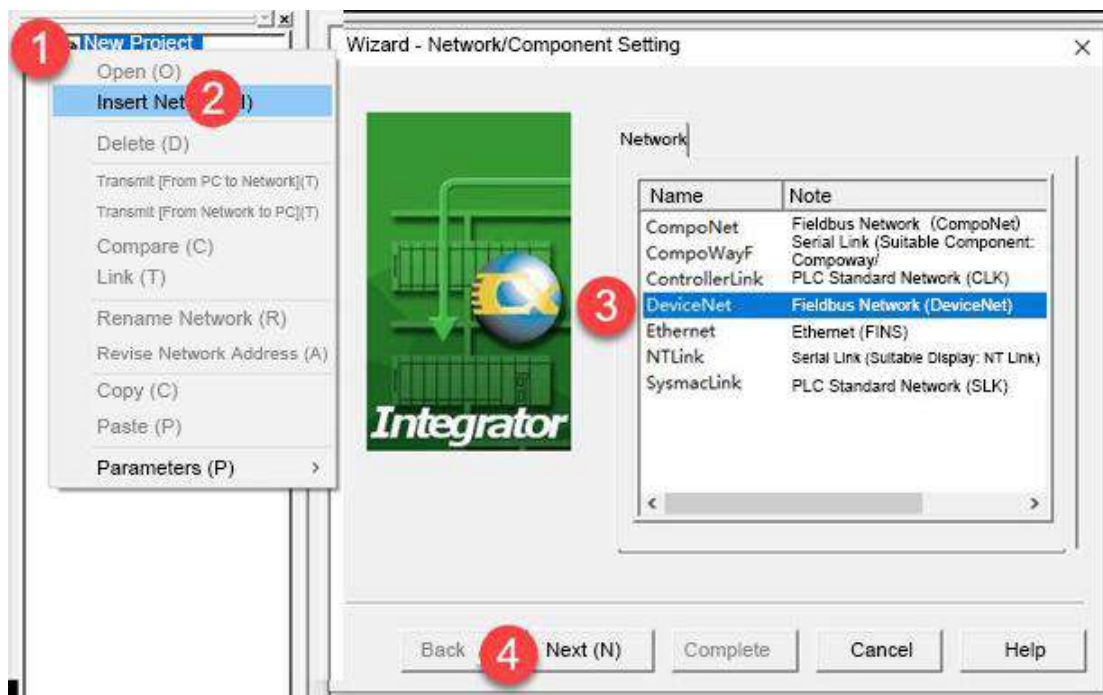

Figure 5-3-6 inserting into the network

Add the DeviveNet communication module CJ1W-DRM21 and then add the IO device. Right-click the network icon and choose Insert Component. In the wizard window, select EX-1010, as shown in Figure 5-3-7.

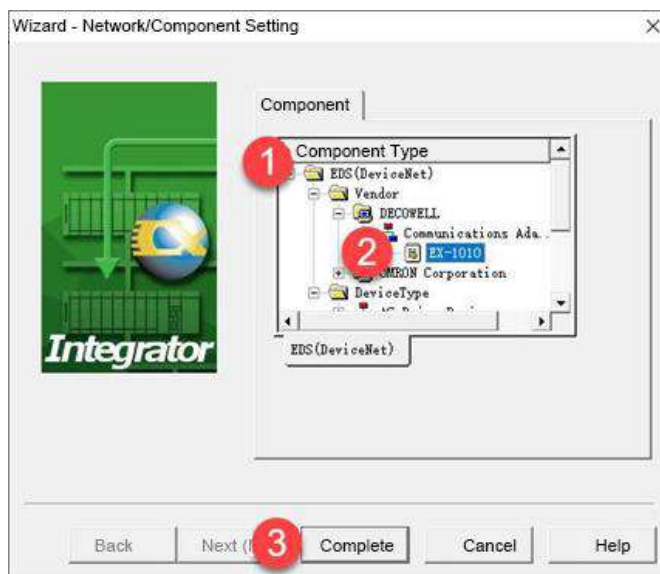

Figure 5-3-7 Insert ex-1010

On the network, double-click EX-1010, and add the I/O module (for example, EX-310H and EX-200H) in the edit device parameter window that is displayed, as shown in Figure 5-3-8.

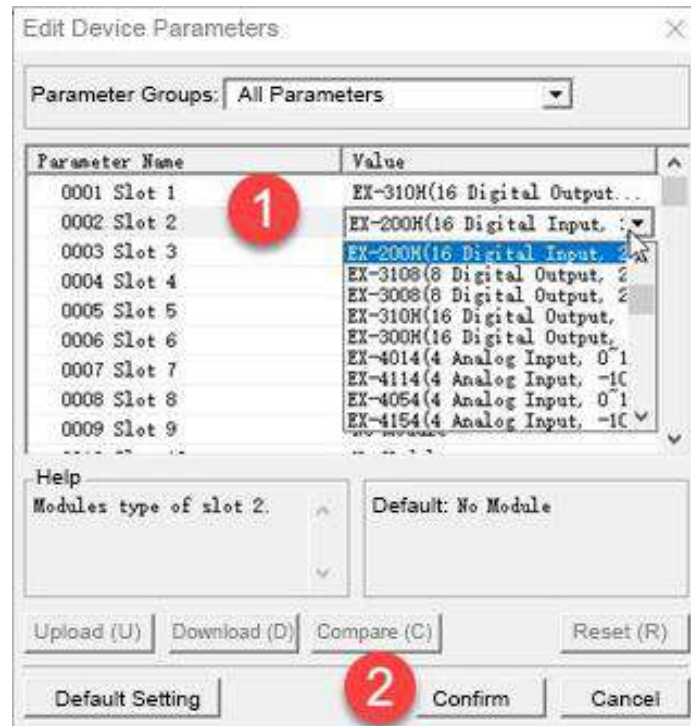

Figure 5-3-8 Adding an IO module

Right-click EX-1010 on the network and choose Properties. In the EX-1010 properties window, choose I/O Info > Edit, as shown in Figure 5-3-9.

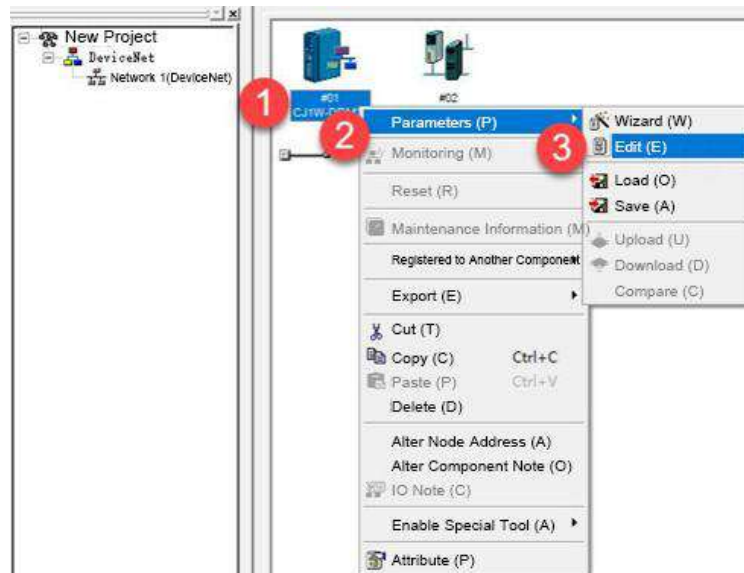

Figure 5-3-9 Edit the size of input and output bytes

6. Download configuration information

Right-click the CJ1W-DR2m icon and choose Parameters > Edit, as shown in Figure 5-3-10.

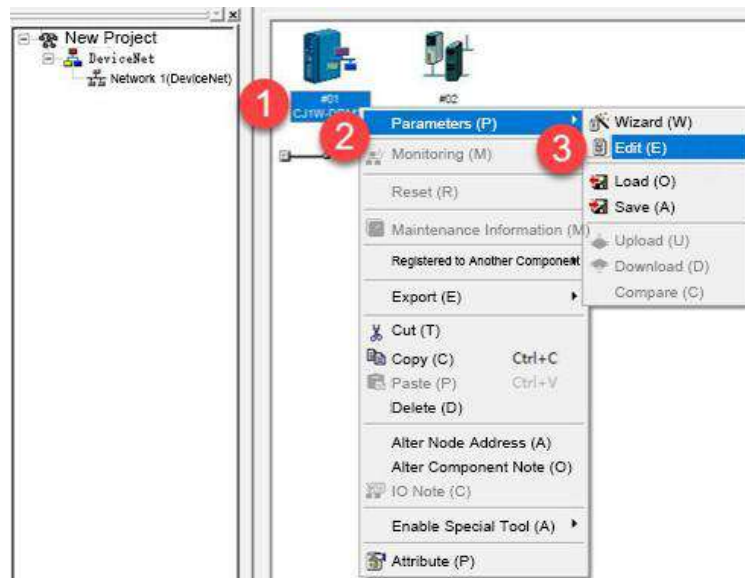

Figure 5-3-10 Opening parameter editing

In the edit device parameter window, select "Register button" to register the slave device, as shown in Figure 5-3-11. After successful registration, you can see the PLC internal address corresponding to the input and output of the slave I/O module. Finally, click the "Download" button to download the configuration information to PLC, as shown in Figure 5-3-12. After downloading, you can observe that the NET RUN indicator on the adapter lights up and the SYS indicator flashes once per second.

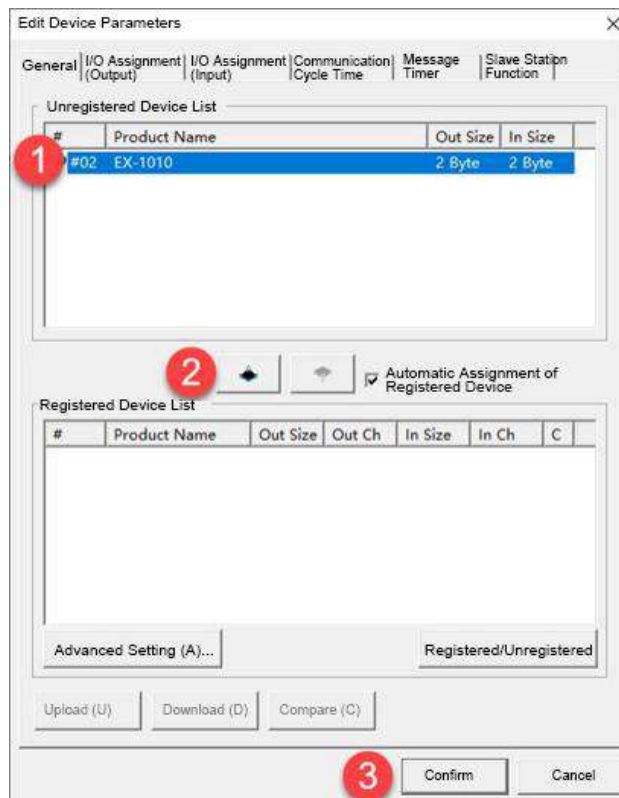

Figure 5-3-11 Slave device registration

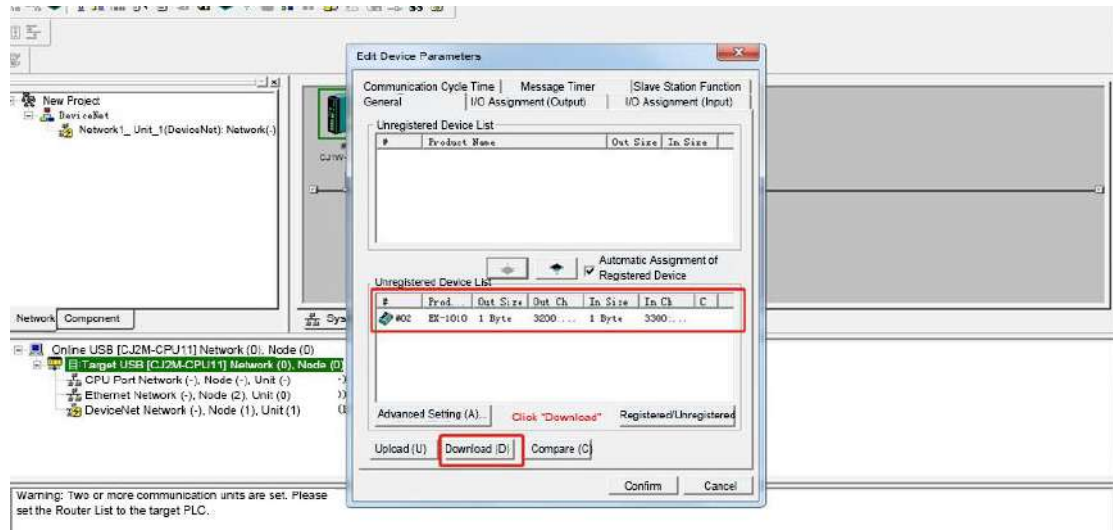

Figure 5-3-12 Download configuration

5.4 Connection and configuration between Codesys and EX-1130

5.5 Connection between EX-1040 and PLC

5.5.1 Connection and Configuration between GX-WORKS2 and EX-1040

1. Communication connection diagram, as shown in Figure 5-5-1.

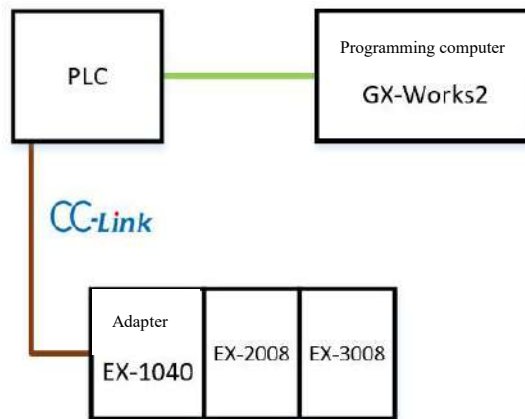

Figure 5-5-1 Communication connection diagram

Note: Add terminal resistors (110 Ω) to the two terminals in the network, as shown in Figure 5-5-2 below.

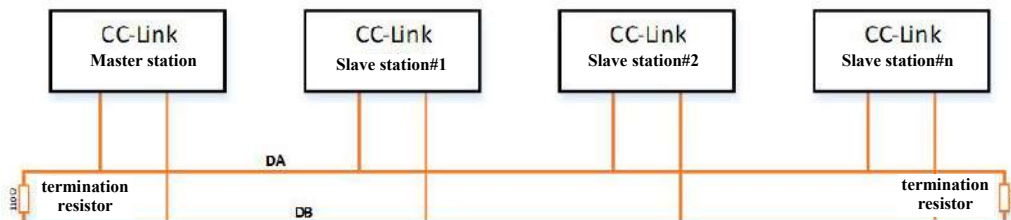

Figure 5-5-2 Terminal resistance cable connection

2. Table 5-5-1 shows the hardware configuration

Table 5-5-1 Hardware configuration table

Hardware	Quantity	Note
Computer programming	1	Install the GX Works2. -
PLC	1	Supports CC-link
EX-1040	1	CC - Link adapters
EX-2008	1	Digital quantity input module
EX-3008	1	Digital output module
CC - Link communication lines	A number of	

3. New project and communication parameter configuration

Open gX-WorkS2 software, select the actual site CPU model, and then choose Parameter > Network Parameter > CC-Link in the left navigation bar of the project. In the CC-Link parameter setting window, set the PARAMETERS of CC-Link slave station, as shown in Figure 5-5-3. As shown in Figure 5-5-4.

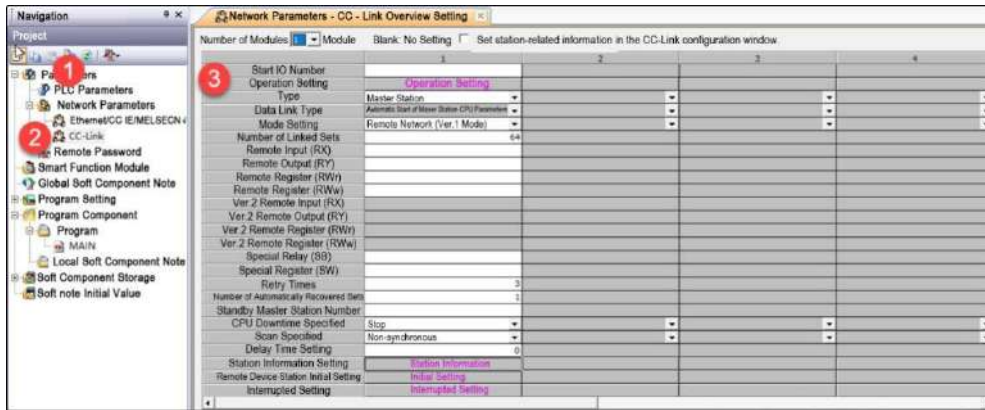

Figure 5-5-3 Opening the cc-link parameter setting window

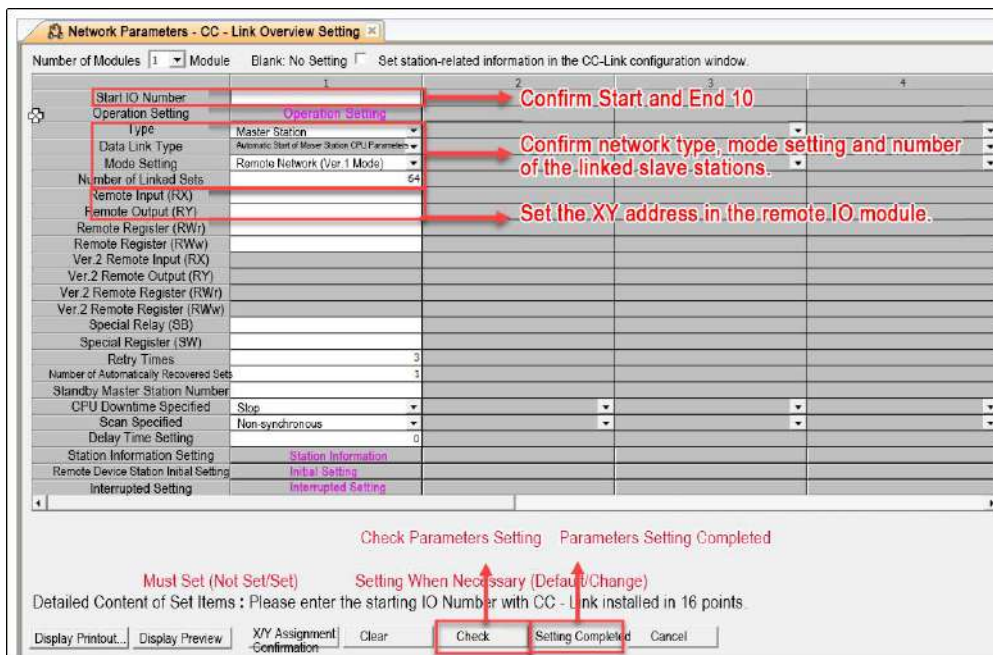

Figure 5-5-4 CC-link parameter Settings

Configure slave information. On the CC-link parameter setting screen, select Station Information to set parameters such as the station type, as shown in Figure 5-5-5.

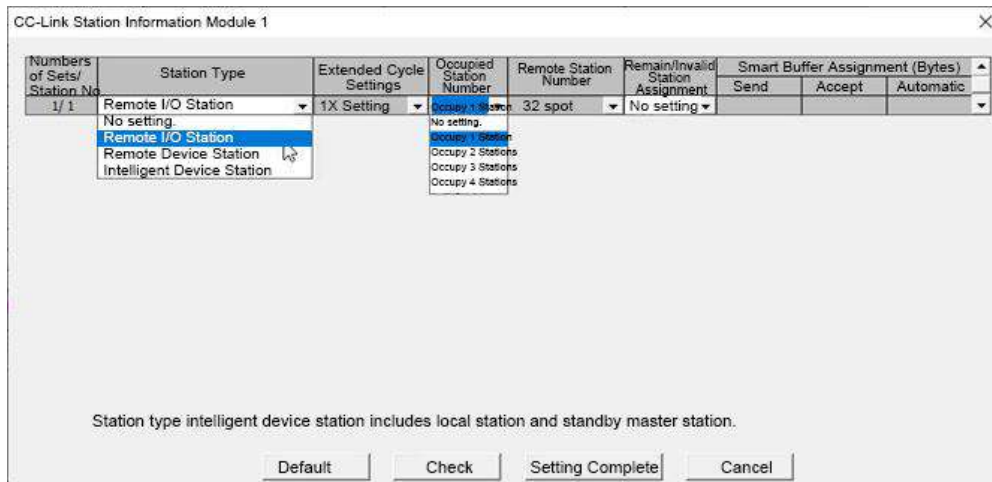

Figure 5-5-5 Configuring slave parameters

For details on the slave station parameters, see 2.1.6 CC-Link Adapter. The setting rules of ex-1040 as the remote device station are as follows:

The station information of THE CC-Link adapter EX-1040 in the Mitsubishi GX-Works software is the remote device station, one station is 32 points, which can be set according to the specific IO points connected by the user after the EX-1040. The maximum number of logical stations can be set, and a single logical station contains 32 points. A maximum of 4 x (32DI+32DO+4 ai +4 ao) can be connected.

The CC-Link remote IO adapter supports two logical station Settings, based on the first and last five bits of baud rate dip. The first five digits of the DIP switch correspond to the layer 5 communication rate, which is a fixed four logical stations. The number cannot be changed by default. When the dip switch is set to the last five digits, the number of logical stations can be changed as required. The communication rate of the first five digits remains the same. You can flexibly configure the logical stations as required. A set of 16-point digital inputs and outputs is a logical station, and a set of 4-channel analog inputs is a logical station.

For example, if the PLC is connected to five groups of EX-1040, and one group of EX-1040 is connected to the other two groups of EX-200H, EX300H, EX-4414, and EX-5414, the communication rate should be based on the master station. For details, see Table 5-5-6.

Table 5-5-6 communication parameter Settings

CC-link Dip switch corresponds to the station id						
Rate distance corresponding to dip station number	Fixed logic station	Dial the code: 0	Dial the code: 1	Dial the code: 2	Dial the code: 3	Dial the code: 4
	Variable logic station	Dial the code: 5	Dial the code: 6	Dial the code: 7	Dial the code: 8	Dial the code: 9
CC-link Communication rate and transmission distance		156kbps	625kbps	2.5 Mbps	5Mbps	10Mbps
		1200m	600m	200m	150m	100m

Based on ex-200H, EX300H, EX-4414, and EX-5414, the I/O module has a set of 32-point I/O inputs and outputs. One set of 4-channel analog inputs and the other set of 4-channel analog outputs. The maximum number of logical stations is 1 logical station. Specifically, the number of the first group is 1, the second group is 2, the third group is 3, and so on.

5.6 Connection between EX-1030 and PLC

Figure 5-6-1 shows the process for restoring the Modbus RTU module to factory Settings and setting parameters.

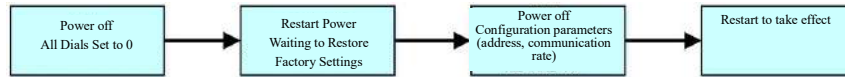

Figure 5-6-1 Process for restoring factory Settings

Note: the module is restored to factory Settings, only the parameters set by the user are cleared, such as watchdog activation, watchdog time, etc.

Module address The IP addresses of the input and output channels are related to the positions of modules. The Modbus RTU function codes used by modules remain unchanged. Figure 5-6-2 shows an example.

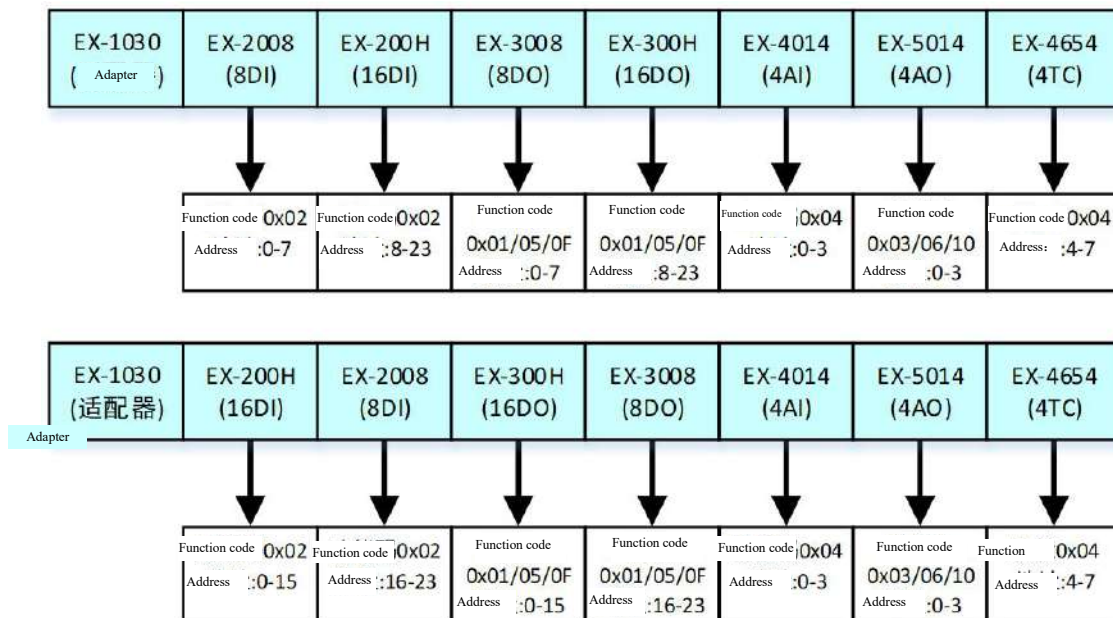

Figure 5-6-2 Module address allocation

5.6.1 Connection and Configuration between Modbus Poll software and EX-1030

1. Communication connection diagram, as shown in Figure 5-6-3.

Communication parameters in the case: baud rate 9600bps, data bit 8, stop bit 1, no check;The slave address is 1.

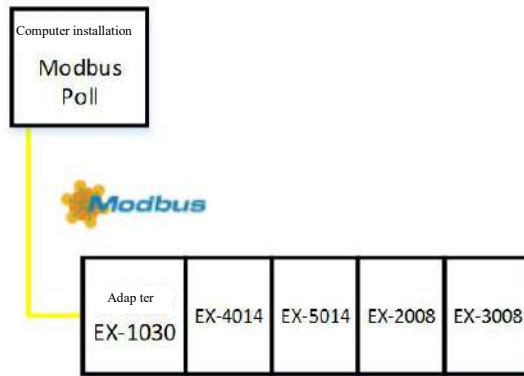

Figure 5-6-3 Communication connection diagram

2. Table 5-6-1 shows the hardware configuration

Table 5-6-1 Hardware configuration table

hardware	Quantity	note
Computer programming	1	Install the Modbus Poll
EX-1030	1	Modbus RTU adapter
EX-2008	1	Digital quantity input module
EX-3008	1	Digital output module
EX-4014	1	Analog input module
EX-5014	1	Analog output module
USB to 485 serial port	1	

3. Set the ex-1030 communication parameters as shown in Table 5-6-2

Table 5-6-2 Communications parameter Settings

The name of the	Set the value	note
Communication rate	9600bps	The communications rate dip switch is set to 5
Data bits	8	The default value
Parity bit	There is no	The default is
Stop bit	1	The default value
From the station address	1	Address DIP switch x 1 Set this parameter to 1 Address DIP switch x 10 is set to 0

4. Dip switch, as shown in Figure 5-6-4. Table 5-6-3 lists the dip switch parameters.

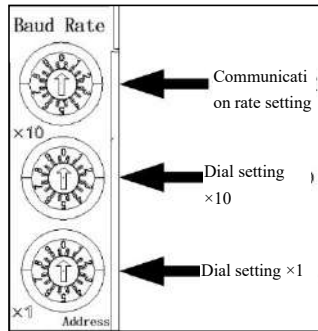

Figure 5-6-4 DIP switch

Table 5-6-3 Dip switch parameters

Communication rate Dip switch value	Baud rate value	note
0	-	
1	115200	
2	57600	
3	38400	
4	19200	
5	9600	
6	4800	
7	2400	
8	1200	
9	-	

For the Modbus RTU address, calculate the formula (N1 x 1 DIP switch, n2 x 10 DIP switch) :
 Address = N1 x 1 + N2 x 10.

5. Table 5-6-4 lists the Modbus RTU function codes supported by the EX-1030 adapter

Table 5-6-4 Modbus RTU function codes

Function code	function	Functional meaning	note
0x01	Read	Read digital output	For example, the EX-3XXX module
0x02	Read	Read digital quantity input	For example, the ex-2XXX module
0x03	Read	Read analog output	For example, the EX-5XXX module
0x04	Read	Read analog input	For example, the EX-4XXX module
0x05	Write	Write a single numeric	For example, the

		quantity	EX-3XXX module
0x06	Write	Write a single analog quantity	For example, the EX-5XXX module
0x0F	Write	Write multiple numeric quantities	For example, the EX-3XXX module
0x10	Write	Write multiple analog quantities	For example, the EX-5XXX module

Modbus Poll configuration and communication

Create a File Read ex-4014 module channel, select "New" from "File" in the menu bar, right click the blank channel, and choose "Read/ Write Definition", as shown in Figure 5-6-5.

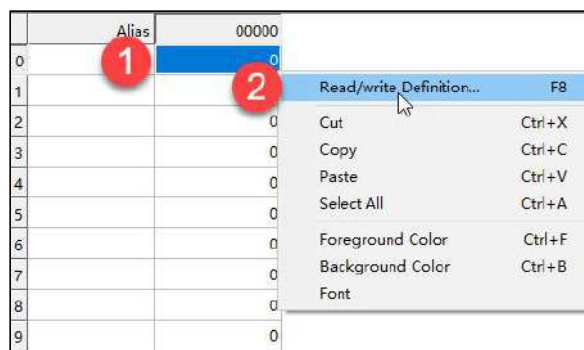

Figure 5-6-5 Channel configuration

The configuration parameters read the ex-4014 module data, including the slave address, function code, start address, and read address length (in the case of ex-1030, the address is set to 1), as shown in Figure 5-6-6.

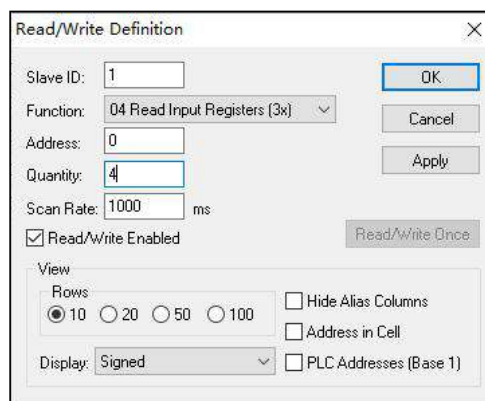

Figure 5-6-6 Configuration parameters

New file Configuration parameters Read the data of the EX-5014 module, including the slave address, function code, start address, and read address length (in the case of ex-1030, the address is set to 1), as shown in Figure 5-6-7.

Figure 5-6-7 Configuration parameters

New file Configuration parameters Read the data of ex-2008 module, including the slave address, function code, start address, and read address length (in the case of EX-1030, the address is set to 1), as shown in Figure 5-6-8.

Figure 5-6-8 Configuration parameters

New file Configuration parameters Read the data of the EX-3008 module, including the slave address, function code, start address, and read address length (in the case of ex-1030, the address is set to 1), as shown in Figure 5-6-9.

Figure 5-6-9 Configuration parameters

Create a file to write data to EX-5014. The parameters include the slave address, function code, start address, and read address length (in the case of EX-1030, the address is set to 1), as shown in Figure 5-6-10.

Read/Write Definition

Slave ID: 1

Function: 16 Write Multiple Registers

Address: 0

Quantity: 4

Scan Rate: 1000 ms

Read/Write Enabled

View

Rows: 10 20 50 100

Display: Signed

Hide Alias Columns

Address in Cell

PLC Addresses (Base 1)

Buttons: OK, Cancel, Apply, Read/Write Once

Figure 5-6-10 Configuration parameters

Create a file to write data to ex-2008. The parameters include the slave address, function code, start address, and read address length (in the case of EX-1030, the address is set to 1), as shown in Figure 5-6-11.

Read/Write Definition

Slave ID: 1

Function: 15 Write Multiple Coils

Address: 0

Quantity: 8

Scan Rate: 1000 ms

Read/Write Enabled

View

Rows: 10 20 50 100

Display: Signed

Hide Alias Columns

Address in Cell

PLC Addresses (Base 1)

Buttons: OK, Cancel, Apply, Read/Write Once

Figure 5-6-11 Setting parameters

Connect to ex-1030 through the USB-485 serial port module. Set parameters in the Modbus Poll software. Select Connect from the menu bar to set communication parameters, as shown in Figure 5-6-12.

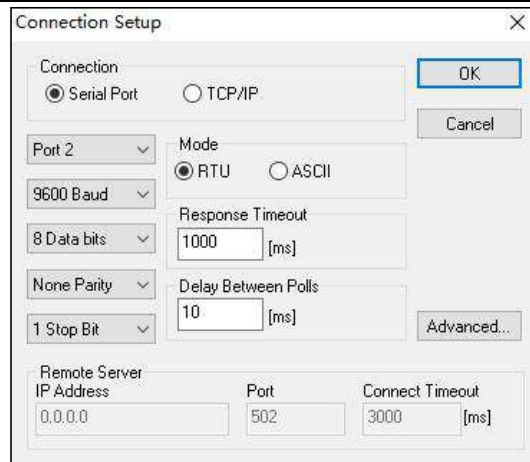

Figure 5-6-12 Communication parameter configuration

7. After the communication connection is completed, monitor the module status and write values to the DO/AO channel.

5.6.2 Connection and Configuration between Codesys and EX-1030

1. Communication connection diagram, as shown in Figure 5-6-15.

Communication parameters in the case: baud rate 115200bps, data bit 8, stop bit 1, no check;The slave address is 5.

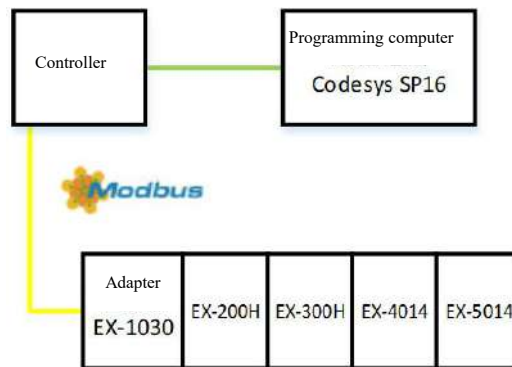

Figure 5-6-15 Communication connection diagram

2. Table 5-6-5 shows the hardware configuration

Table 5-6-5 Hardware configuration table

hardware	Quantity	note
Computer programming	1	Install the Codesys SP16
The controller	1	
EX-1030	1	Modbus RTU adapter
EX-2008	1	Digital quantity input module
EX-3008	1	Digital output module
EX-4014	1	Analog input module

EX-5014	1	Analog output module
---------	---	----------------------

3. New project and equipment configuration

Open Codesys programming software and configure communication, as shown in Figure 5-6-16. Double-click "Modbus_COM" to configure communication port and communication parameters, as shown in Figure 5-6-17. Configure the master station protocol and corresponding timeout parameters, as shown in Figure 5-6-18. The address corresponding to the slave channel is shown in Figure 5-6-21.

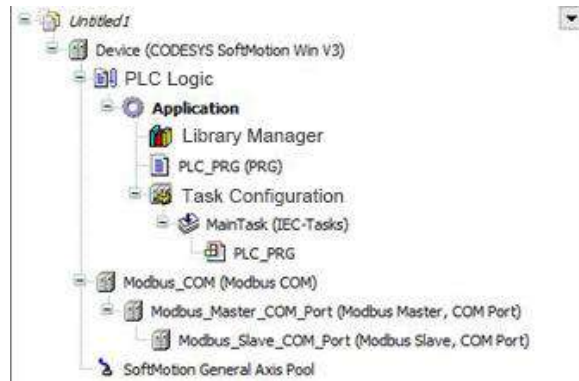

Figure 5-6-16 Configuration communication

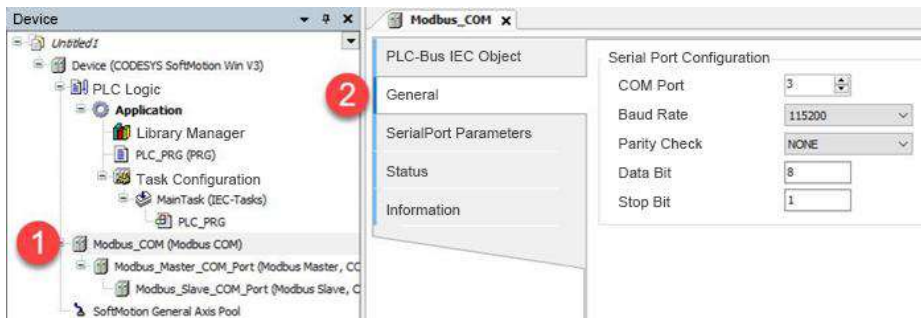

Figure 5-6-17 Configuring ports and communication parameters

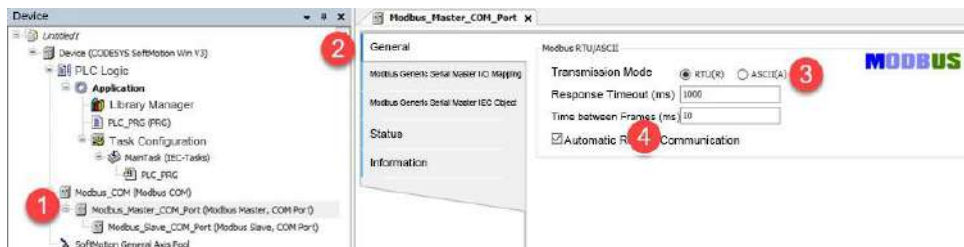

Figure 5-6-18 Configuring the master protocol and related timeout parameters

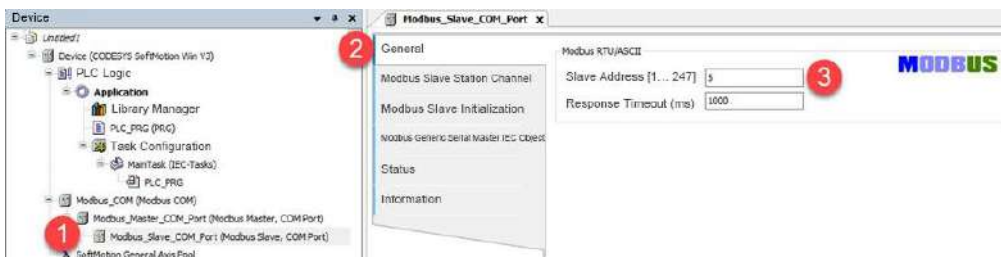

Figure 5-6-19 Setting the slave address

Name	Access Type	Intriguer	Read Offset	Length	Error Handling	Write Offset	Length	Note
0 EX-200H	Read Discrete Inputs (Function Code 02)	Cycle, t#100ms	16#0000	8	Keep last value			
1 EX-300H	Write Multiple Coils (Function Code 15)	Cycle, t#100ms				16#0000	8	
2 EX-4014	Read Input Registers (Function Code 04)	Cycle, t#100ms	16#0000	4	Keep last value			
3 EX-5014	Write Multiple Registers (Function Code 16)	Cycle, t#100ms				16#0000	4	

Figure 5-6-20 Adding a slave channel

Variable	Mapping	Channel	Address	Type	Unit	Description
		EX-200H	%IB0	ARRAY [0..0] OF BYTE		Read Discrete Inputs
		EX-200H[0]	%IB0	BYTE		Read Discrete Inputs
		EX-300H	%QB0	ARRAY [0..0] OF BYTE		Write Multiple Coils
		EX-300H[0]	%QB0	BYTE		Write Multiple Coils
		EX-4014	%IW1	ARRAY [0..3] OF WORD		Read Input Registers
		EX-4014[0]	%IW1	WORD		0x0000
		EX-4014[1]	%IW2	WORD		0x0001
		EX-4014[2]	%IW3	WORD		0x0002
		EX-4014[3]	%IW4	WORD		0x0003
		EX-5014	%QW1	ARRAY [0..3] OF WORD		Write Multiple Registers
		EX-5014[0]	%QW1	WORD		0x0000
		EX-5014[1]	%QW2	WORD		0x0001
		EX-5014[2]	%QW3	WORD		0x0002
		EX-5014[3]	%QW4	WORD		0x0003

Figure 5-6-21 Address corresponding to the slave channel

The program was programmed to define four variables and associate them with the actual physical address, as shown in Figure 5-6-22.

```

1  PROGRAM PLC_PRG
2  VAR
3      EX_200H:BYTE;
4      EX_300H:BYTE:=255;
5      EX_4014_1:WORD;
6      EX_5014_1:WORD:=2000;
7  END_VAR

1  EX_200H:=%IB0; //read the first 8 input channel values of ex-200h module
2  %QB0:=EX_300H; //write values to the first 8 output channels of ex-300h module
3  EX_4014_1:=%IW1; //read the value of the first input channel of ex-4014 module
4  %QW1:=EX_5014_1; //write value to the first output channel of ex-5014 module
    
```

Figure 5-6-22 Programming

5.6.3 Connection and Configuration between TIA Portal and EX-1030.

1. Communication connection diagram, as shown in Figure 5-6-23.

Communication parameters in the case: baud rate 115200bps, data bit 8, stop bit 1, no check;The slave address is 5.

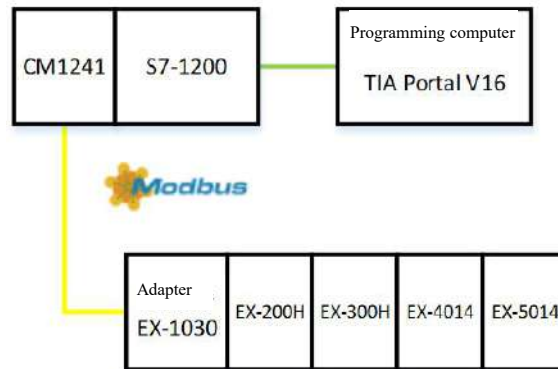

Figure 5-6-23 Communication connection diagram

2. Table 5-6-7 shows the hardware configuration

Table 5-6-7 Hardware configuration table

hardware	Quantity	note
Computer programming	1	Install the Codesys SP16
PLC	1	S7-1212C
Communication module	1	CM1241
EX-1030	1	Modbus RTU adapter
EX-2008	1	Digital quantity input module
EX-3008	1	Digital output module
EX-4014	1	Analog input module
EX-5014	1	Analog output module

3. New project and equipment configuration

Open the TIA Portal V16 programming software and configure the hardware, as shown in Figure 5-6-24. In the network view, double-click the CPU to enter the properties, select "System and Clock Memory", and select "Enable System Memory Bytes" and "Enable Clock Memory Bytes", as shown in Figure 5-6-25. Configure the CM1241 interface parameters. Double-click CM1241 to enter the properties and select "Port Configuration" to set communication parameters, as shown in Figure 5-6-26.

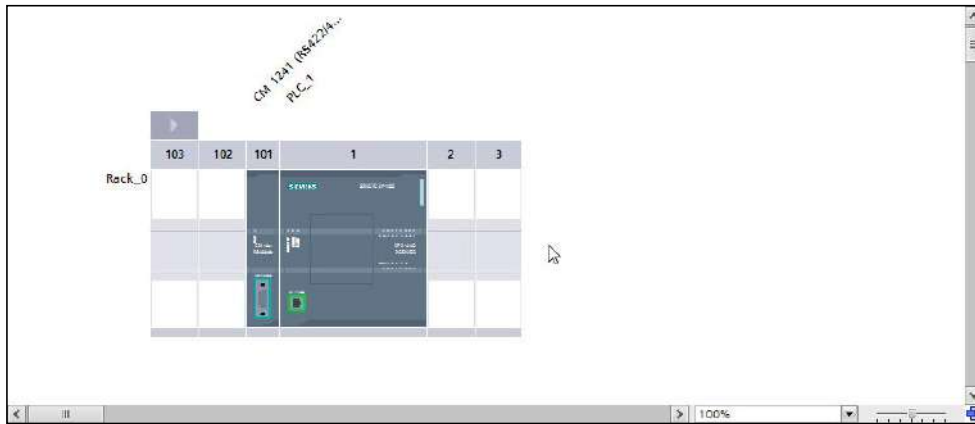

Figure 5-6-24 Configuration hardware

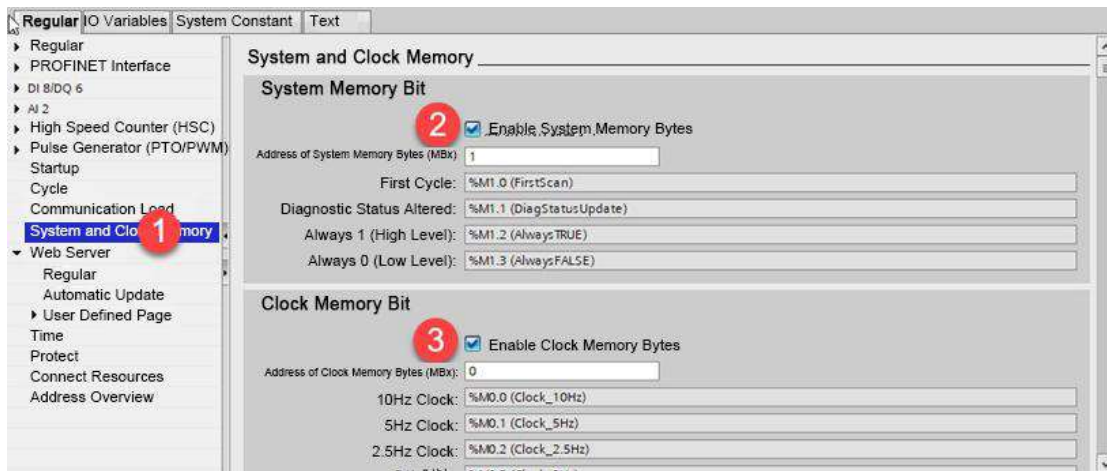

Figure 5-6-25 Enabling system storage and clock storage

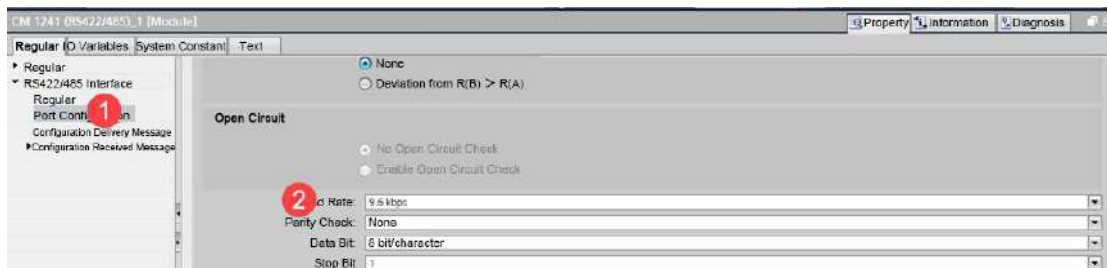

Figure 5-6-26 Setting communication parameters

Add the function block "MB_MASTER" of Modbus RTU master station to OB1, and write the polling program. The bit count value of program segment 1 is automatically increased by 1, and program segment 2 is the value of reading the 8 channels of EX-2008, as shown in Figure 5-6-27. Program section 3 is to write the values of the 8 channels of EX-3008, and program section 4 is to read the values of the first channel of EX-4014, as shown in Figure 5-6-28. The program section 5 is the value written to the first channel value of EX-5014, as shown in Figure 5-6-29.

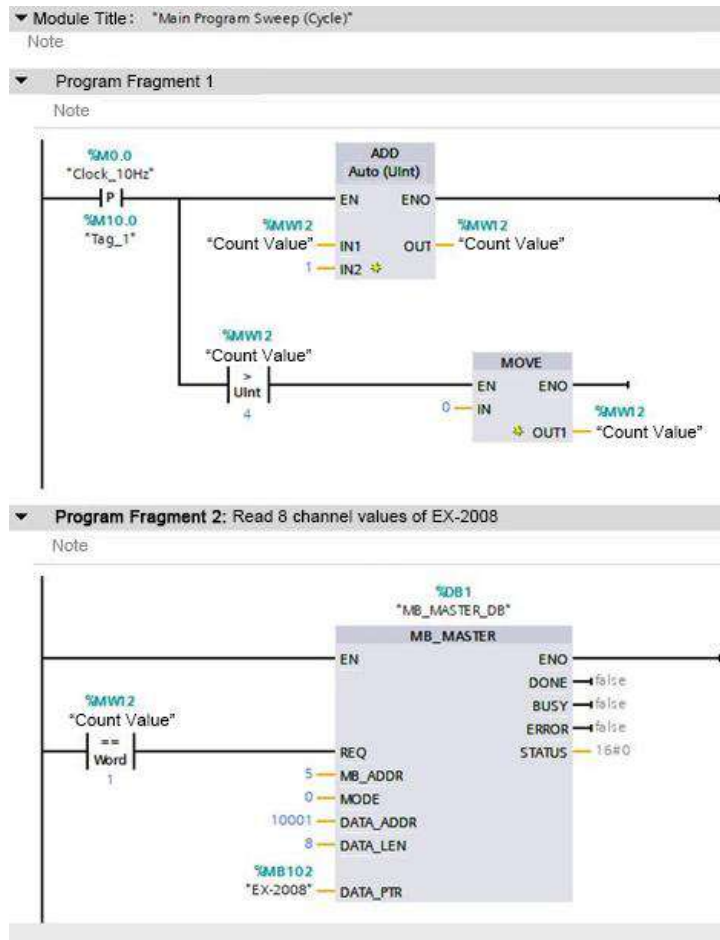
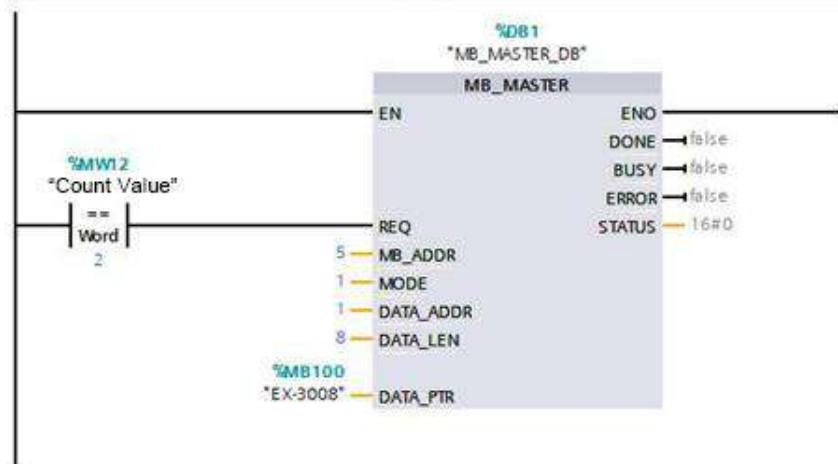

Figure 5-6-27 Program segment 1 and program segment 2

▼ Program Fragment 3: Read 8 channel values of EX-3008

Note



▼ Program Fragment 4: Read the first channel values of EX-4014

Note

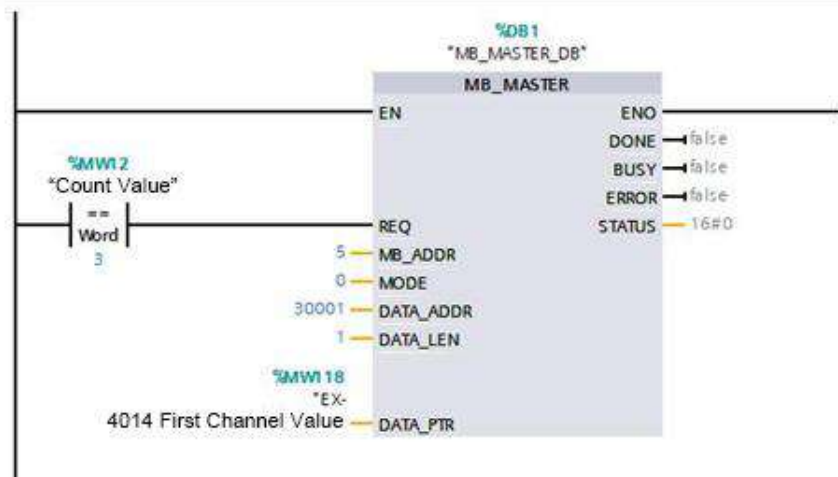

Figure 5-6-28 Program segment 3 and program segment 4

▼ Program Fragment 5: Read the first channel values of EX-5014

Note

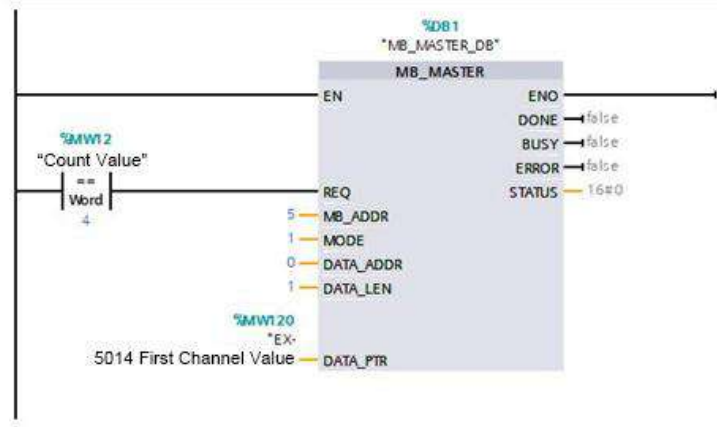

FIG. 5-6-29 Program section 5

Add an organization block OB100 to the program block, add a Modbus RTU configuration port function block to the program block, and configure the function block pins, as shown in Figure 5-6-30.

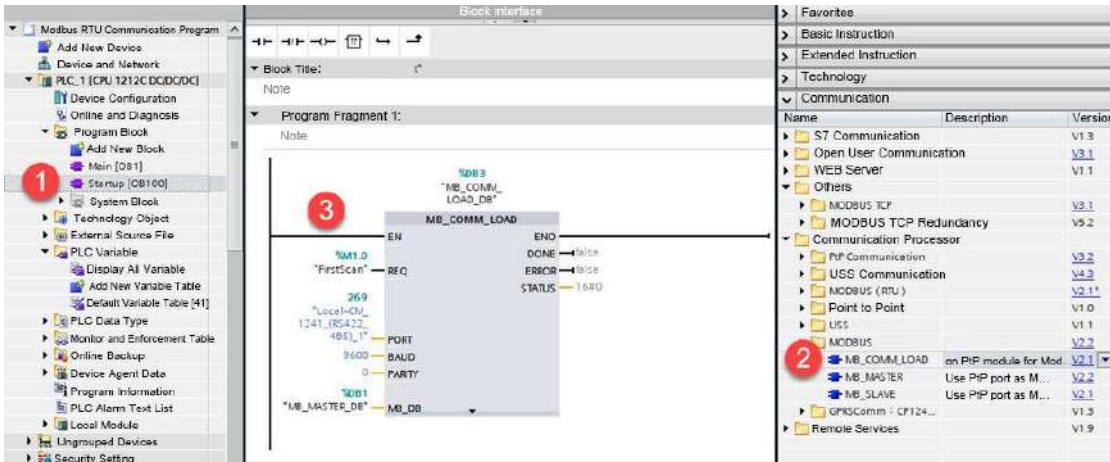

Figure 5-6-30 Adding OB100 tissue block

4. Program download and monitoring

Add a new monitoring list and add the variables that you want to monitor, as shown in Figure 5-6-31. Compile and download the program into PLC, and monitor the variables in the program, as shown in Figure 5-6-32.

	Name	Address	Display Format
1	"EX-2008"	%MB102	Unsigned Decimal
2	"EX-3008"	%MB100	Unsigned Decimal
3	"EX-4014 First Channel"	%MW118	Unsigned Decimal
4	"EX-5014 First Channel"	%MW120	Unsigned Decimal

Figure 5-6-31 Adding variables to be monitored

	Name	Address	Display Format	Monitor Value	Modify Value
1	"EX-2008"	%MB102	Unsigned Decimal	1	
2	"EX-3008"	%MB100	Unsigned Decimal	255	
3	"EX-4014 First Channel"	%MW118	Unsigned Decimal	1619	
4	"EX-5014 First Channel"	%MW120	Unsigned Decimal	1620	
5		<Newly Added>			

Figure 5-6-32 Monitoring variable values

5.7 Connection between EX-1120 and PLC

5.7.1 Connection and Configuration between Machine Expert and EX-1120

Note:

(1) The IP address segment is 192.168.0.X by default. You can use the IP Setting Tool to change the network segment and set the IP address of the adapter dip switch.

② On the right of ex-1120, input and output bytes for communication between IO module and EtherNet/IP are configured

If the ex-1120 has only input or output modules on the right, the output (O-->T) byte length is set to 1Byte or the input (T->O) byte length is set to 1Byte. If neither I/O module is available, the input (T->O) byte length and output (O->T) byte length are set to 1Byte.

③ Ex-1120 adapter includes two TYPES of PLC mode: normal PLC mode and special PLC mode. Special PLC refers to keens PLC, ordinary PLC refers to the other manufacturers except keens PLC, factory default PLC category mode for ordinary PLC.

The hardware configuration	Input (T->O) bytes	Output (O->T) bytes
EX-1120	1	1
EX-1120 EX-200H	2	1
EX-1120 EX-300H	1	2
EX-1120 EX-200H EX-300H	2	2

1. Communication connection diagram, as shown in Figure 5-7-1

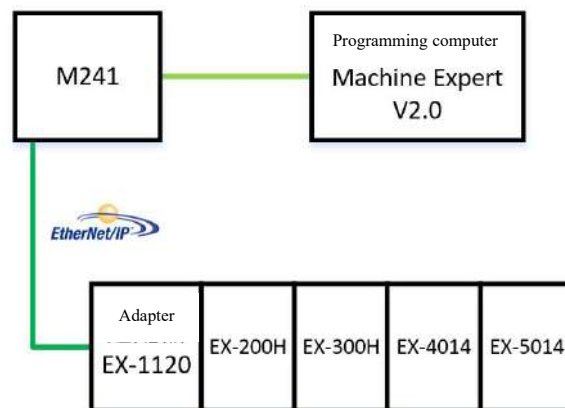

Figure 5-7-1 Communication connection diagram

2. Table 5-7-1 shows the hardware configuration

Table 5-7-1 Hardware configuration table

hardware	Quantity	note
Computer programming	1	Install Machine Expert V2.0
PLC	1	M241
EX-1120	1	EtherNet/IP adapter
EX-200H	1	Digital quantity input module
EX-300H	1	Digital output module
EX-4014	1	Analog input module
EX-5014	1	Analog output module

3. Set the IP address

In this example, the IP address of schneider M241 PLC is 192.168.1.39, and the default network segment of ex-1120 adapter is 192.168.0.x.

- ① Use software IP Setting Tool to modify the network segment to be consistent with PLC;
- ② Set the IP address to 192.168.1.33 through the DIP switch on the adapter.

4. Install the EDS file

On the menu bar, choose Tools > Device Repository. In the device repository window, choose Install, as shown in Figure 5-7-2. In the EDS folder, choose General Version > EX-1120_V1.1 and confirm the installation.

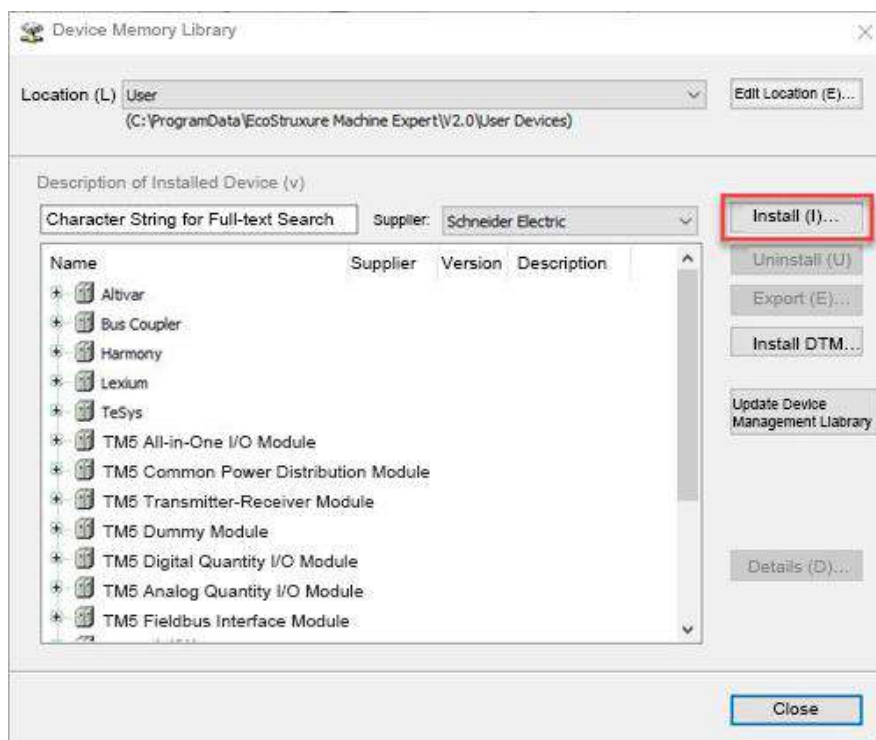

Figure 5-7-2 Installing the EDS file

5. New project and equipment configuration

Start Machine Expert V2.0, create a project, right-click "EtherNET_1" in the device tree, and choose "Add Device", as shown in Figure 5-7-3.

Choose Protocol Manager > Industrial Ethernet Manager in the Add Device window, as shown in Figure 5-7-4. Right-click "(Industrial Ethernet Manager)" > Add Device in the device window. Select DECOWELL AUTOMATION CO.,LTD for the supplier and ex-1120 in the equipment catalog, as shown in Figure 5-7-5.

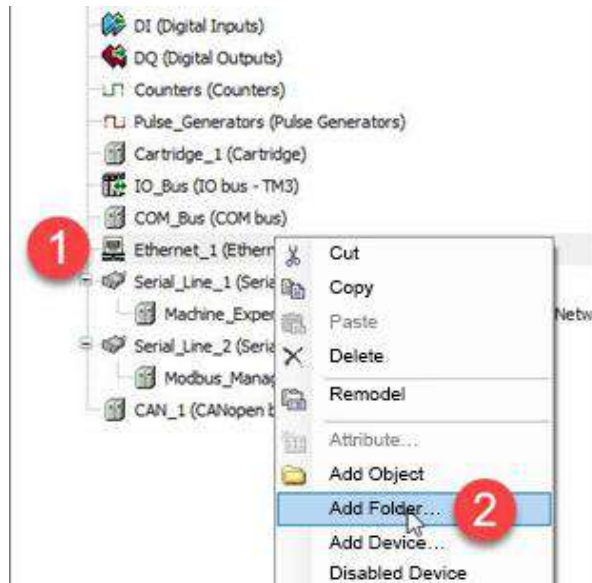

Figure 5-7-3 Adding devices

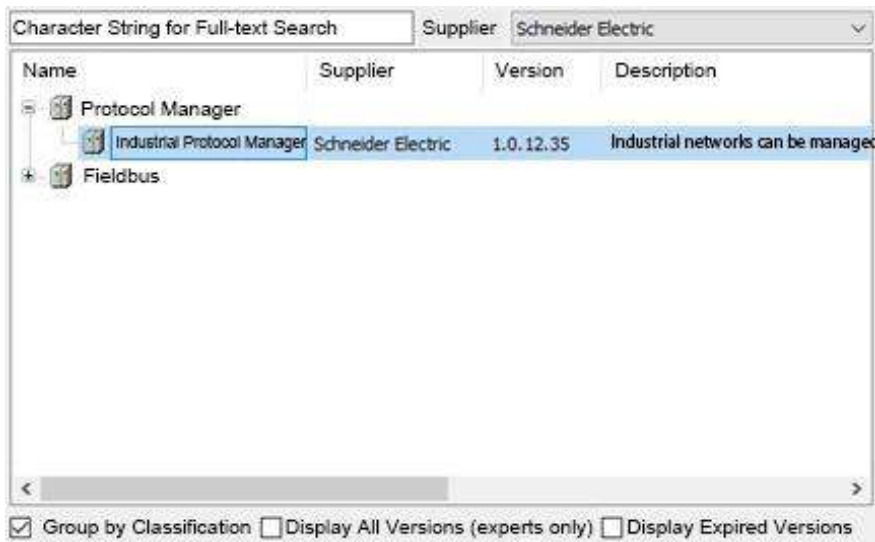

Figure 5-7-4 Adding an industrial Ethernet manager

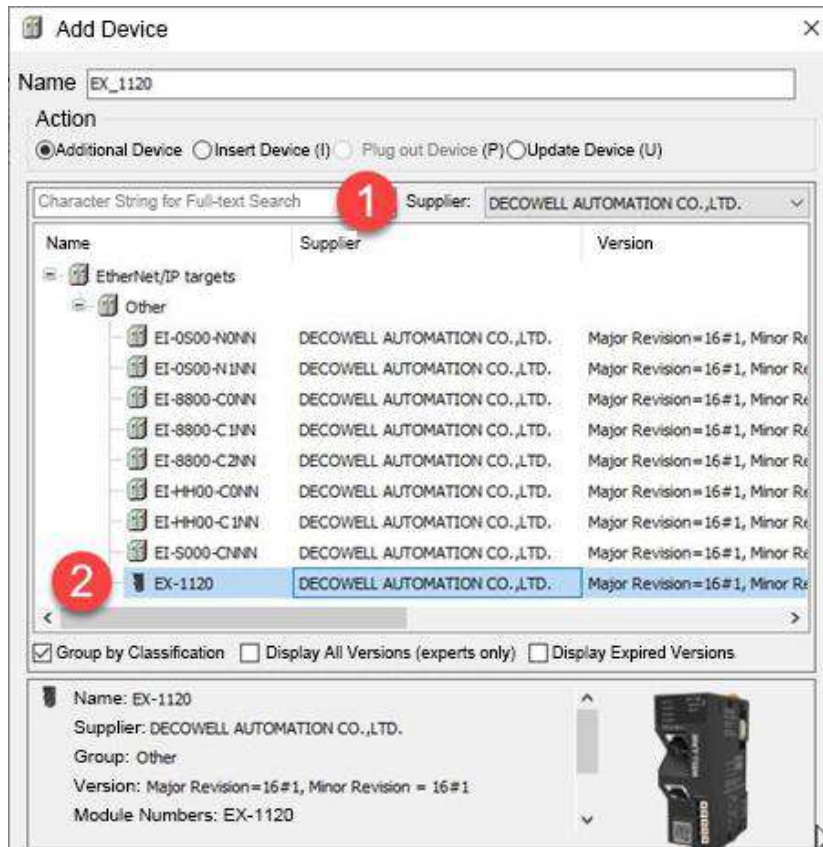

Figure 5-7-5 Adding ex-1120

To configure ex-1120 parameters, double-click EX-1120 in the device tree, and set the IP address to a fixed IP address, as shown in Figure 5-7-6.

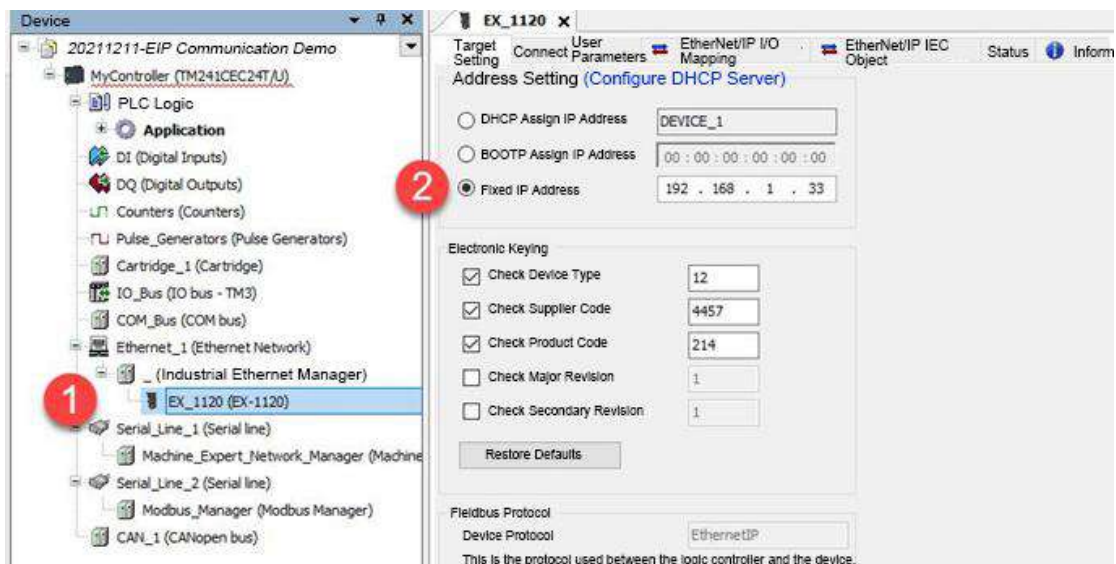

Figure 5-7-6 Configuring an IP address

Number of bytes occupied by computing modules:

Table 5-7-2 Number of bytes occupied by modules

The module type	Quantity	Input/output type	Occupied bytes
EX-2xx8	1	Input (T->O)	1
EX-2xxH	1	Input (T->O)	2
EX-2xxS	1	Input (T->O)	4
EX-3xx8	1	Output (O->T)	1
EX-3xxH	1	Output (O->T)	2
EX-3xxS	1	Output (O->T)	4
EX-4xx4	1	Input (T->O)	8
EX-4xx8	1	Input (T->O)	16
EX-5xx4	1	Output (O->T)	8
EX-5xx8	1	Output (O->T)	16

To configure connection parameters, double-click the default connection parameters, and set the output bytes (O->T) to 10 bytes and the input bytes (T->O) to 10 bytes in the edit connection window, as shown in Figure 5-7-7. View the IO address mapping, as shown in Figure 5-7-8.

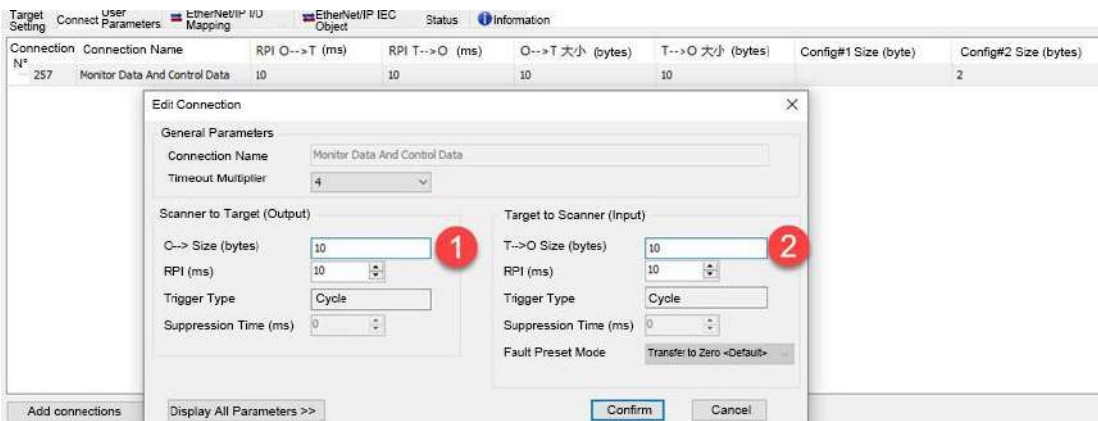

Figure 5-7-7 Configuring the input/output byte size

Variable	Mapping	Channel	Address	Type	Default Value	Unit	Description
		Input Monitor Data And Control Data	%IW7	ARRAY [0..4] OF WORD			
		Input Monitor Data And Control Data[0]	%IW7	WORD			
		Input Monitor Data And Control Data[1]	%IW8	WORD			
		Input Monitor Data And Control Data[2]	%IW9	WORD			
		Input Monitor Data And Control Data[3]	%IW10	WORD			
		Input Monitor Data And Control Data[4]	%IW11	WORD			
		Output Monitor Data And Control Data	%QW2	ARRAY [0..4] OF WORD			
		Output Monitor Data And Control Data[0]	%QW2	WORD			
		Output Monitor Data And Control Data[1]	%QW3	WORD			
		Output Monitor Data And Control Data[2]	%QW4	WORD			
		Output Monitor Data And Control Data[3]	%QW5	WORD			
		Output Monitor Data And Control Data[4]	%QW6	WORD			

Figure 5-7-8 IO address mapping

The physical address assignment corresponding to the actual module in the case:

Note: In actual hardware, the number of I/O modules configured for the EX-1120 adapter is the same as that of the model, but the sequence of the MODULES is different, and the physical address assignment for the modules is different, as shown in Figure 5-7-9 and 5-7-10.

Adapter	EX-200H	EX-300H	EX-4014	EX-5014
EX-1120				
	IW7	QW2	IW8	QW3
			IW9	QW4
			IW10	QW5
			IW11	QW6

Figure 5-7-9 I/O sorting and address assignment #1(application in case)

Adapter	EX-4014	EX-5014	EX-200H	EX-300H
EX-1120				
	IW7	QW2	IW11	QW3
	IW8	QW3		
	IW9	QW4		
	IW10	QW5		

Figure 5-7-10 I/O sorting and address assignment #2

In EtherNet/IP I/O mapping, always update variable is selected as "Enable 2 (always in bus cycle task)", and the program is downloaded into PLC, and the PLC running status and I/O mapping address are monitored, as shown in Figure 5-7-11.

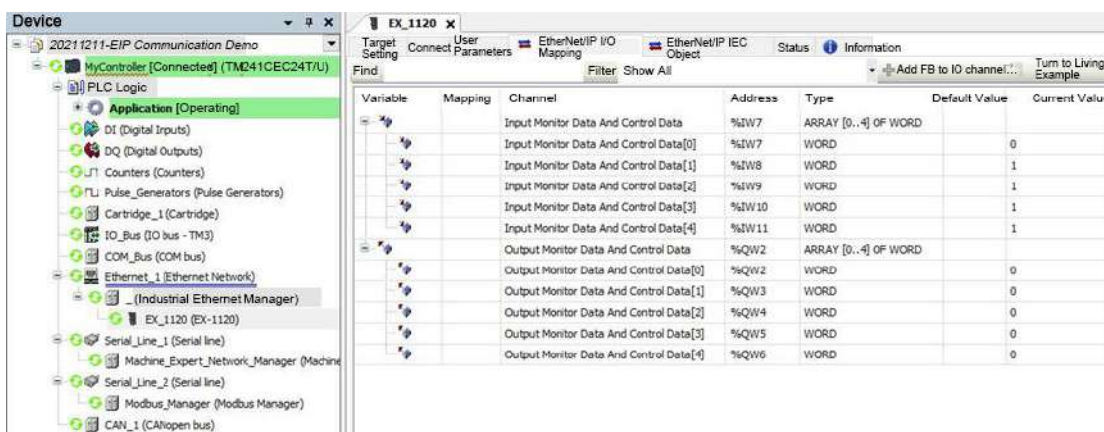

Figure 5-7-11 Program download and monitoring

5.7.2 Connection and Configuration between CODESYS and EX-1120

Note:

(1) The IP address segment is 192.168.0.X by default. You can use the IP Setting Tool to change the network segment and set the IP address of the adapter dip switch.

② On the right of ex-1120, input and output bytes for communication between IO module and EtherNet/IP are configured

If the ex-1120 has only input or output modules on the right, the output (O-->T) byte length is set to 1Byte or the input (T->O) byte length is set to 1Byte. If neither I/O module is available, the input (T->O) byte length and output (O->T) byte length are set to 1Byte.

③ Ex-1120 adapter includes two TYPES of PLC mode: normal PLC mode and special PLC mode. Special PLC refers to keens PLC, ordinary PLC refers to the other manufacturers except keens PLC, factory default PLC category mode for ordinary PLC.

The hardware configuration	Input (T->O) bytes	Output (O->T) bytes
EX-1120	1	1
EX-1120 EX-200H	2	1
EX-1120 EX-300H	1	2
EX-1120 EX-200H EX-300H	2	2

1. Communication connection diagram, as shown in Figure 5-7-12

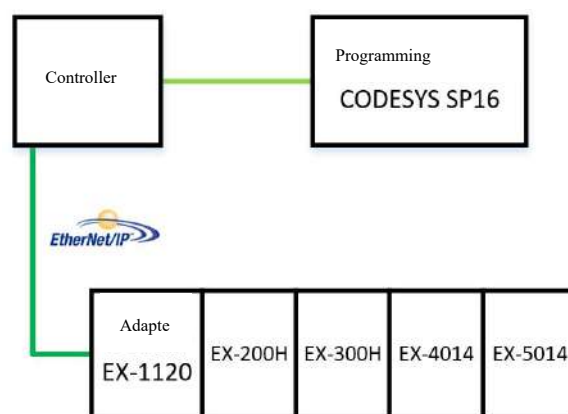

Figure 5-7-12 Communication connection diagram

2. Table 5-7-3 shows the hardware configuration

Table 5-7-3 Hardware configuration table

hardware	Quantity	note
Computer programming	1	Install the CODESYS SP16
The controller	1	
EX-1120	1	EtherNet/IP adapter
EX-200H	1	Digital quantity input module
EX-300H	1	Digital output module
EX-4014	1	Analog input module
EX-5014	1	Analog output module

3. Set the IP address

In this case, the IP address of the CODESYS controller is 192.168.1.198, and the default network segment of the ex-1120 adapter is 192.168.0.x.

- ① Use software IP Setting Tool to modify the network segment to be consistent with PLC;
- ② Set the IP address to 192.168.1.33 through the DIP switch on the adapter.

4. Install the EDS file

On the menu bar, choose Tools > Device Repository. In the device repository window, choose Install, as shown in Figure 5-7-13. In the EDS folder, choose General Version > EX-1120_V1.1 and confirm the installation.

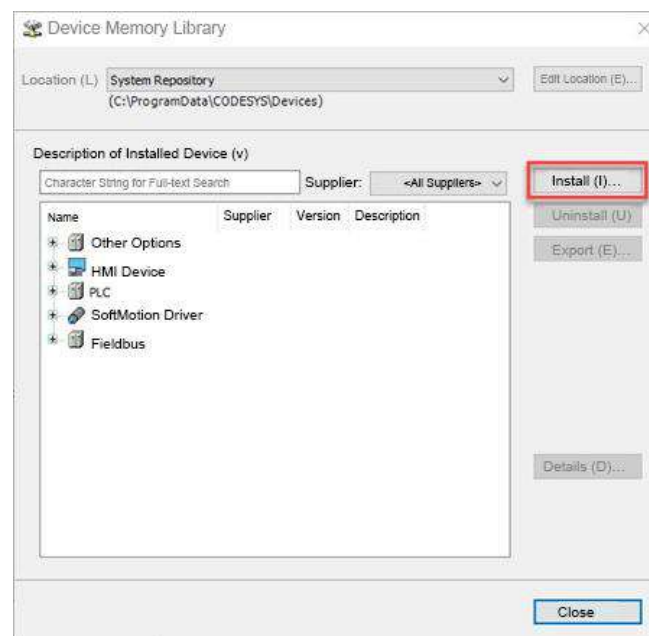

Figure 5-7-13 Installing the EDS file

5. New project and equipment configuration

Open CODESYS SP16, create a project, right-click Device in the Device tree, and choose Add Device. In the add Device window, choose Ethernet, as shown in Figure 5-7-14.

Right-click Ethernet in the device tree and choose Add Device. In the add Device window, choose Ethernet /IP Scanner, as shown in Figure 5-7-15.



Figure 5-7-14 Adding an Ethernet adapter

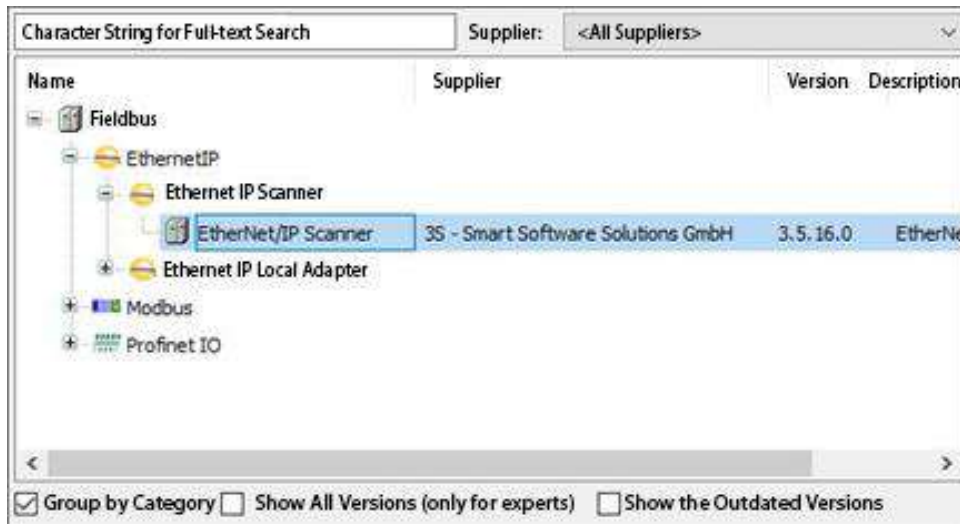

Figure 5-7-15 Adding the EthernetIP scanner

To configure the network adapter, double-click Ethernet in the device tree and select the network adapter to communicate with the Ethernet /IP slave, as shown in Figure 5-7-16.

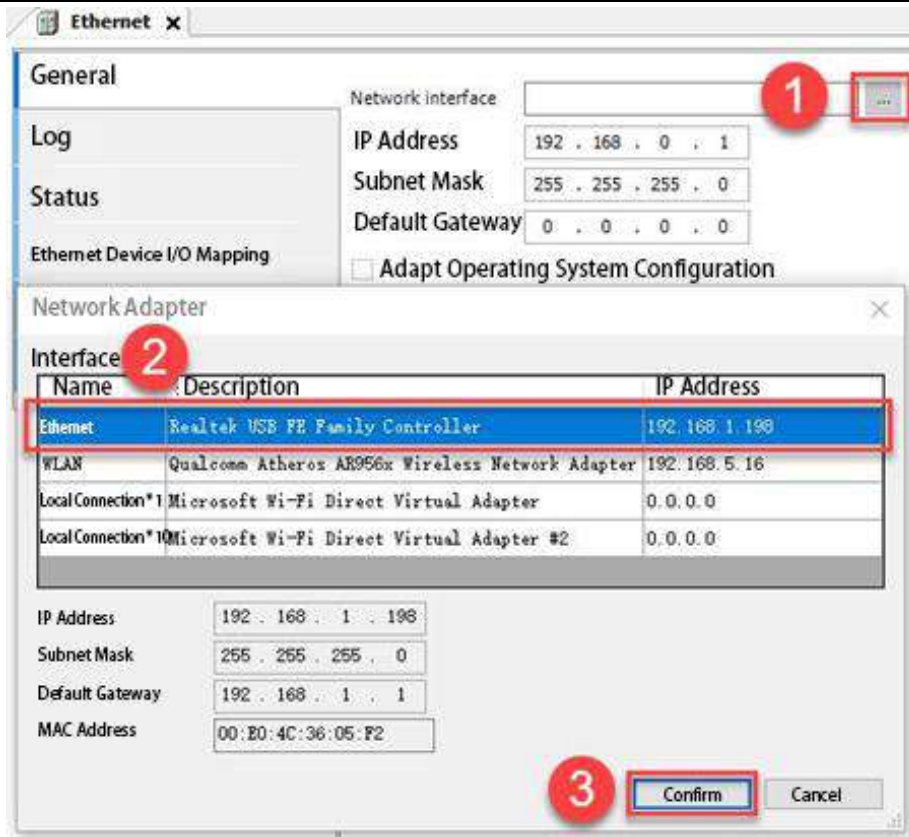

Figure 5-7-16 Configuring the network adapter for the Ethernet adapter

Right-click EtherNet_IP_Scanner in the device tree and choose Add Device. In the add device window, select EX-1120, as shown in Figure 5-7-17.



Figure 5-7-17 Adding the EX-1120 adapter

To configure the IP address of the EX-1120 adapter, double-click EX_1120 in the device tree, and enter the IP address (the IP address must be the same as that of the actual module), as shown in Figure 5-7-18.

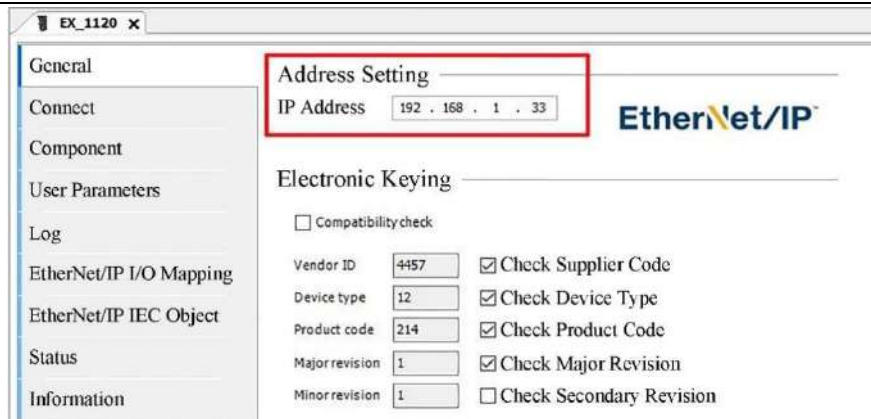

Figure 5-7-18 Configuring the IP address of the ex-1120 adapter

Number of bytes occupied by computing modules:

Table 5-7-4 Number of bytes occupied by modules

The module type	Quantity	Input/output type	Occupied bytes
EX-2xx8	1	Input (T- >O)	1
EX-2xxH	1	Input (T- >O)	2
EX-2xxS	1	Input (T- >O)	4
EX-3xx8	1	Output (O- >T)	1
EX-3xxH	1	Output (O- >T)	2
EX-3xxS	1	Output (O- >T)	4
EX-4xx4	1	Input (T- >O)	8
EX-4xx8	1	Input (T- >O)	16
EX-5xx4	1	Output (O- >T)	8
EX-5xx8	1	Output (O- >T)	16

Set the input and output bytes of the I/O module of the EX-1120 adapter (you need to set the input and output bytes based on the actual NUMBER of I/O modules to ensure normal communication), as shown in Figure 5-7-19. Then view the I/O mapping of EtherNet/IP communication, as shown in Figure 5-7-20.

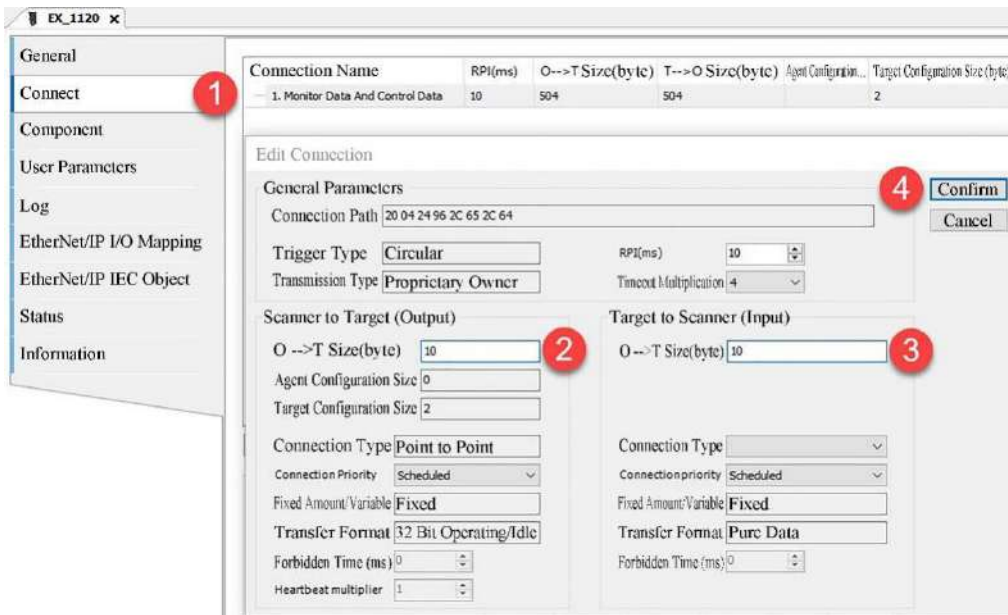

Figure 5-7-19 Configuring the size of input and output bytes

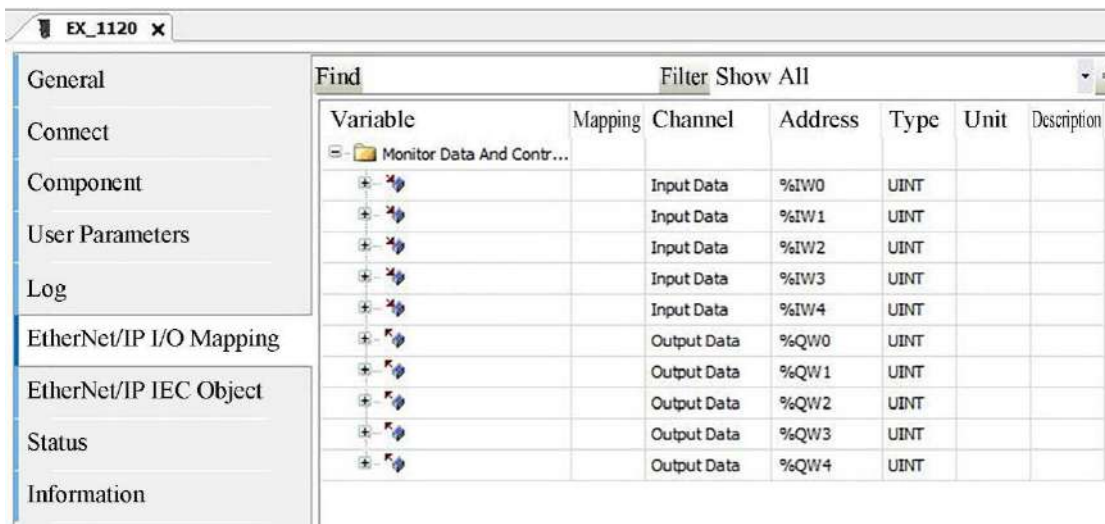

Figure 5-7-20 IO address mapping

The physical address assignment corresponding to the actual module in the case:

Note: In actual hardware, the number of I/O modules configured for the EX-1120 adapter is the same as that of the model, but the sequence of the MODULES is different, and the physical address assignment for the modules is different, as shown in Figure 5-7-21 and 5-7-22.

Adapter EX-1120	EX-200H	EX-300H	EX-4014	EX-5014
	IW0	QW0	IW1	QW1
			IW2	QW2
			IW3	QW3
			IW4	QW4

Figure 5-7-21 I/O sorting and address assignment #1(application in case)

Adapter EX-1120	EX-4014	EX-5014	EX-200H	EX-300H
	IW0	QW0	IW4	QW4
	IW1	QW1		
	IW2	QW2		
	IW3	QW3		

Figure 5-7-22 I/O sorting and address assignment #2

In EtherNet/IP I/O mapping, always update variable is selected as "Enable 2 (always in bus cycle task)", and the program is downloaded into PLC, and the PLC running status and I/O mapping address are monitored, as shown in Figure 5-7-23.

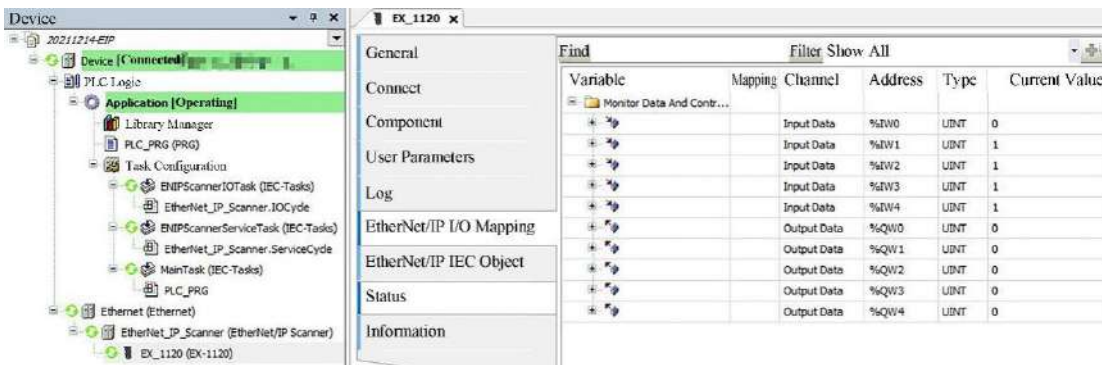

Figure 5-7-23 Program download and monitoring

5.7.3 Connection and Configuration between Sysmac Studio and EX-1120

Note:

(1) The IP address segment is 192.168.0.X by default. You can use the IP Setting Tool to change the network segment and set the IP address of the adapter dip switch.

② On the right of ex-1120, input and output bytes for communication between IO module and EtherNet/IP are configured

If the ex-1120 has only input or output modules on the right, the output (O-->T) byte length is set to 1Byte or the input (T->O) byte length is set to 1Byte. If neither I/O module is available, the input (T->O) byte length and output (O->T) byte length are set to 1Byte.

③ Ex-1120 adapter includes two TYPES of PLC mode: normal PLC mode and special PLC mode. Special PLC refers to keens PLC, ordinary PLC refers to the other manufacturers except keens PLC, factory default PLC category mode for ordinary PLC.

The hardware configuration	Input (T->O)	Output (O->T)
----------------------------	--------------	---------------

	bytes	bytes
EX-1121	1	1
EX-1121 EX-200H	2	1
EX-1121 EX-300H	1	2
EX-1121 EX-200H EX-300H	2	2

1. Communication connection diagram, as shown in Figure 5-7-24

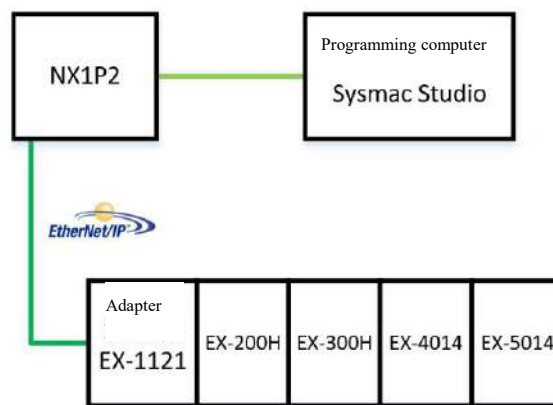

Figure 5-7-24 Communication connection diagram

2. Table 5-7-5 shows the hardware configuration

Table 5-7-5 Hardware configuration table

hardware	Quantity	note
Computer programming	1	Install the Sysmac Studio
NX1P2	1	
EX-1120	1	EtherNet/IP adapter
EX-200H	1	Digital quantity input module
EX-300H	1	Digital output module
EX-4014	1	Analog input module
EX-5014	1	Analog output module

3. Set the IP address

In this case, the IP address of omron NX1P2 PLC is 192.168.1.39, and the default network segment of ex-1120 adapter is 192.168.0.x.

- ① Use software IP Setting Tool to modify the network segment to be consistent with PLC;
- ② Set the IP address to 192.168.1.33 through the DIP switch on the adapter.

4. New project and equipment configuration

Open the Sysmac Studio programming software creation project and configure the EtherNet/IP port as a fixed IP address (the same as the ACTUAL PLC port IP address), as shown in Figure 5-7-25.



Figure 5-7-25 EtherNet/IP port Settings

Create all variables, and create input and output variables in global variables. The length of the variables must be the same as the length of input and output bytes in the actual module, as shown in Figure 5-7-26.

Number of bytes occupied by computing modules:

Table 5-7-6 Number of bytes occupied by modules

The module type	Quantity	Input/output type	Occupied bytes
EX-2xx8	1	Input (T->O)	1
EX-2xxH	1	Input (T->O)	2
EX-2xxS	1	Input (T->O)	4
EX-3xx8	1	Output (O->T)	1
EX-3xxH	1	Output (O->T)	2
EX-3xxS	1	Output (O->T)	4
EX-4xx4	1	Input (T->O)	8
EX-4xx8	1	Input (T->O)	16
EX-5xx4	1	Output (O->T)	8
EX-5xx8	1	Output (O->T)	16

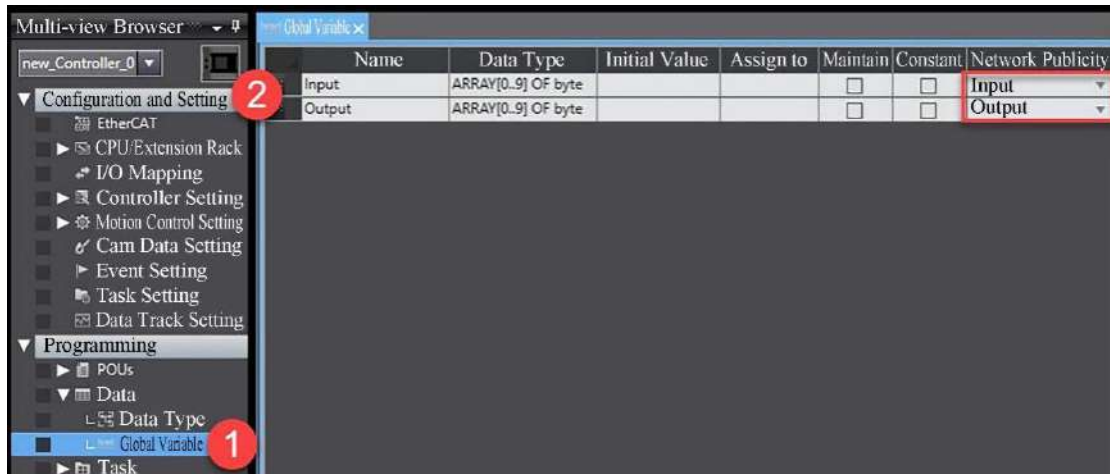

Figure 5-7-26 Creating global variables

On the menu bar, choose Tools > EtherNet/IP Connection Settings. In the EtherNet/IP list window, double-click the node address to open the EtherNet/IP port connection Settings window, as shown in Figure 5-7-27.

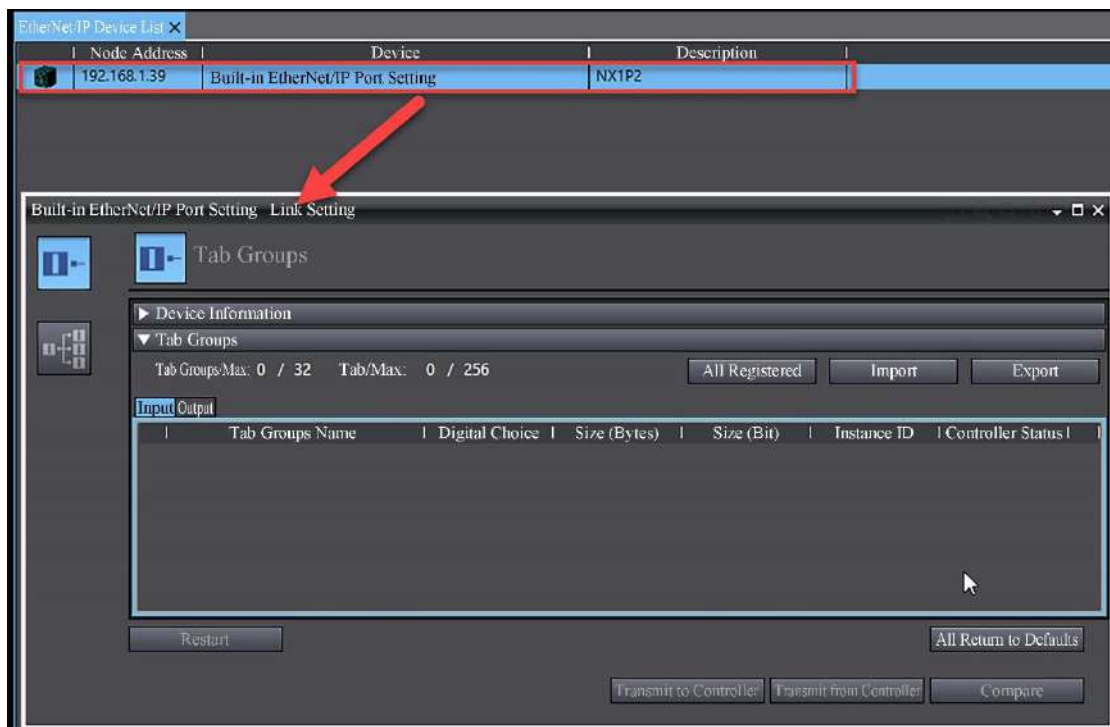

Figure 5-7-27 Opening the built-in EtherNet/IP port Settings connection Settings window

Register variables. In the built-in EtherNet/IP port Settings connection Settings window, select "Label Groups" window and click "Register All" to register the newly created global variables, as shown in Figure 5-7-28.

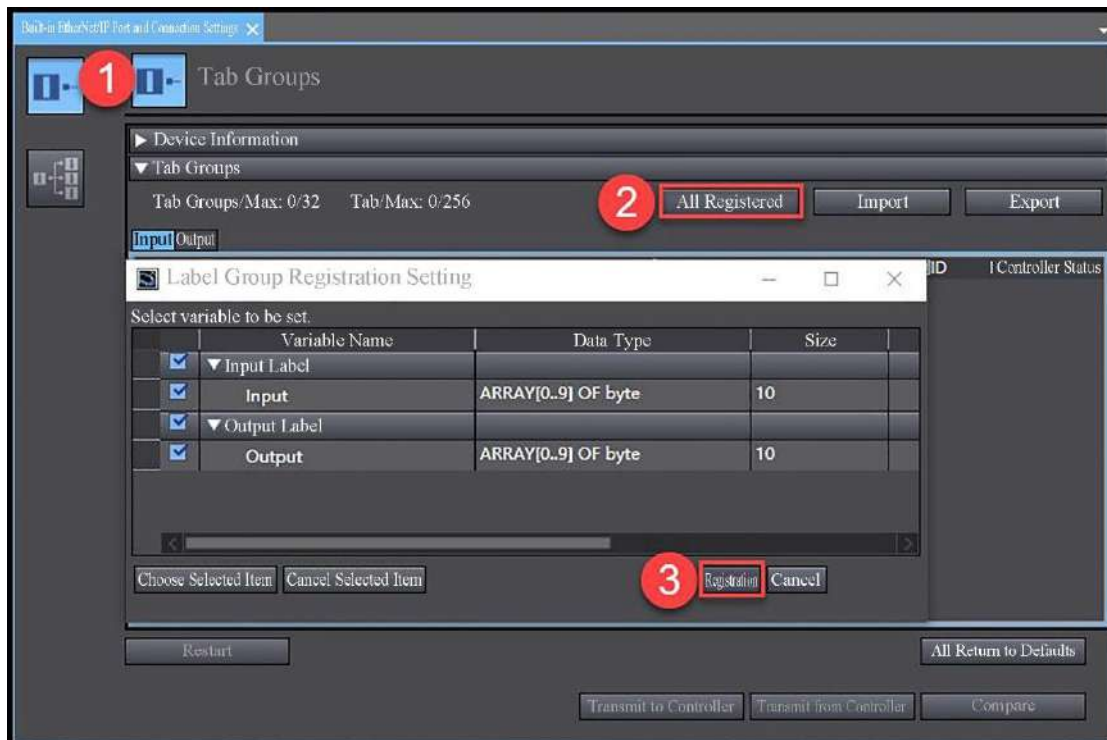

Figure 5-7-28 Registered variables

Install the EDS file, right-click in the blank area of the toolbox on the right of the connection setting window, and choose Show EDS Library, as shown in Figure 5-7-29. In the EDS library window, click Install to open the EDS file to be installed, as shown in Figure 5-7-30.

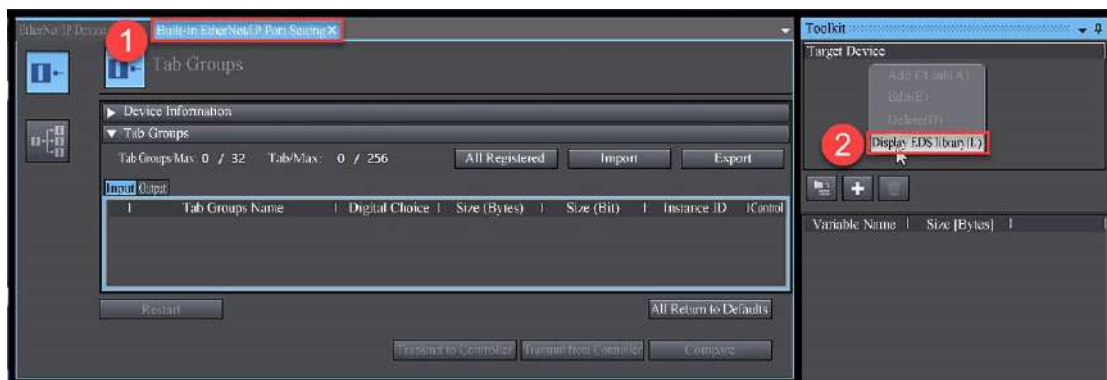

Figure 5-7-29 shows the EDS library



Figure 5-7-30 Installing the EDS file

To add devices to communicate with and set parameters, select "Add Target Device" in the toolbox, as shown in Figure 5-7-31. Enter the EtherNet/IP slave IP address, slave model, and revised version, and click "Add" in the lower left corner of the motor.

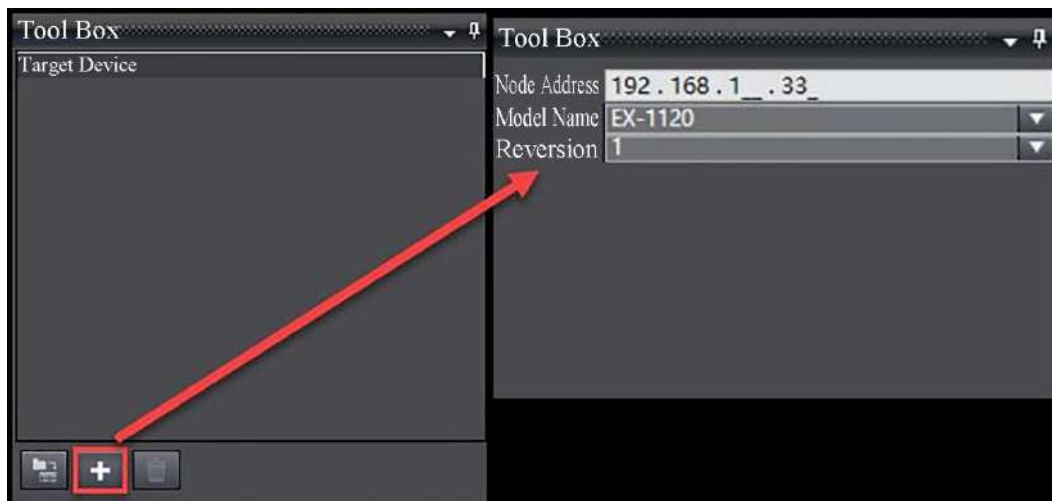

Figure 5-7-31 Adding a target device

Drag the target device 192.168.1.33 EX-1120 version 1 from the toolbox to the connection, as shown in Figure 5-7-32.

Set the target device parameters. The input target variable of ex-1120 is 100, the output target variable is 101, the input and output bytes are 10, and the start variable is the global variable registered, as shown in Figure 5-7-33.

Switch PLC to online, and switch PLC to programming mode, and then select "Send to Controller", as shown in Figure 5-7-34;

Transfer PLC online, and then download the program into PLC. IO module sequencing corresponds to the actual address, as shown in Figure 5-8-35 and 5-8-36.

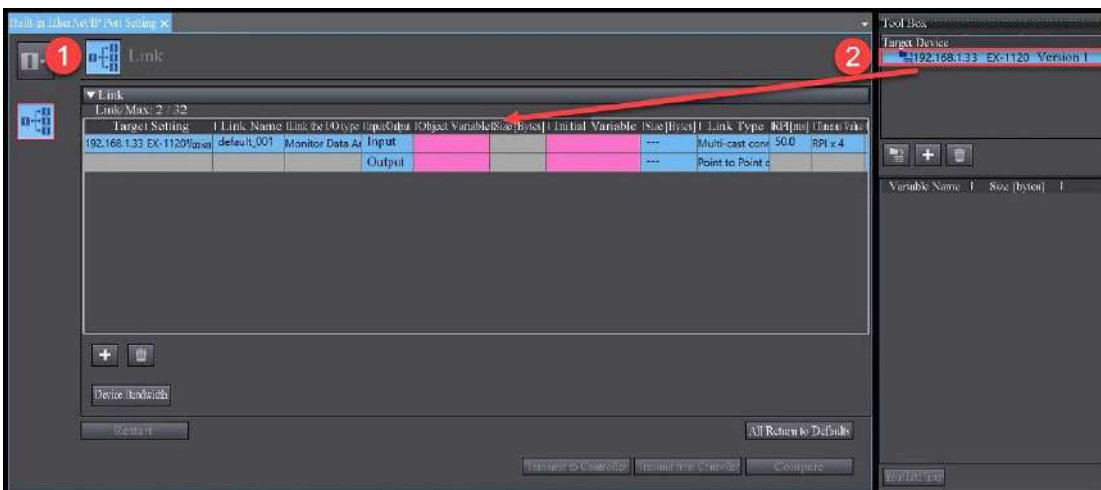

Figure 5-7-32 Adding a connected device

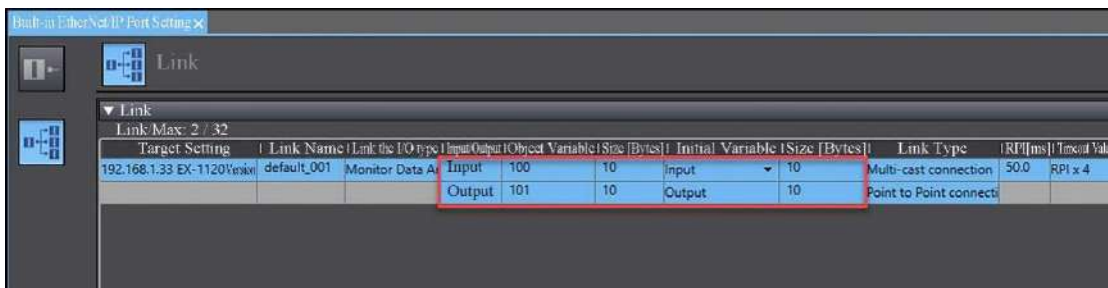

Figure 5-7-33 Configuring target device parameters

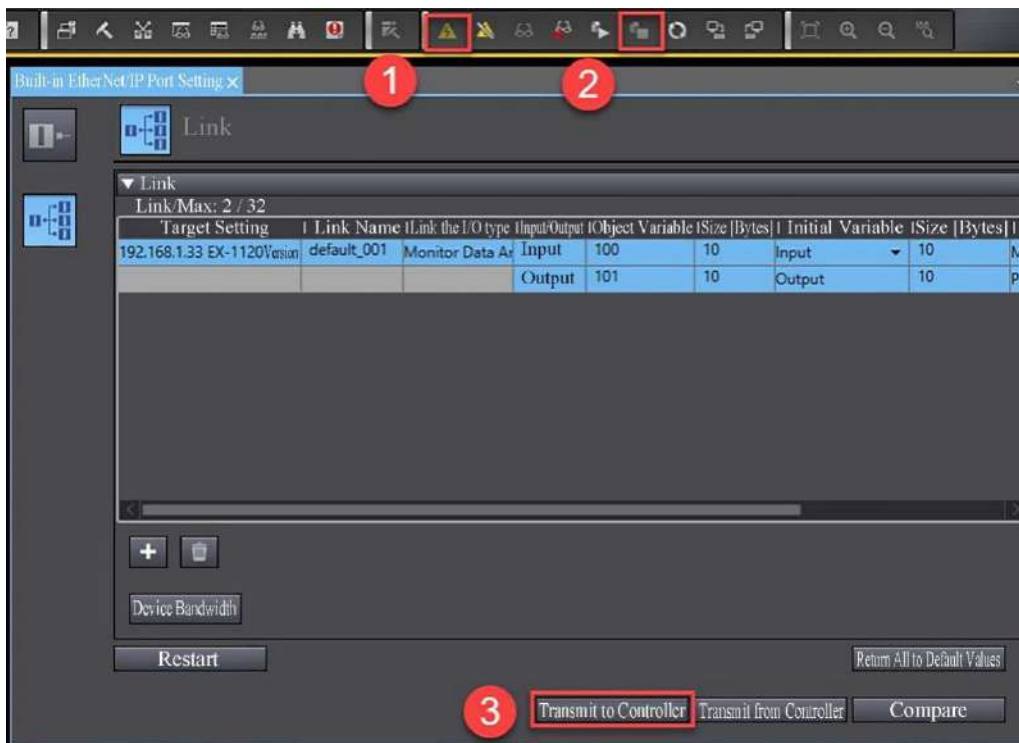

Figure 5-7-34 Transferring the EtherNet/IP configuration to the controller

Channel/module	EX-1120	EX-200H	EX-300H	EX-4014	EX-5014
Channel 0	-	Input[0][1]	Output[0][1]	Input[2] [3]	Output[2][3]
Channel 1	-	-	-	Input[4] [5]	Output[4][5]
Channel 2	-	-	-	Input[6][7]	Output[6] [7]
Channel 3	-	-	-	Input[8][9]	Output[8][9]

Figure 5-7-35 Mapping between IO module sequencing and actual address (application in case)

Channel/module	EX-1120	EX-4014	EX-5014	EX-200H	EX-300H
Channel 0	-	Input[0][1]	Output[0][1]	Input[8] [9]	Output[8][9]
Channel 1	-	Input[2] [3]	Output[4][5]	-	-
Channel 2	-	Input[4] [5]	Output[6] [7]	-	-
Channel 3	-	Input[6][7]	Output[8][9]	-	-

Figure 5-7-36 Mapping between I/O module sequencing and actual addresses

5.7.4 Connection and configuration between KV STUDIO and EX-1120

Note: The default IP address segment is 192.168.0.X. You can use the IP Setting Tool to modify the IP address segment and set the IP address with the DIP switch of the adapter.

The EX-1120 adapter includes two TYPES of PLC modes: normal PLC and special PLC mode. Special PLC refers to keens PLC, ordinary PLC refers to the other manufacturers except keens PLC, factory default PLC category mode for ordinary PLC.

1. Communication connection diagram, as shown in Figure 5-7-37

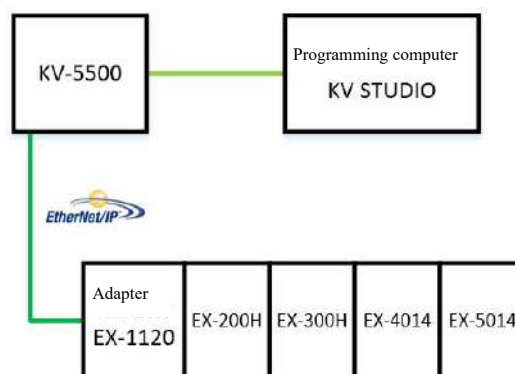

Figure 5-7-37 Communication connection diagram

2. Table 5-7-7 shows the hardware configuration

Table 5-7-7 Hardware configuration table

hardware	Quantity	note
----------	----------	------

Computer programming	1	Install the KV STUDIO
PLC	1	KV-5500
EX-1120	1	EtherNet/IP adapter
EX-200H	1	Digital quantity input module
EX-300H	1	Analog output module
EX-4014	1	Analog input module
EX-5014	1	Analog output module

3. Set the IP address

In this case, the IP address of KV-5500 PLC is 192.168.1.31, and the default network segment of ex-1120 adapter is 192.168.0.x.

- ① Use software IP Setting Tool to modify the network segment to be consistent with PLC;
- ② Set the IP address to 192.168.1.33 through the DIP switch on the adapter.

4. Copy XML files

Copy all files in the "Keens Version" folder to the KV STUDIO software folder:

"C:\ProgramData\KEYENCE\KVS11G_Trial\KVS\EIP_Eds"

5. New project and equipment configuration

Open KV STUDIO software, create a new project, and double-click "EtherNet/IP" in the project device tree to open the EtehrNET/IP Settings window, as shown in Figure 5-7-38.



Figure 5-7-38 Opening the EtherNet/IP Settings window

Install the EDS file. On the menu bar of the EtherNet/IP configuration window, choose EDS File > Login. In the EDS folder, choose Common Version > EX-1120, as shown in Figure 5-7-39.

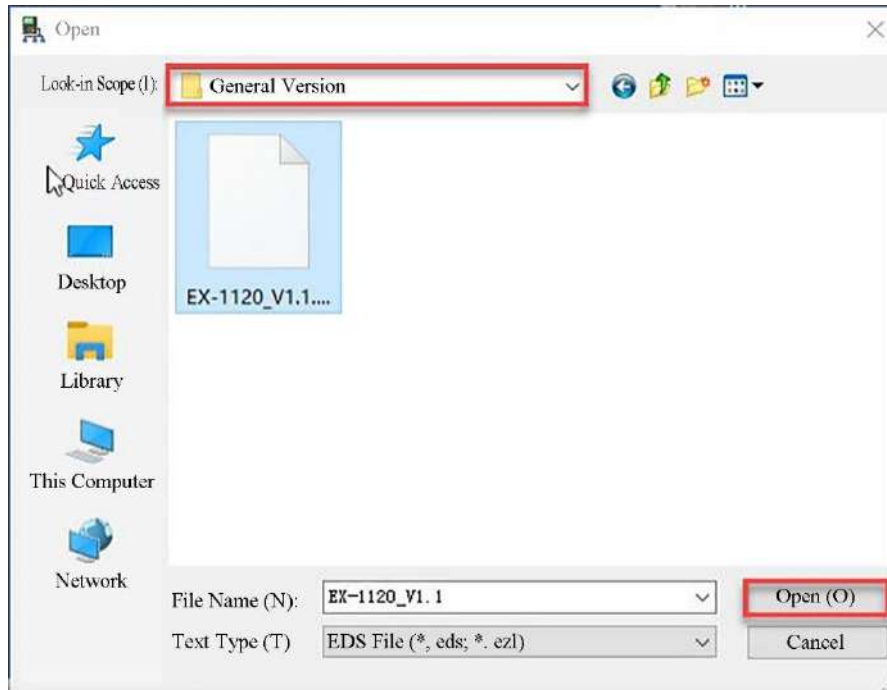

Figure 5-7-39 Installing the EDS file

Set the ex-1120 adapter mode to special PLC mode (the factory default is common mode). Right-click the blank area in the device Search option on the right and choose Device Search, as shown in Figure 5-7-40.

Add the scanned devices to the scan list. Right-click the devices to be added and choose Add to scan List, as shown in Figure 5-7-41.

For transmission adapter Settings, right-click "EX-1120" in the device list and choose "Transmission Adapter Settings", as shown in Figure 5-7-42.

In the transfer adapter setting window, change the adapter No.100 setting value to "1: Special PLC" and write the adapter, as shown in Figure 5-7-43. After the writing is complete, the EX-1120 must be powered off and restarted.

In the EtherNet/IP Settings window, select KV-5500 and right click "Auto Configuration" to re-read the EX-1120, as shown in Figure 5-7-44.

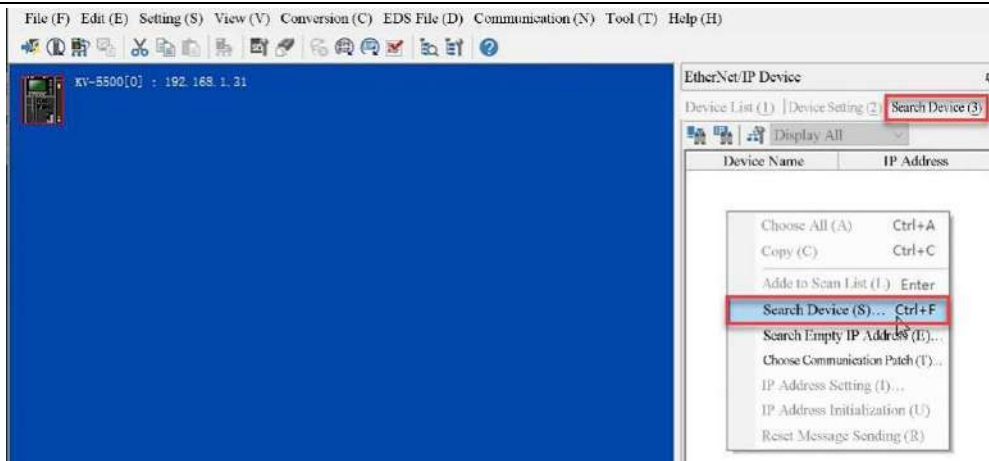

Figure 5-7-40 Device search

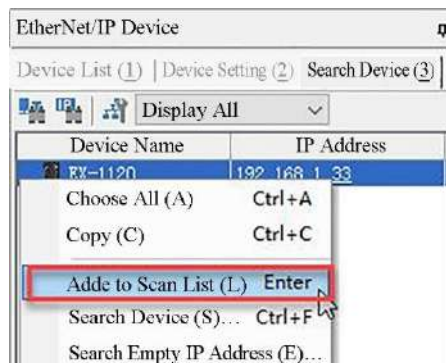

Figure 5-7-41 Adding devices to the scan list



Figure 5-7-42 Adapter transfer Settings

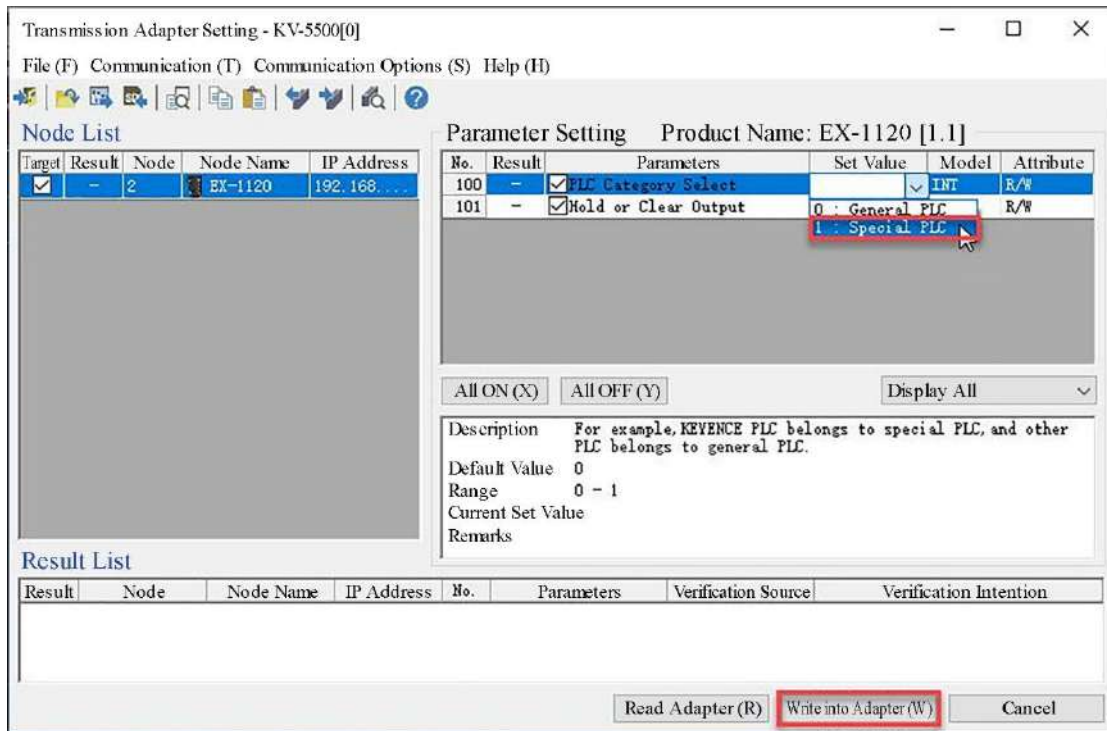

Figure 5-7-43 Write adapter

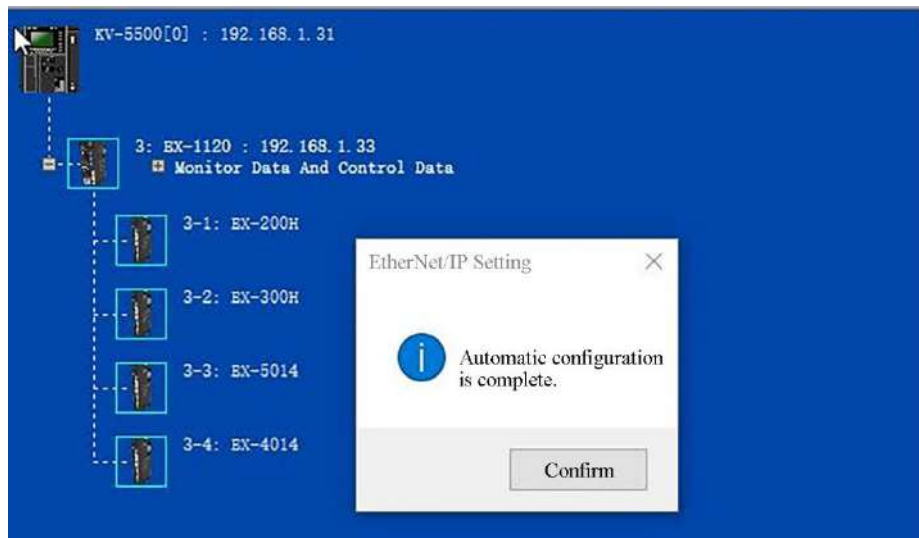

Figure 5-7-44 Re-reading ex-1120

Download the program into PLC, and choose "Monitoring/Simulator" > "PLC Transmission" from the menu bar. After downloading, switch PLC to monitoring mode to monitor the communication status between PLC and EX-1120, as shown in Figure 5-7-35.

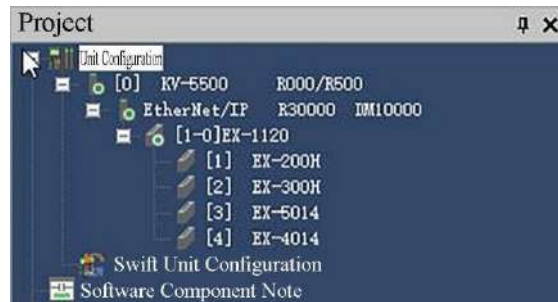

Figure 5-7-36 Monitoring the communication between PLC and EX-1120

5.8 Connection between EX-1121 and PLC

5.8.1 Connection and Configuration between Machine Expert and EX-1121

Note:

- (1) The EX-1121 has two modes: special mode and normal mode. The special mode can only be used with Keens CPU, and the factory default is normal mode.
- ② The ex-1121 works in BOOTP mode by default and does not have an IP address. [For details about how to set the IP address, see 6.3.6 SETTING the IP Address of the EX-1121 Adapter.](#)
- ③ In common mode, the input and output bytes of communication between THE IO module and EtherNet/IP are configured on the right of ex-1121

If the ex-1121 has only input or output modules on the right, the output (O->T) byte length is set to 1Byte or the input (T->O) byte length is set to 1Byte. If neither I/O module is available, the input (T->O) byte length and output (O->T) byte length are set to 1Byte.

The hardware configuration	Input (T->O) bytes	Output (O->T) bytes
EX-1121	1	1
EX-1121 EX-200H	2	1
EX-1121 EX-300H	1	2
EX-1121 EX-200H EX-300H	2	2

1. Communication connection diagram, as shown in Figure 5-8-1

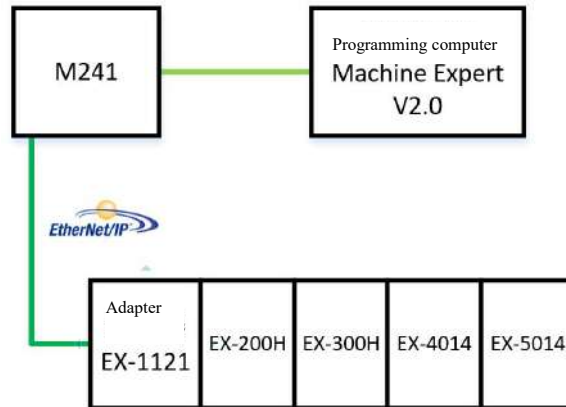

Figure 5-8-1 Communication connection diagram

2. Table 5-7-1 shows the hardware configuration

Table 5-8-1 Hardware configuration table

hardware	Quantity	note
Computer programming	1	Install Machine Expert V2.0
PLC	1	M241
EX-1121	1	EtherNet/IP adapter
EX-200H	1	Digital quantity input module
EX-300H	1	Digital output module
EX-4014	1	Analog input module
EX-5014	1	Analog output module

3. Set the IP address

[For details about how to set the IP address, see 6.3.6 SETTING the IP Address of the EX-1121 Adapter.](#)

4. Install the EDS file

On the menu bar, choose Tools > Device Repository. In the device Repository window, choose Install, as shown in Figure 5-7-2. In the EDS folder, select EX-1121_V1.1 and confirm the installation.

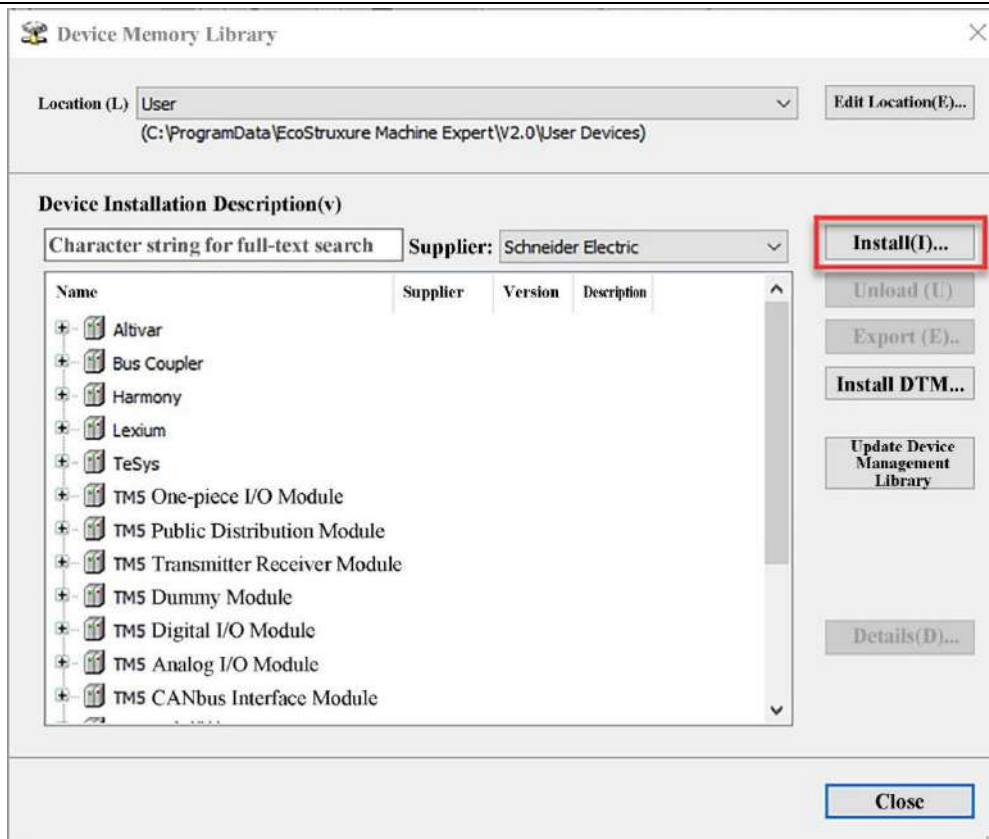

Figure 5-8-2 Installing the EDS file

5. New project and equipment configuration

Start Machine Expert V2.0, create a project, right-click "EtherNET_1" in the device tree, and choose "Add Device", as shown in Figure 5-8-3.

Choose Protocol Manager > Industrial Ethernet Manager in the Add Device window, as shown in Figure 5-8-4. Right-click "_ (Industrial Ethernet Manager)" > Add Device in the device window. Select DECOWELL AUTOMATION CO.,LTD for the supplier and ex-1121 in the equipment catalog, as shown in Figure 5-8-5.

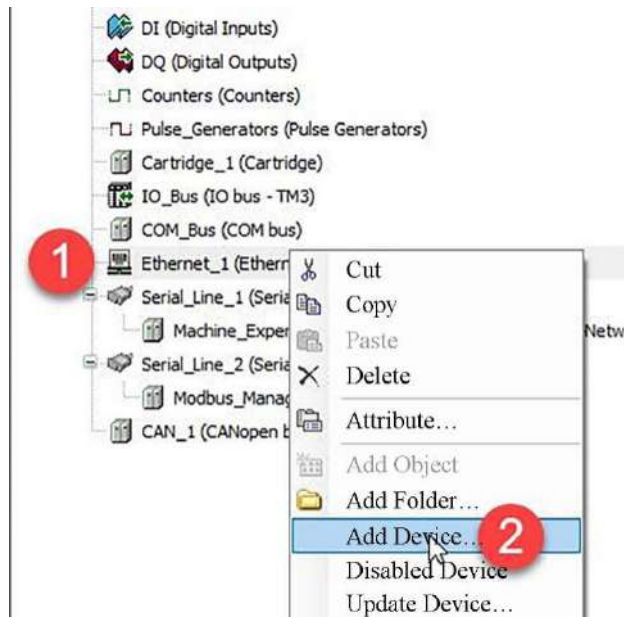

Figure 5-8-3 Adding devices



Figure 5-8-4 Adding industrial Ethernet manager

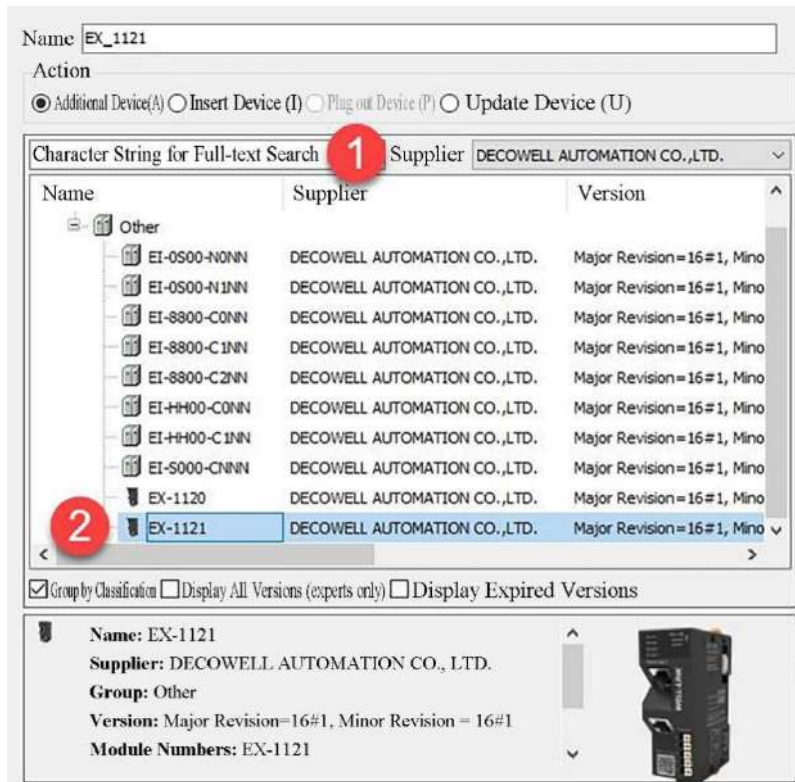

Figure 5-8-5 Adding ex-1121

To configure ex-1121 parameters, double-click EX-1121 in the device tree, and set the IP address to a fixed IP address, as shown in Figure 5-8-6.

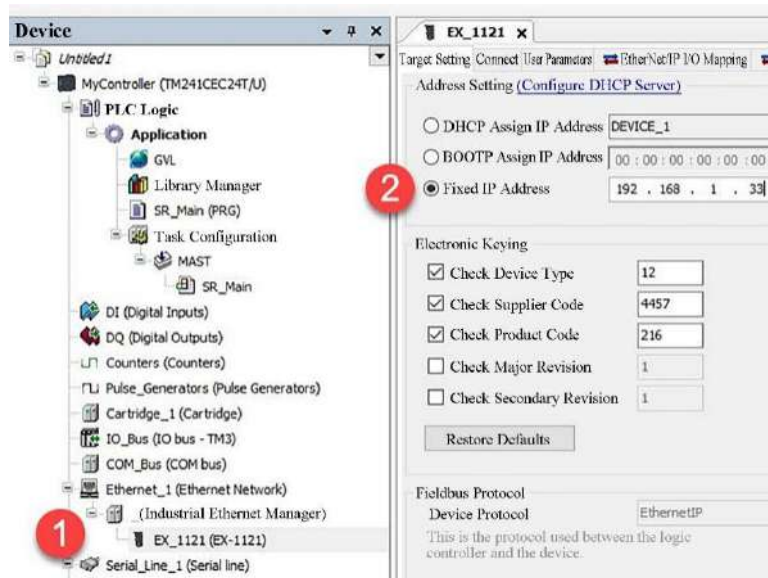

Figure 5-8-6 Configuring the IP address

Number of bytes occupied by computing modules:

Table 5-8-2 Number of bytes occupied by modules

The module type	Quantity	Input/output type	Occupied bytes
EX-2xx8	1	Input (T->O)	2
EX-2xxH	1	Input (T->O)	2
EX-2xxS	1	Input (T->O)	4
EX-3xx8	1	Output (O->T)	2
EX-3xxH	1	Output (O->T)	2
EX-3xxS	1	Output (O->T)	4
EX-4xx4	1	Input (T->O)	8
EX-4xx8	1	Input (T->O)	16
EX-5xx4	1	Output (O->T)	8
EX-5xx8	1	Output (O->T)	16

To configure connection parameters, double-click the default connection parameters, and set the output bytes (O->T) to 10 bytes and the input bytes (T->O) to 10 bytes in the edit connection window, as shown in Figure 5-8-7. View THE IO address mapping, as shown in Figure 5-8-8.

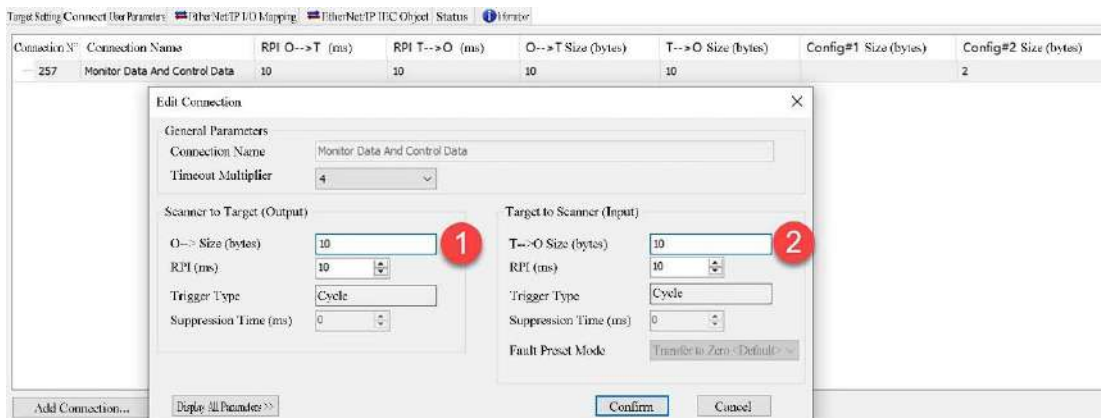

Figure 5-8-7 Configuring the input and output byte sizes

Variable	Mapping	Channel	Address	Type	Default Value	Unit	Description
		Input Monitor Data And Control Data	%IW7	ARRAY [0..4] OF WORD			
		Input Monitor Data And Control Data[0]	%IW7	WORD			
		Input Monitor Data And Control Data[1]	%IW8	WORD			
		Input Monitor Data And Control Data[2]	%IW9	WORD			
		Input Monitor Data And Control Data[3]	%IW10	WORD			
		Input Monitor Data And Control Data[4]	%IW11	WORD			
		Output Monitor Data And Control Data	%QW2	ARRAY [0..4] OF WORD			
		Output Monitor Data And Control Data[0]	%QW2	WORD			
		Output Monitor Data And Control Data[1]	%QW3	WORD			
		Output Monitor Data And Control Data[2]	%QW4	WORD			
		Output Monitor Data And Control Data[3]	%QW5	WORD			
		Output Monitor Data And Control Data[4]	%QW6	WORD			

Figure 5-8-8 IO address mapping

The physical address assignment corresponding to the actual module in the case:

Note: In actual hardware, the number of I/O modules configured for the EX-1121 adapter is the same as that of the model, but the sequence of the MODULES is different, and the physical address assignment for the modules is different, as shown in Figure 5-8-9, 5-8-10, and 5-8-11.

Adapter EX-1121	EX-200H	EX-300H	EX-4014	EX-5014
	IW0	QW0	IW1 IW2 IW3 IW4	QW1 QW2 QW3 QW4

Figure 5-7-9 I/O sorting and address assignment #1(application in case)

Adapter EX-1121	EX-4014	EX-5014	EX-200H	EX-300H
	IW0 IW1 IW2 IW3	QW0 QW1 QW2 QW3	IW4	QW4

Figure 5-7-10 I/O sorting and address assignment #2

Adapter EX-1120	EX-4014	EX-5014	EX-2008	EX-3008
	IW0 IW1 IW2 IW3	QW0 QW1 QW2 QW3	IW4	QW4

Figure 5-7-11 I/O sorting and address assignment #3

Note: the 8-channel digital input/output module occupies one word. The 8-channel module address is used in the corresponding physical address

Low bytes correspond to 8 bits.

In EtherNet/IP I/O mapping will always update variable to choose "enable 2 (always in the bus cycle task)", and download the program to PLC, and monitor the PLC running status and I/O mapping address.

5.8.2 Connection and Configuration between CODESYS and EX-1121

Note:

(1) The EX-1121 has two modes: special mode and normal mode. The special mode can only be used with Keens CPU, and the factory default is normal mode.

② The ex-1121 works in BOOTP mode by default and does not have an IP address. [For details about how to set the IP address, see 6.3.6 SETTING the IP Address of the EX-1121 Adapter.](#)

③ In common mode, the input and output bytes of communication between THE IO module and EtherNet/IP are configured on the right of ex-1121

If the ex-1121 has only input or output modules on the right, the output (O->T) byte length is set to 1Byte or the input (T->O) byte length is set to 1Byte. If neither I/O module is available, the input (T->O) byte length and output (O->T) byte length are set to 1Byte.

The hardware configuration	Input (T->O) bytes	Output (O->T) bytes
EX-1121	1	1
EX-1121 EX-200H	2	1
EX-1121 EX-300H	1	2
EX-1121 EX-200H EX-300H	2	2

1. Communication connection diagram, as shown in Figure 5-8-12

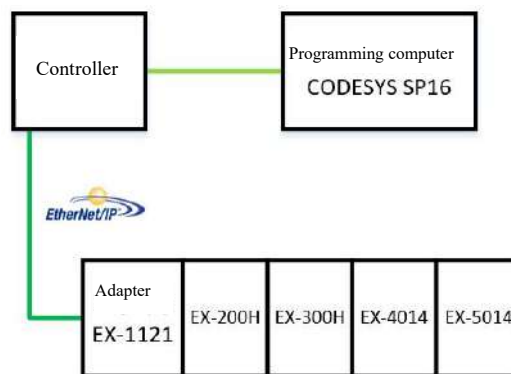

Figure 5-8-12 Communication connection diagram

2. Table 5-8-3 shows the hardware configuration

Table 5-8-3 Hardware configuration table

hardware	Quantity	note
Computer programming	1	Install the CODESYS SP16
The controller	1	

EX-1121	1	EtherNet/IP adapter
EX-200H	1	Digital quantity input module
EX-300H	1	Digital output module
EX-4014	1	Analog input module
EX-5014	1	Analog output module

3. Set the IP address

For details about how to set the IP address, see 6.3.6 SETTING the IP Address of the EX-1121 Adapter.

4. Install the EDS file

On the menu bar, choose Tools > Device Repository. In the device repository window, choose Install, as shown in Figure 5-8-13. In the EDS folder, select EX-1121_V1.1 and confirm the installation.

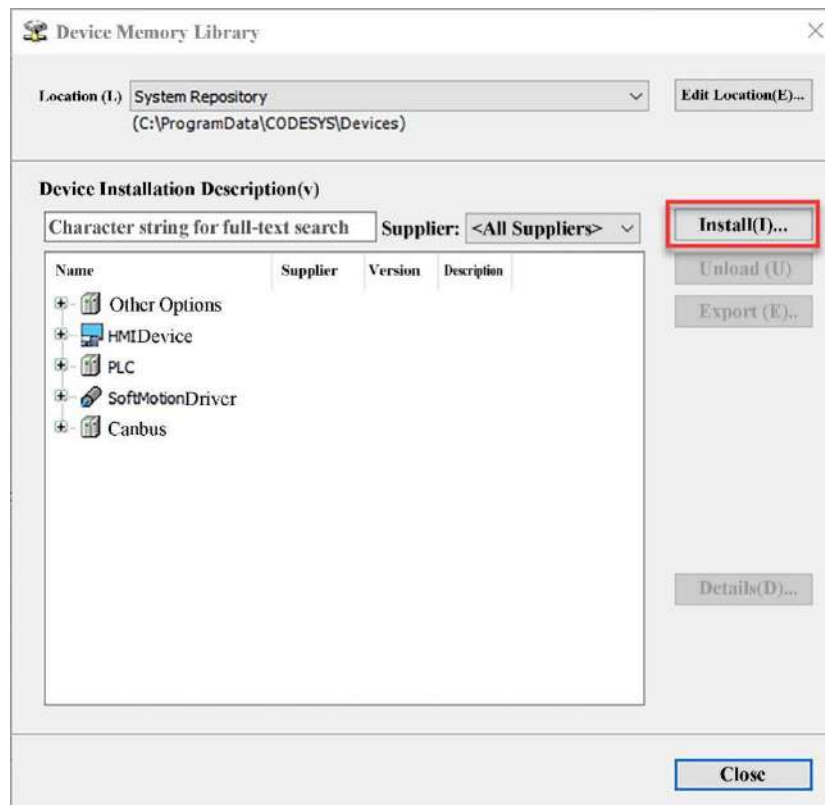

Figure 5-8-13 Installing the EDS file

5. New project and equipment configuration

Open CODESYS SP16, create a project, right-click Device in the Device tree, and choose Add Device. In the add Device window, choose Ethernet, as shown in Figure 5-8-14.

Right-click Ethernet in the device tree and choose Add Device. In the add Device window, choose Ethernet /IP Scanner, as shown in Figure 5-8-15.



Figure 5-8-14 Adding an Ethernet adapter

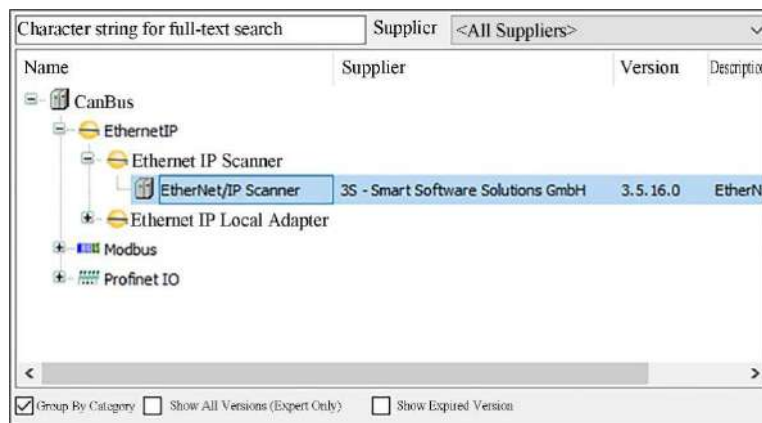

Figure 5-8-15 Adding the EthernetIP scanner

To configure the network adapter, double-click Ethernet in the device tree and select the network adapter to communicate with Ethernet /IP slave, as shown in Figure 5-8-16.

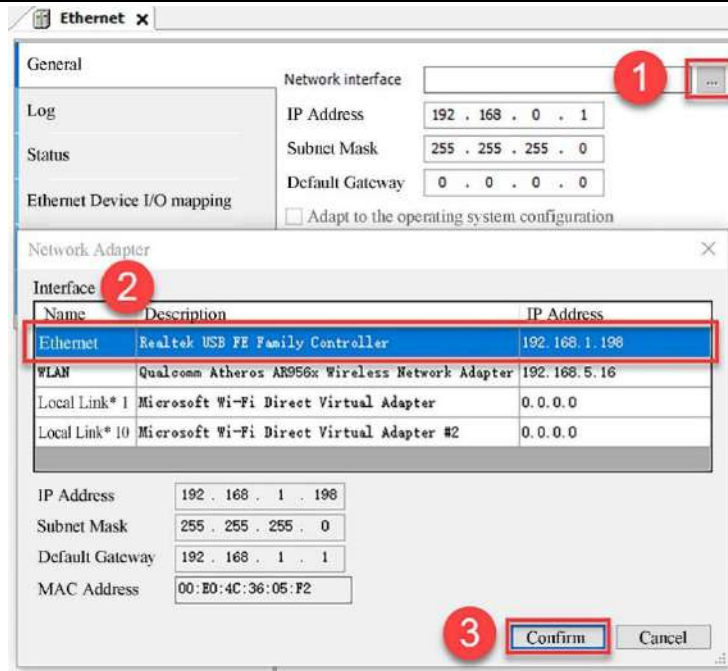

Figure 5-8-16 Configuring the network adapter for the Ethernet adapter

Right-click EtherNet_IP_Scanner in the device tree and choose Add Device. In the add device window, select EX-1121, as shown in Figure 5-8-17.

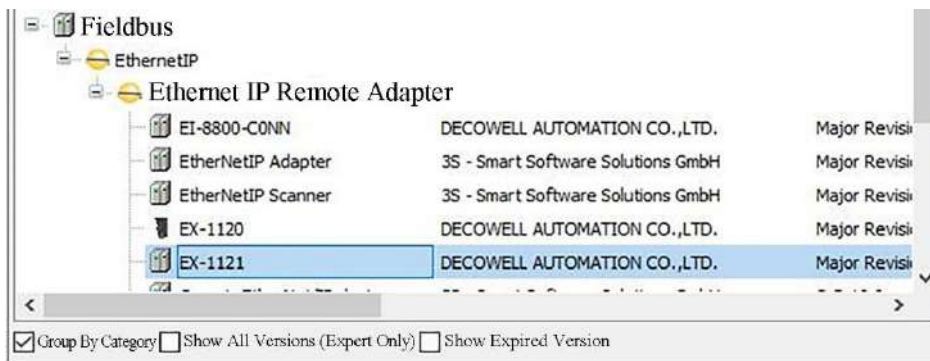

Figure 5-7-17 Adding the EX-1121 adapter

To configure the IP address of the EX-1121 adapter, double-click EX_1121 in the device tree, and enter the IP address (the IP address must be the same as that of the actual module), as shown in Figure 5-8-18.

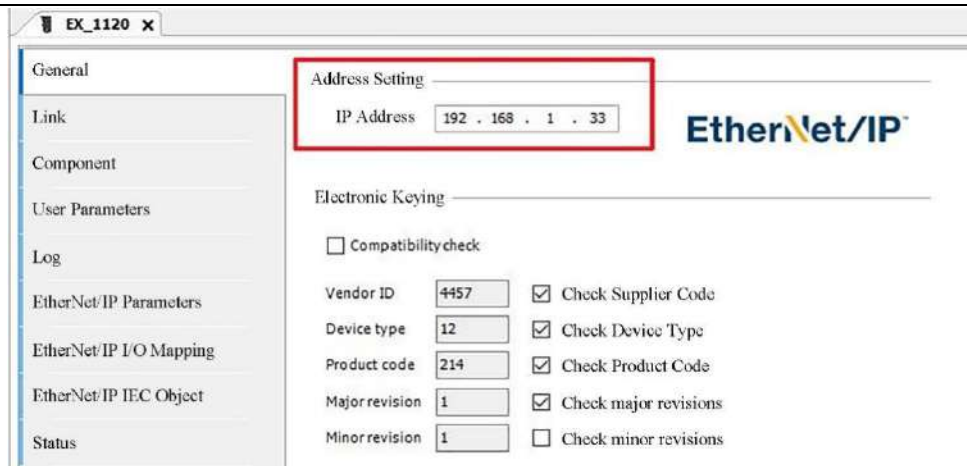

Figure 5-8-18 Configuring the IP address of the EX-1121 adapter

Number of bytes occupied by computing modules:

Table 5-8-4 Number of bytes occupied by modules

The module type	Quantity	Input/output type	Occupied bytes
EX-2xx8	1	Input (T->O)	2
EX-2xxH	1	Input (T->O)	2
EX-2xxS	1	Input (T->O)	4
EX-3xx8	1	Output (O->T)	2
EX-3xxH	1	Output (O->T)	2
EX-3xxS	1	Output (O->T)	4
EX-4xx4	1	Input (T->O)	8
EX-4xx8	1	Input (T->O)	16
EX-5xx4	1	Output (O->T)	8
EX-5xx8	1	Output (O->T)	16

Set the input and output bytes of the I/O module of the EX-1121 adapter (you need to set the input and output bytes based on the actual NUMBER of I/O modules to ensure normal communication), as shown in Figure 5-8-19. Then view the I/O mapping of EtherNet/IP communication, as shown in Figure 5-8-20.

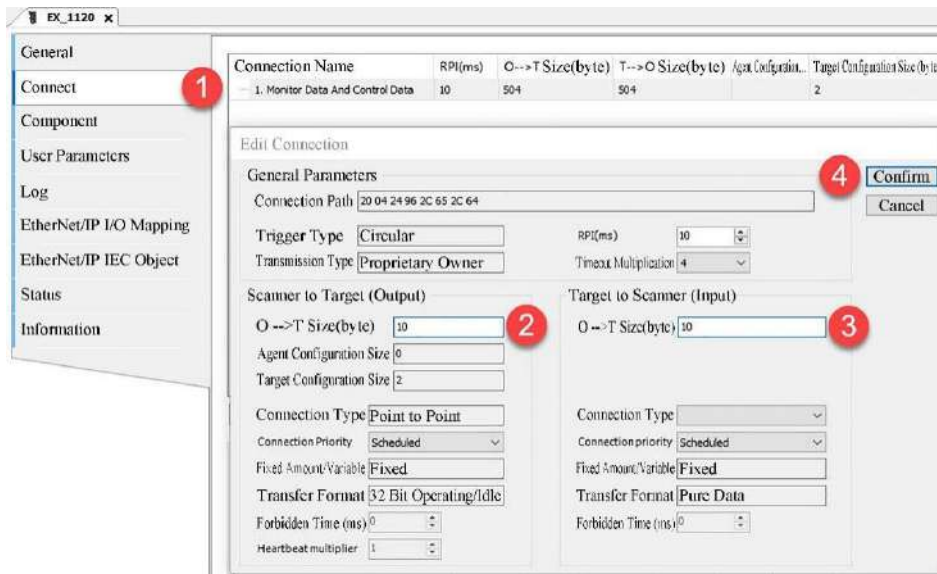

Figure 5-8-19 Configuring the size of input and output bytes

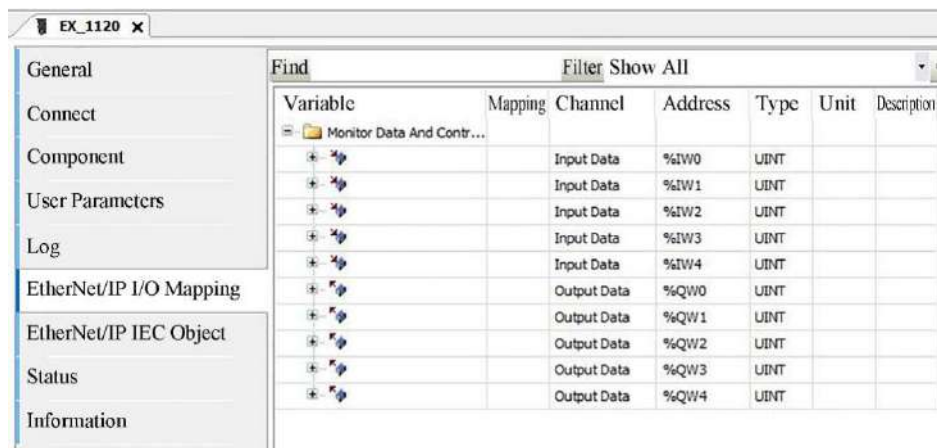

Figure 5-8-20 IO address mapping

The physical address assignment corresponding to the actual module in the case:

Note: In actual hardware, the number of I/O modules configured for the EX-1121 adapter is the same as that of the model, but the sequence of the MODULES is different, and the physical address assignment for the modules is different, as shown in Figure 5-8-21, 5-8-22, and 5-8-23.

Adapter	EX-200H	EX-300H	EX-4014	EX-5014
EX-1121				
	IW0	QW0	IW1	QW1
			IW2	QW2
			IW3	QW3
			IW4	QW4

Figure 5-8-21 I/O sorting and address assignment #1(case application)

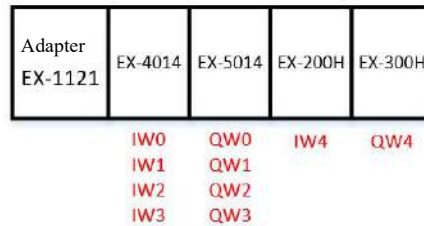

Figure 5-8-22 I/O sorting and address assignment #2

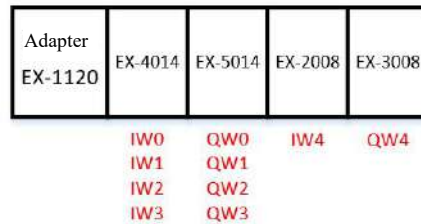

Figure 5-8-23 I/O sorting and address assignment #3

Note: the 8-channel digital input/output module occupies one word. The 8-channel module address is used in the corresponding physical address

Low bytes correspond to 8 bits.

In EtherNet/IP I/O mapping will always update variable to choose "enable 2 (always in the bus cycle task)", and download the program to PLC, and monitor the PLC running status and I/O mapping address.

5.8.3 Connection and Configuration between Sysmac Studio and EX-1121

Note:

Note:

(1) The EX-1121 has two modes: special mode and normal mode. The special mode can only be used with Keens CPU, and the factory default is normal mode.

(2) The ex-1121 works in BOOTP mode by default and does not have an IP address. [For details about how to set the IP address, see 6.3.6 SETTING the IP Address of the EX-1121 Adapter.](#)

(3) In common mode, the input and output bytes of communication between THE IO module and EtherNet/IP are configured on the right of ex-1121

If the ex-1121 has only input or output modules on the right, the output (O->T) byte length is set to 1Byte or the input (T->O) byte length is set to 1Byte. If neither I/O module is available, the input (T->O) byte length and output (O->T) byte length are set to 1Byte.

The hardware configuration	Input (T->O) bytes	Output (O->T) bytes
EX-1121	1	1

EX-1121 EX-200H	2	1
EX-1121 EX-300H	1	2
EX-1121 EX-200H EX-300H	2	2

1. Communication connection diagram, as shown in Figure 5-8-24

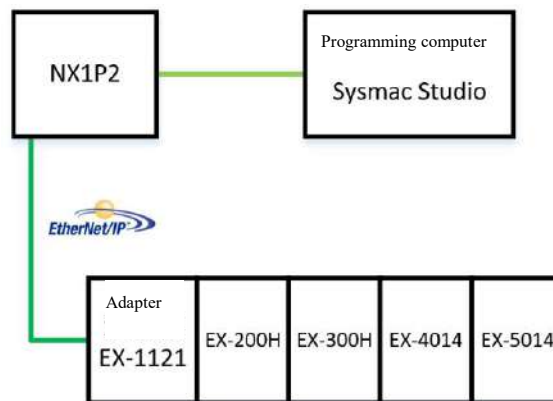

Figure 5-8-24 Communication connection diagram

2. Table 5-8-5 shows the hardware configuration

Table 5-8-5 Hardware configuration table

hardware	Quantity	Note
Computer programming	1	Install the Sysmac Studio
NX1P2	1	
EX-1121	1	EtherNet/IP adapter
EX-200H	1	Digital quantity input module
EX-300H	1	Digital output module
EX-4014	1	Analog input module
EX-5014	1	Analog output module

3. Set the IP address

[For details about how to set the IP address, see 6.3.6 SETTING the IP Address of the EX-1121 Adapter.](#)

4. New project and equipment configuration

Open the Sysmac Studio programming software creation project and configure the EtherNet/IP port as a fixed IP address (the same as the ACTUAL PLC port IP address), as shown in Figure 5-8-25.



Figure 5-8-25 EtherNet/IP port Settings

Create all variables, and create input and output variables in global variables. The length of the variables must be the same as the length of input and output bytes in the actual module, as shown in Figure 5-8-26.

Number of bytes occupied by computing modules:

Table 5-8-6 Number of bytes occupied by modules

The module type	Quantity	Input/output type	Occupied bytes
EX-2xx8	1	Input (T->O)	2
EX-2xxH	1	Input (T->O)	2
EX-2xxS	1	Input (T->O)	4
EX-3xx8	1	Output (O->T)	2
EX-3xxH	1	Output (O->T)	2
EX-3xxS	1	Output (O->T)	4
EX-4xx4	1	Input (T->O)	8
EX-4xx8	1	Input (T->O)	16
EX-5xx4	1	Output (O->T)	8
EX-5xx8	1	Output (O->T)	16

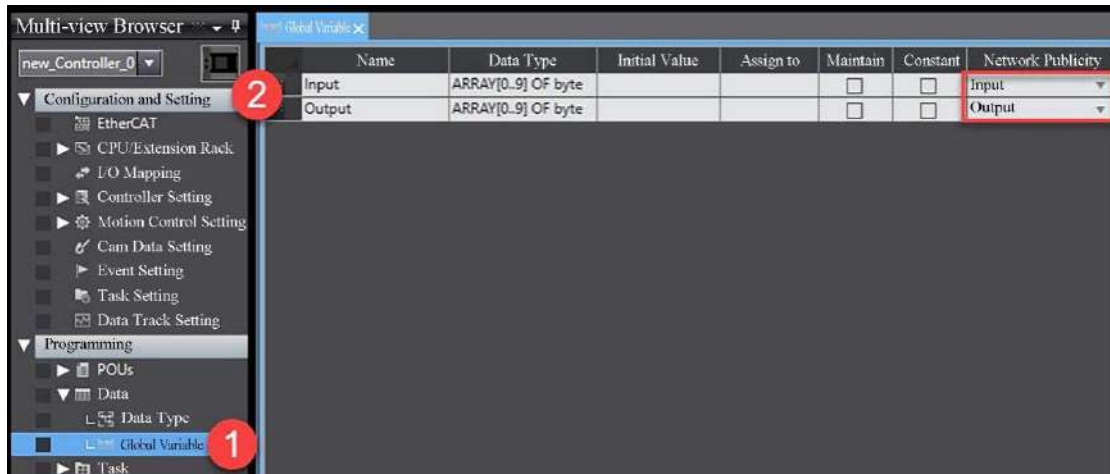

Figure 5-8-26 Creating global variables

On the menu bar, choose Tools > EtherNet/IP Connection Settings. In the EtherNet/IP list window, double-click the node address to open the EtherNet/IP port connection Settings window, as shown in Figure 5-8-27.

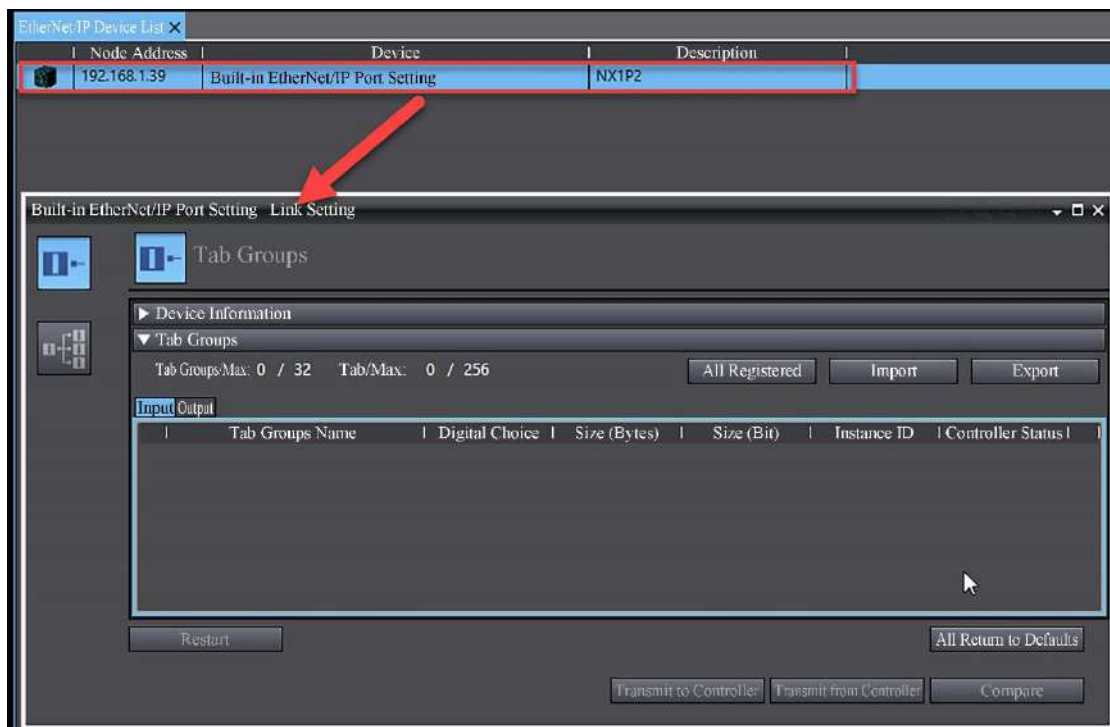

Figure 5-8-27 Opening the connection Settings window for built-in EtherNet/IP port Settings

Register variables. In the built-in EtherNet/IP port Settings connection Settings window, select "Label Groups" window and click "Register All" to register the newly created global variables, as shown in Figure 5-8-28.

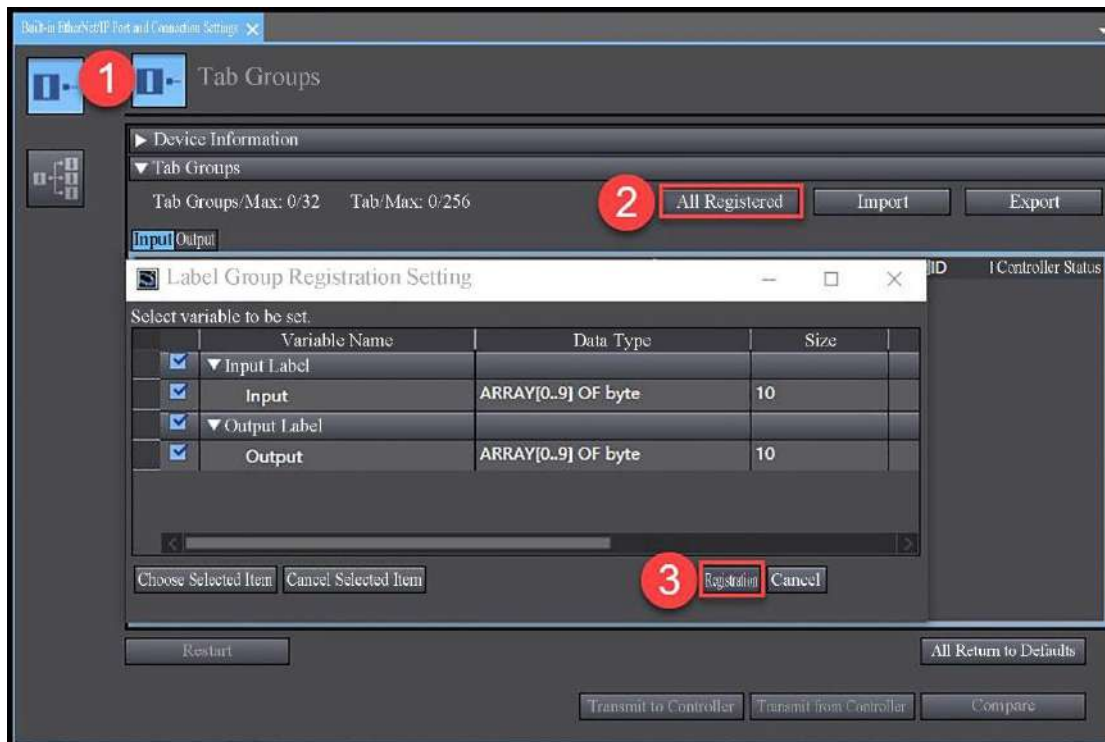

Figure 5-8-28 Registry variables

Install the EDS file, right-click in the blank area of the toolbox on the right of the connection setting window of the built-in Ethernet/IP port, and choose Show EDS Library, as shown in Figure 5-8-29. In the EDS library window, click Install to open the EDS file to be installed, as shown in Figure 5-8-30.

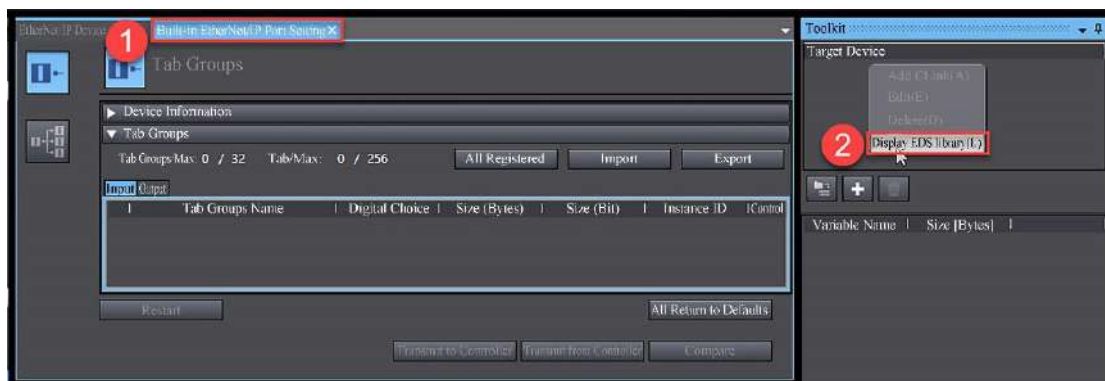

Figure 5-8-29 shows the EDS library

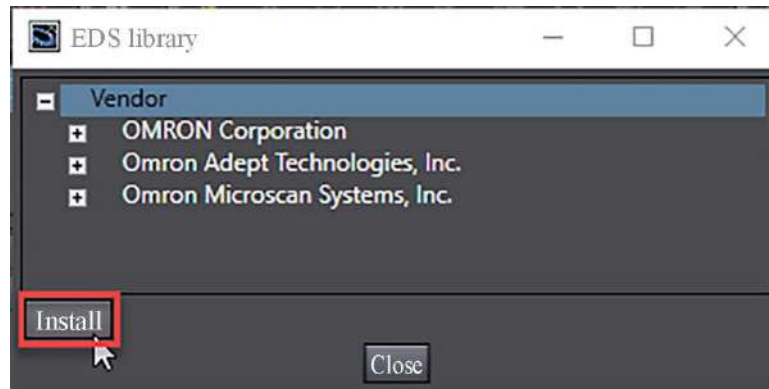

Figure 5-8-30 Installing the EDS file

To add devices to be communicated with and set parameters, select "Add Target Device" in the toolbox, as shown in Figure 5-8-31. Fill in the IP address of EtherNet/IP slave, slave model, and revised version, and click "Add" in the lower left corner of the motor.

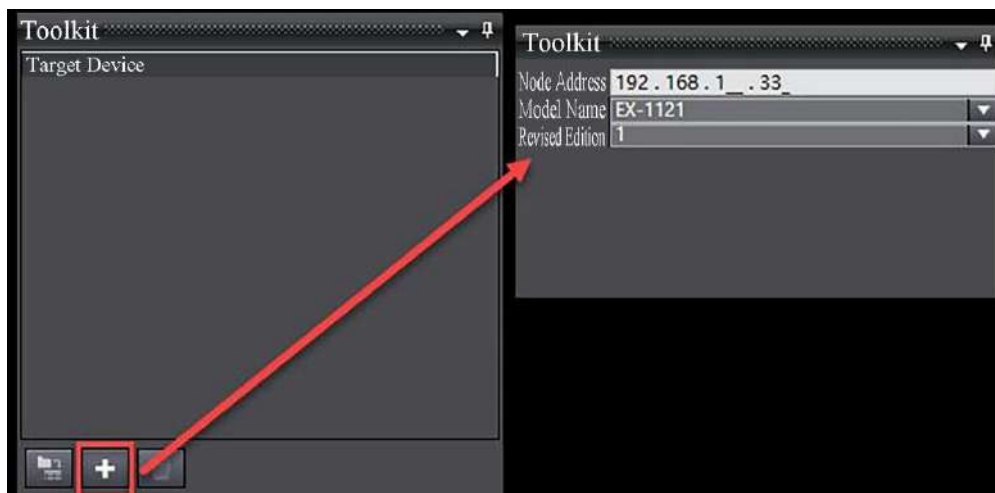

Figure 5-7-31 Adding a target device

Drag the target device 192.168.1.33 EX-1121 version 1 from the toolbox to the connection, as shown in Figure 5-8-32.

Set the target device parameters. The input target variable of EX-1121 is 100, the output target variable is 101, the input and output bytes are 10, and the starting variable is the global variable registered, as shown in Figure 5-8-33.

Switch PLC to online, switch PLC to programming mode, and then select "Send to Controller", as shown in FIG. 5-8-34;

Transfer PLC online, and then download the program into PLC. IO module sequencing corresponds to the actual address, as shown in Figure 5-8-35 and 5-8-36.

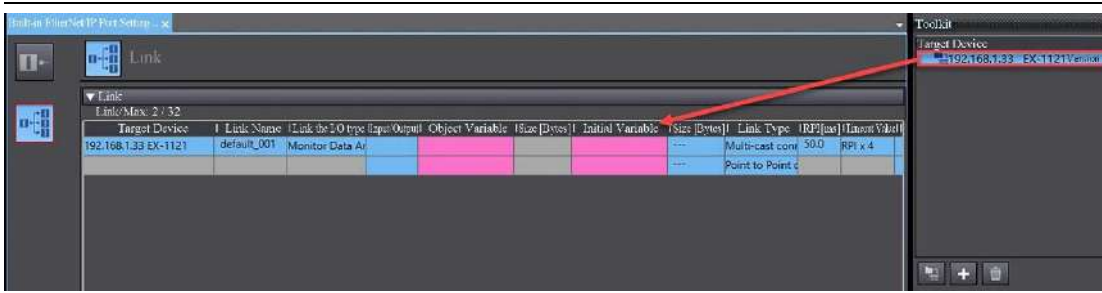

Figure 5-8-32 Adding a connected device



Figure 5-8-33 Setting target device parameters

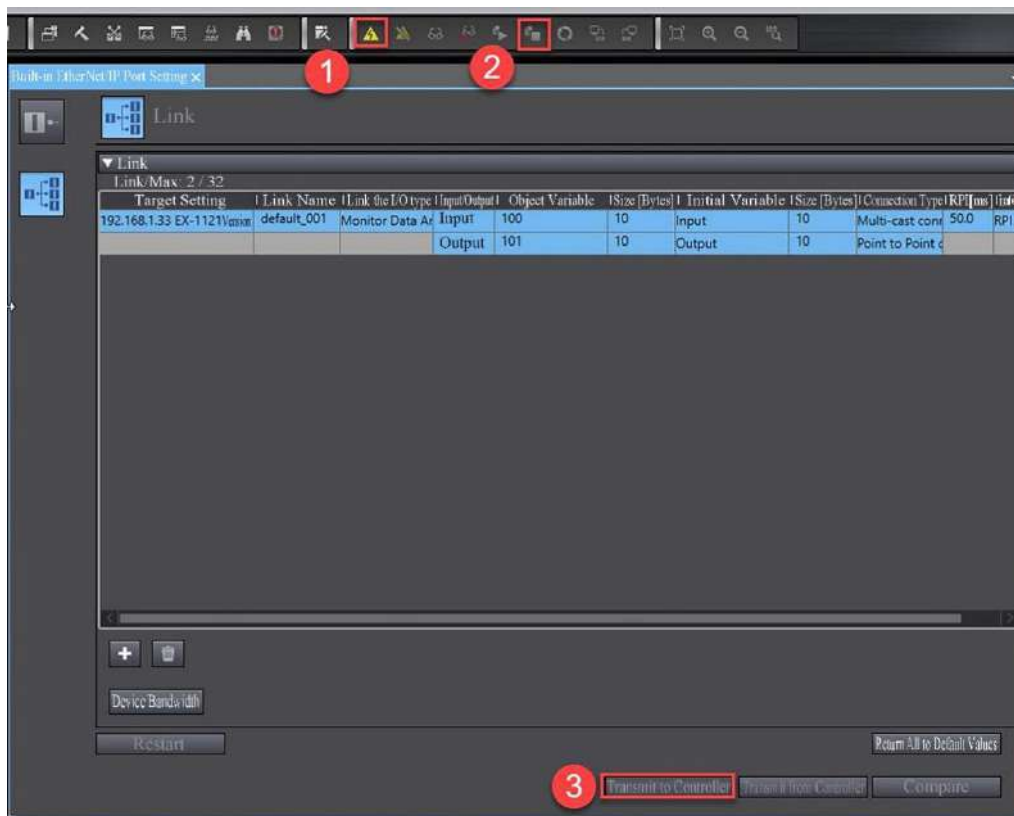

Figure 5-8-34 Transferring the EtherNet/IP configuration to the controller

Channel/module	EX-1121	EX-200H	EX-300H	EX-4014	EX-5014
Channel 0	-	Input[0][1]	Output[0][1]	Input[2] [3]	Output [2][3]
Channel 1	-	-	-	Input[4] [5]	Output[4][5]

Channel 2	-	-	-	Input[6][7]	Output[6] [7]
Channel 3	-	-	-	Input[8][9]	Output[8][9]

Figure 5-8-35 Correspondence between IO module sequencing and actual address (application in case)

Channel/module	EX-1121	EX-4014	EX-5014	EX-200H	EX-300H
Channel 0	-	Input[0][1]	Output[0][1]	Input[8] [9]	Outputf[8][9]
Channel 1	-	Input[2] [3]	Output[4][5]	-	-
Channel 2	-	Input[4] [5]	Output[6] [7]	-	-
Channel 3	-	Input[6][7]	Output[8][9]	-	-

Figure 5-8-36 Mapping between I/O module sequencing and actual addresses

5.8.4 Connection and Configuration between RSLogix 5000 and Ex-1121

Note:

(1) The EX-1121 has two modes: special mode and normal mode. The special mode can only be used with Keens CPU, and the factory default is normal mode.

② The ex-1121 works in BOOTP mode by default and does not have an IP address. [For details about how to set the IP address, see 6.3.6 SETTING the IP Address of the EX-1121 Adapter.](#)

③ In common mode, the input and output bytes of communication between THE IO module and EtherNet/IP are configured on the right of ex-1121

If the ex-1121 has only input or output modules on the right, the output (O-->T) byte length is set to 1Byte or the input (T->O) byte length is set to 1Byte. If neither I/O module is available, the input (T->O) byte length and output (O->T) byte length are set to 1Byte.

The hardware configuration	Input (T->O) bytes	Output (O->T) bytes
EX-1121	1	1
EX-1121 EX-200H	2	1
EX-1121 EX-300H	1	2
EX-1121 EX-200H EX-300H	2	2

1. Communication connection diagram, as shown in Figure 5-8-37

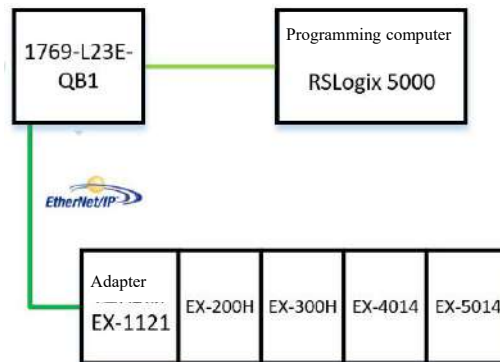

Figure 5-8-37 Communication connection diagram

2. Table 5-8-7 shows the hardware configuration

Table 5-8-7 Hardware configuration table

hardware	Quantity	note
Computer programming	1	Install RSLogix 5000
PLC	1	1769-L23E-QB1
EX-1121	1	EtherNet/IP adapter
EX-200H	1	Digital quantity input module
EX-300H	1	Analog output module
EX-4014	1	Analog input module
EX-5014	1	Analog output module

3. Set the IP address

[For details about how to set the IP address, see 6.3.6 SETTING the IP Address of the EX-1121 Adapter.](#)

4. Install the EDS file

On the menu bar, choose Tools > EDS Hardware Installation Tool, as shown in Figure 5-8-38. In the EDS installation window, select the specified folder, as shown in Figure 5-8-39.

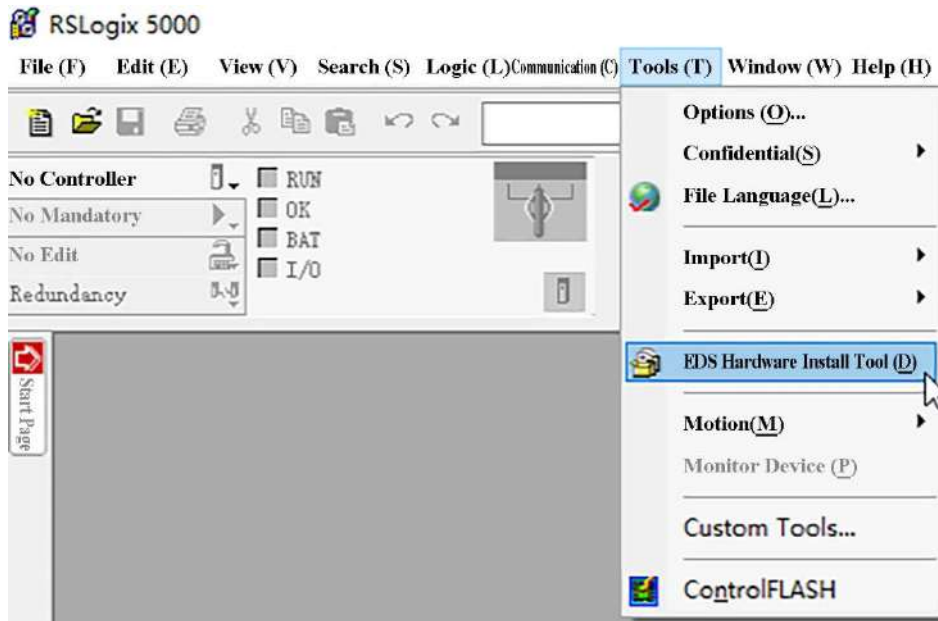

Figure 5-8-38 Installing the EDS file

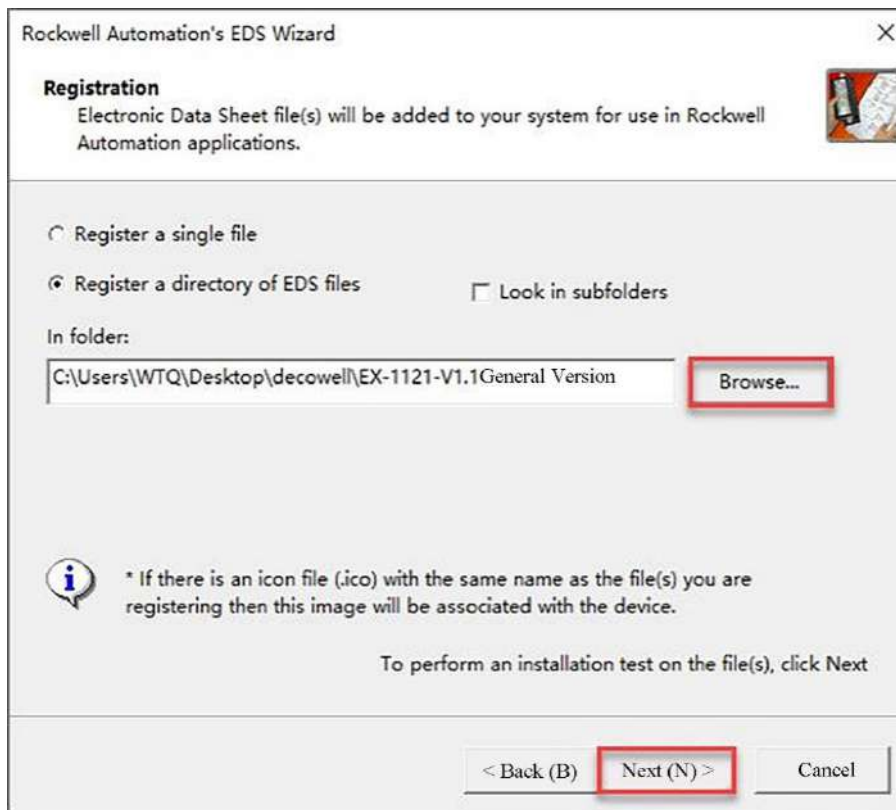

Figure 5-8-39 Selecting the EDS folder path

5. New project and equipment configuration

Open RSLogix 5000, select a new project, and select the corresponding CPU and version, as shown in Figure 5-8-40.

FIG. 5-8-40 New construction project

Configuration EtherNet/IP communication, in Controller Manager, select EtherNet and right click New Module, as shown in Figure 5-8-41.

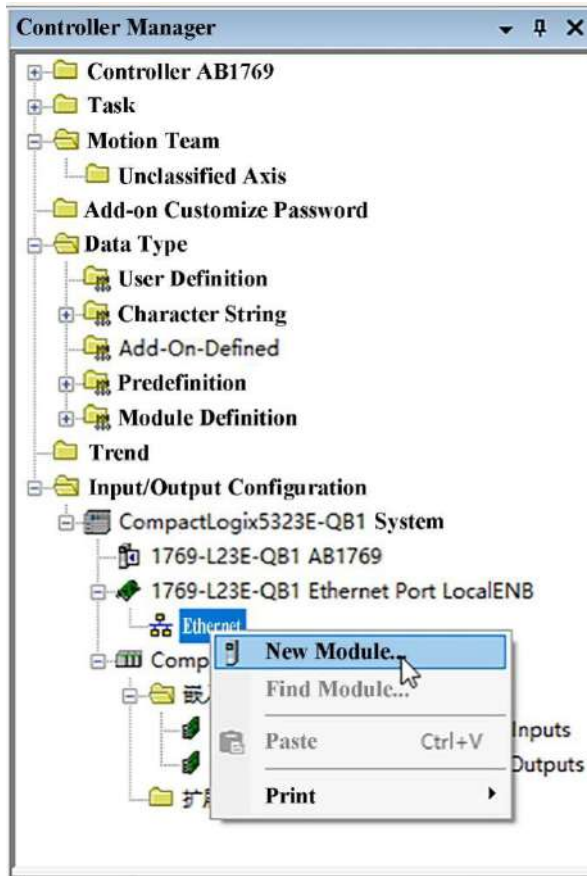

Figure 5-8-41 Creating a Module

Add IO module, select DECOWELL in filter, and select the actual IO module model, as shown in Figure 5-8-42.

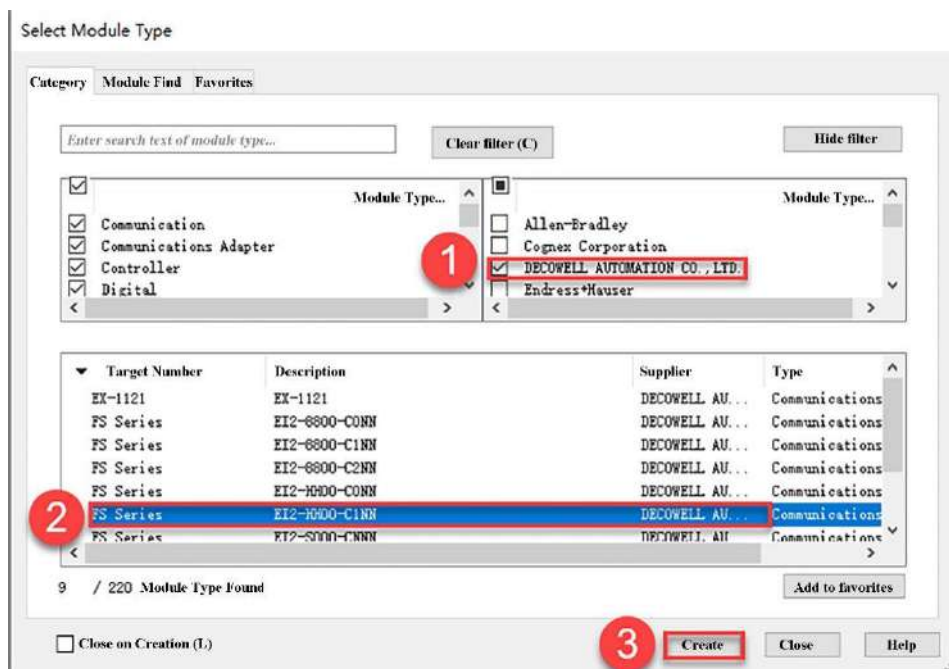

Figure 5-8-42 Selecting the IO module

Configure the module name and IP address. The IP address must be the same as the actual IP address. Otherwise, the communication fails, as shown in Figure 5-8-43.

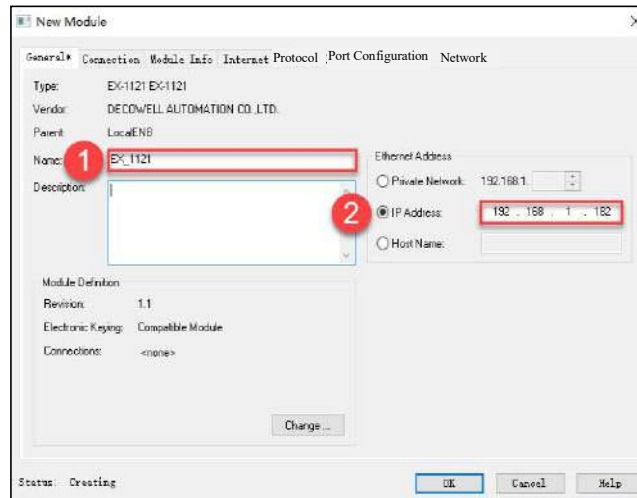

Figure 5-8-43 Edit module IP and name

In the New Module window, select Change to set the INPUT and output bytes of the EX-1121 (the number of bytes must be the same as the actual I/O Module; otherwise, the COMMUNICATION fails), as shown in Figure 5-8-44.

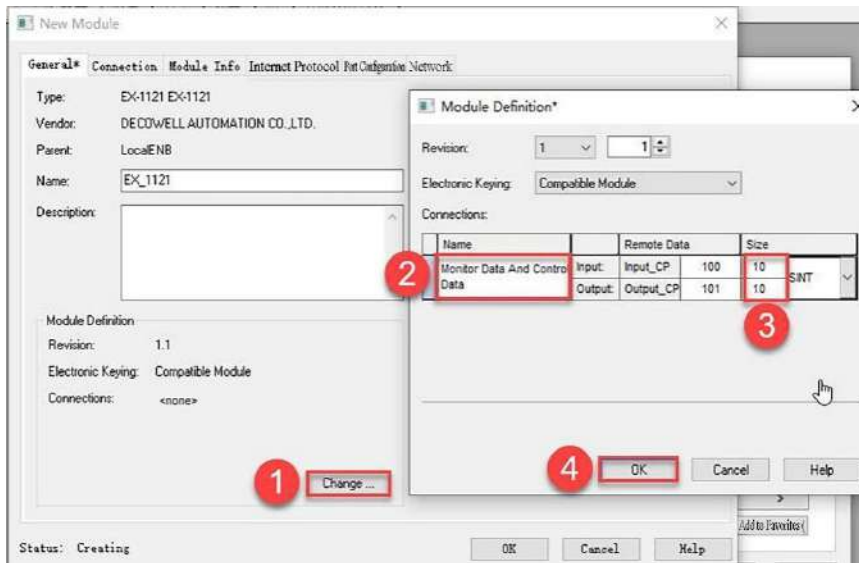

Figure 5-8-44 Configuration module input and output bytes

Number of bytes occupied by computing modules:

Table 5-8-8 Number of bytes occupied by modules

The module type	Quantity	Input/output type	Occupied bytes
-----------------	----------	-------------------	----------------

EX-2xx8	1	Input (T->O)	2
EX-2xxH	1	Input (T->O)	2
EX-2xxS	1	Input (T->O)	4
EX-3xx8	1	Output (O->T)	2
EX-3xxH	1	Output (O->T)	2
EX-3xxS	1	Output (O->T)	4
EX-4xx4	1	Input (T->O)	8
EX-4xx8	1	Input (T->O)	16
EX-5xx4	1	Output (O->T)	8
EX-5xx8	1	Output (O->T)	16

Choose to communicate with the online PLC and download the program, choose "Communication" > "Activity" from the menu bar, select the online CPU, as shown in Figure 5-8-45, and download the program into the PLC, as shown in Figure 5-8-46.

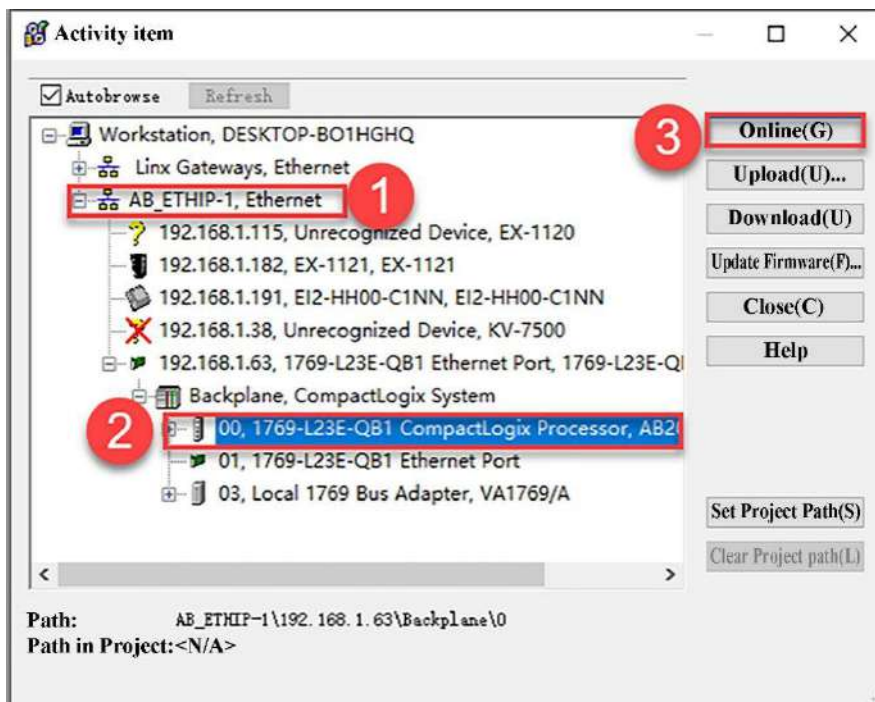

Figure 5-8-45 Choosing to communicate with online PLC

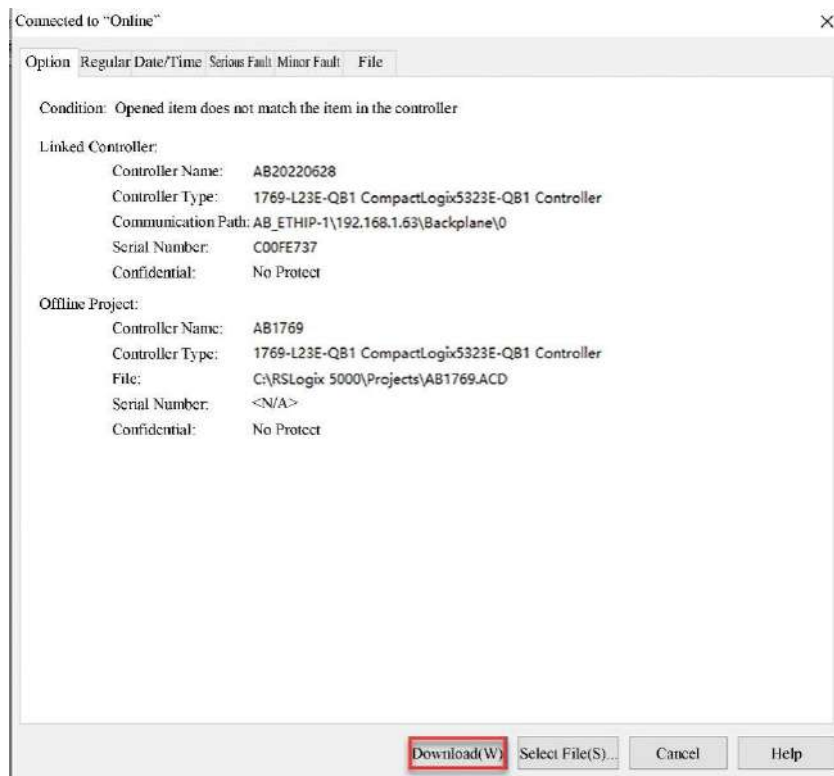

Figure 5-8-46 Program downloaded into PLC

Monitor whether the communication is normal, bring the CPU online, and monitor whether the communication between EX-1121 and PLC is normal, as shown in Figure 5-8-47.

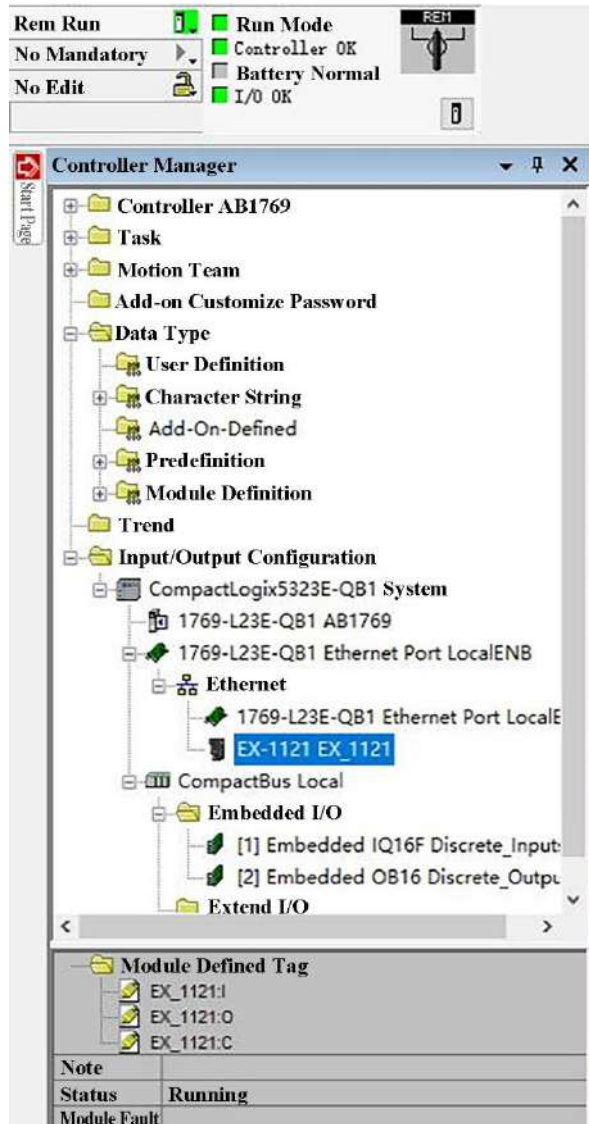

Figure 5-8-47 Monitoring module running status

5.8.5 Connection and Configuration between KV STUDIO and EX-1121

Note:

- (1) The EX-1121 has two modes: special mode and normal mode. The special mode can only be used with Keens CPU, and the factory default is normal mode.
- ② The ex-1121 works in BOOTP mode by default and does not have an IP address. [For details about how to set the IP address, see 6.3.6 SETTING the IP Address of the EX-1121 Adapter.](#)
- ③ In common mode, the input and output bytes of communication between THE IO module and EtherNet/IP are configured on the right of ex-1121

If the ex-1121 has only input or output modules on the right, the output (O->T) byte length is set to 1Byte or the input (T->O) byte length is set to 1Byte. If neither I/O module is available, the input (T->O) byte length and output (O->T) byte length are set to 1Byte.

The hardware configuration	Input (T- >O) bytes	Output (O- >T) bytes
EX-1121	1	1
EX-1121 EX-200H	2	1
EX-1121 EX-300H	1	2
EX-1121 EX-200H EX-300H	2	2

1. Communication connection diagram, as shown in Figure 5-8-48

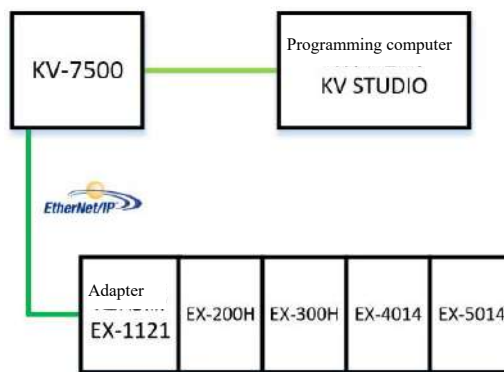

FIG. 5-8-48 Communication connection diagram

2. Table 5-8-9 shows the hardware configuration

Table 5-8-9 Hardware configuration table

hardware	Quantity	note
Computer programming	1	Install the KV STUDIO
PLC	1	KV-7500
EX-1121	1	EtherNet/IP adapter
EX-200H	1	Digital quantity input module
EX-300H	1	Analog output module
EX-4014	1	Analog input module
EX-5014	1	Analog output module

3. Set the IP address

[For details about how to set the IP address, see 6.3.6 SETTING the IP Address of the EX-1121 Adapter.](#)

4. Copy XML files

Copy all files in the "Keens Version" folder to the KV STUDIO software folder:

"C:\ProgramData\KEYENCE\KVS11G_Trial\KVS\EIP_Eds"

5. New project and equipment configuration

Open KV STUDIO software, create a new project, and double-click "EtherNet/IP" in the project device tree to open the EtherNet/IP Settings window, as shown in Figure 5-8-49.

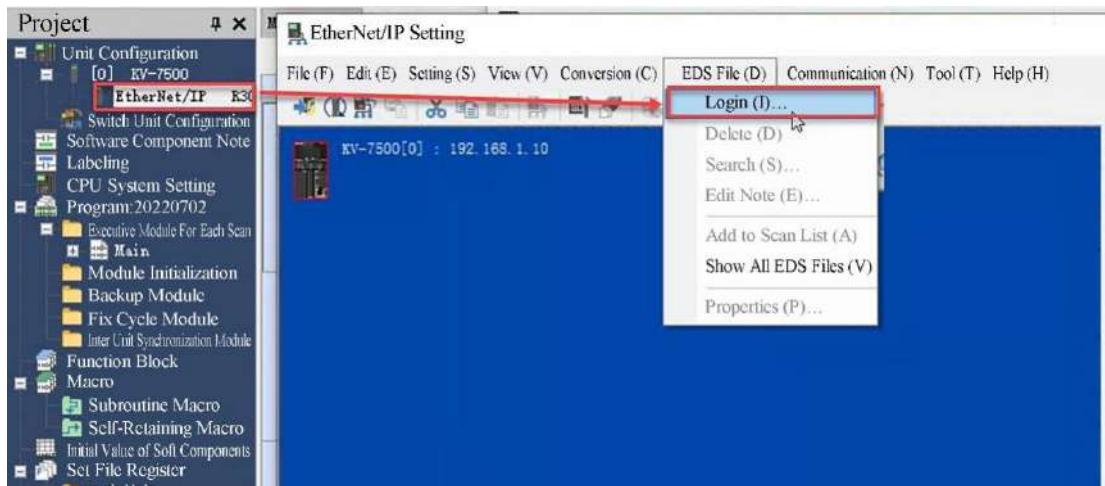

Figure 5-8-49 Opening the EtherNet/IP Settings window

Install the EDS file. On the menu bar of the EtherNet/IP configuration window, choose EDS File > Login. In the EDS folder, choose Common Version > EX-1121, as shown in Figure 5-8-50.

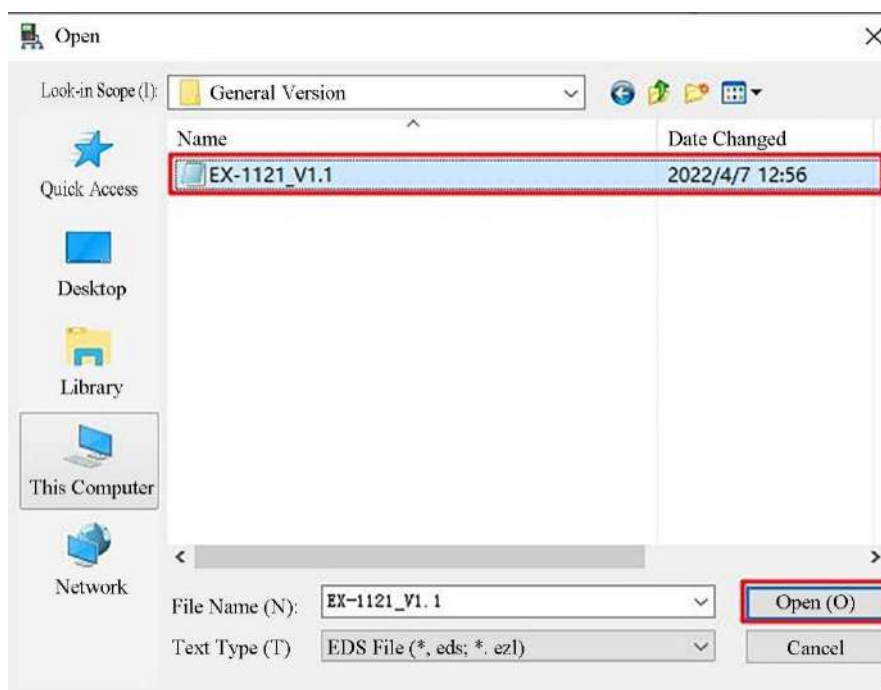

Figure 5-8-50 Installing the EDS file

Set the ex-1121 adapter mode to special PLC mode (the factory default is common mode). Right-click the blank area in the device Search option on the right and choose "Device Search", as shown in Figure 5-8-51.

Add the scanned devices to the scan list. Right-click the devices to be added and choose Add to scan List, as shown in Figure 5-8-52.

For transmission adapter Settings, right-click "EX-1121" in the device list and choose "Transmission Adapter Settings", as shown in Figure 5-8-53.

In the transfer adapter setting window, change the adapter No.100 setting value to "1: Special PLC" and write the adapter, as shown in Figure 5-8-54. After the writing is complete, the EX-1121 must be powered off and restarted.

In the EtherNet/IP Settings window, select KV-7500 and right click "Auto Configuration" to read ex-1121 again, as shown in Figure 5-8-55.

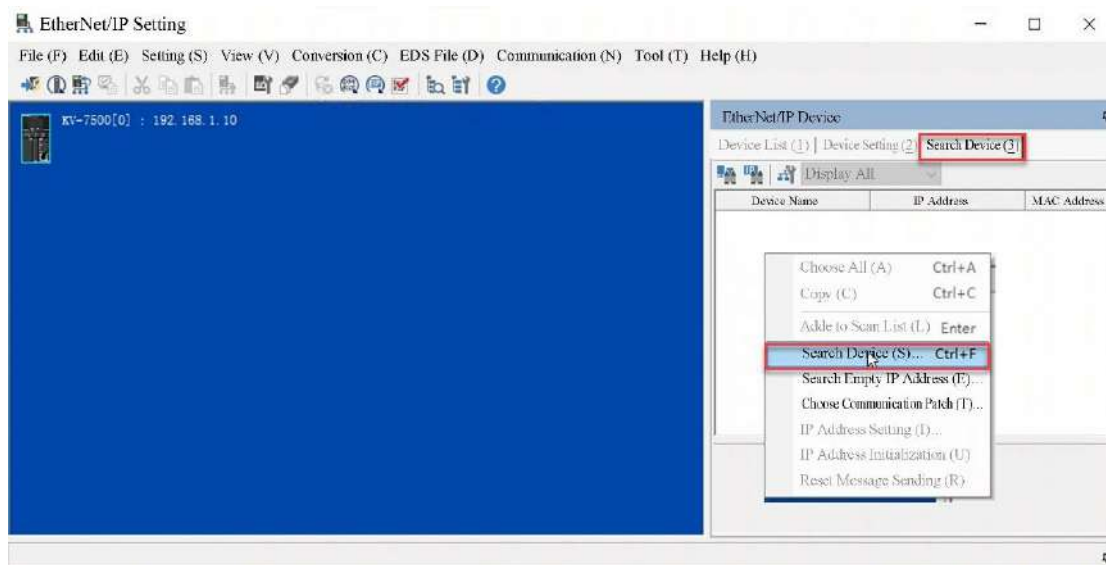

Figure 5-8-51 Device search

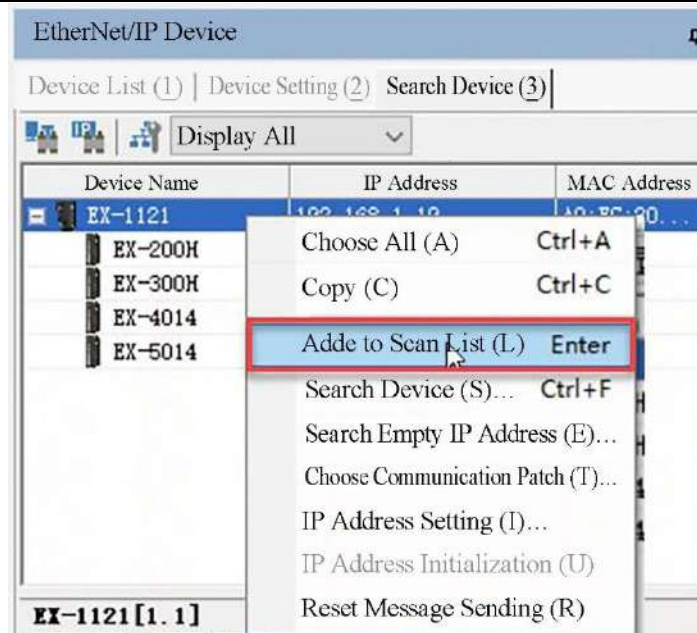

Figure 5-8-52 Adding devices to the scan list

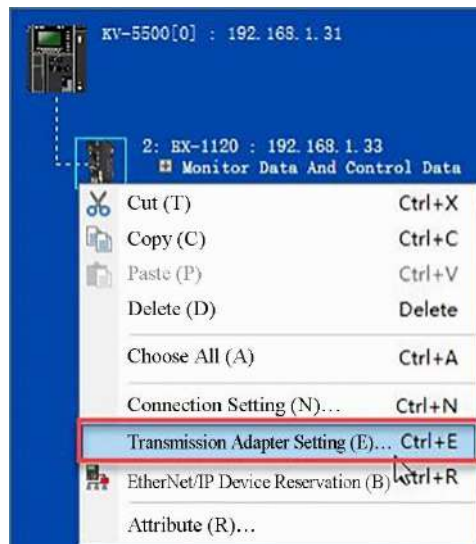

Figure 5-8-53 Adapter transfer Settings

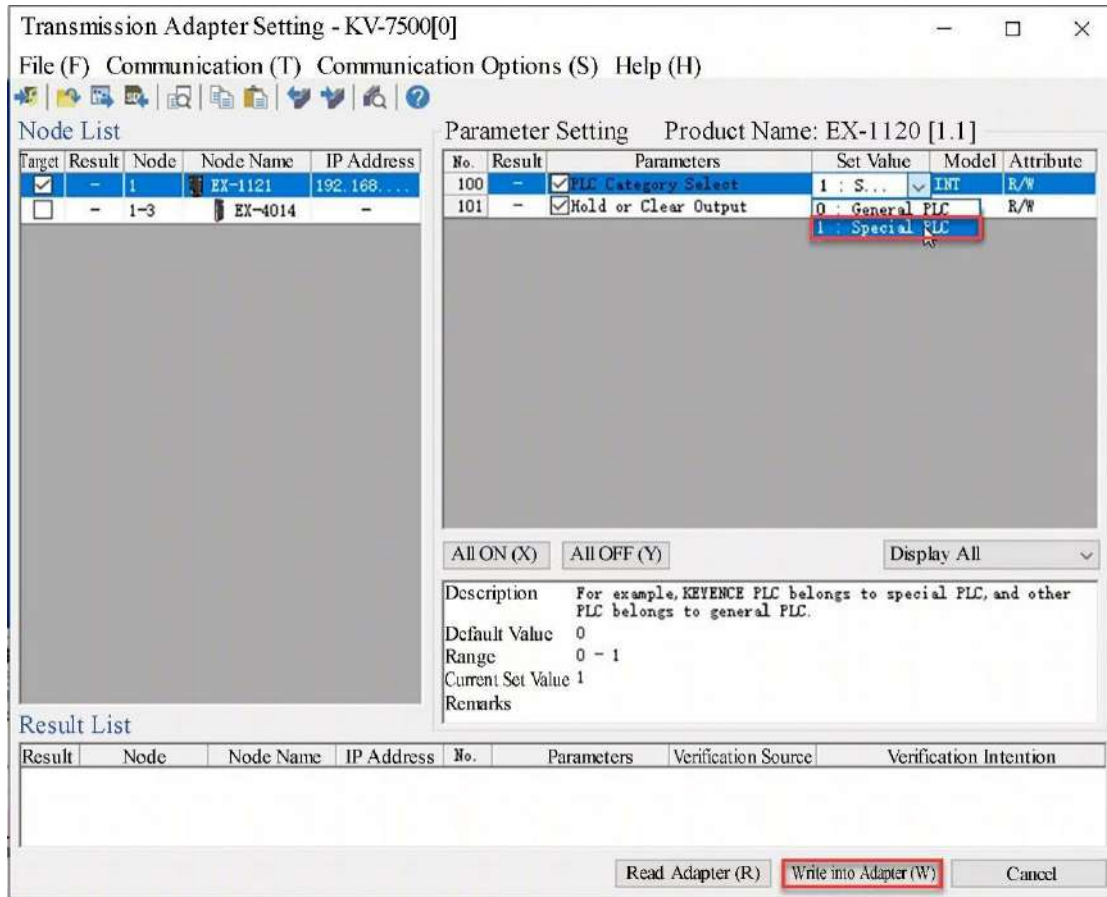

Figure 5-8-54 Write adapter

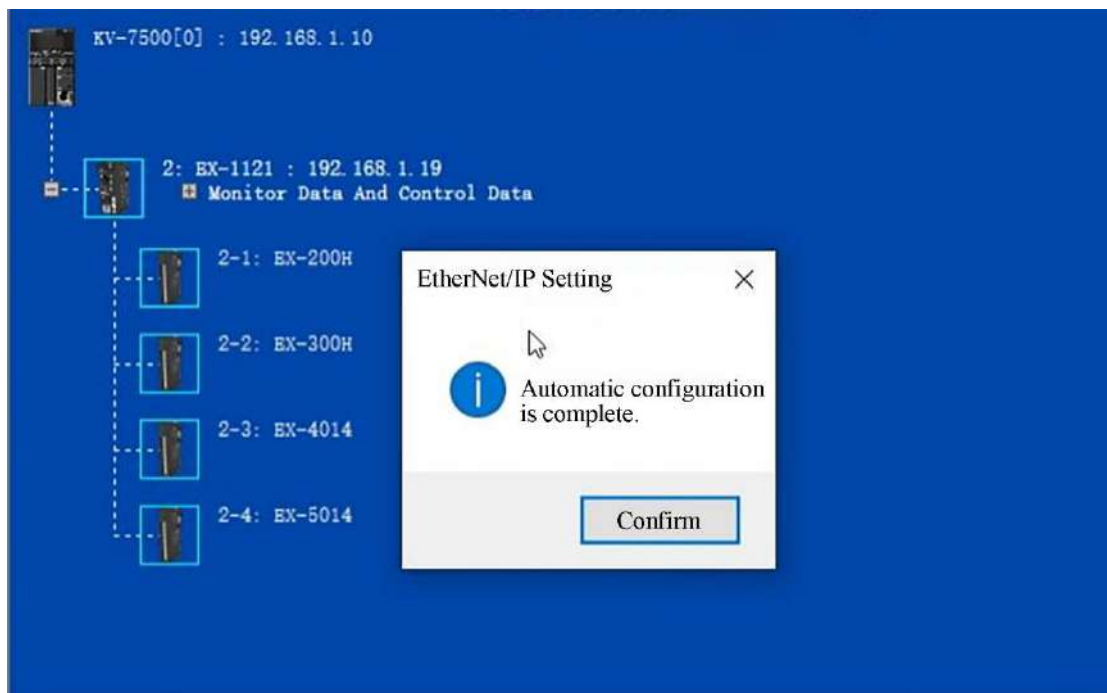

Figure 5-8-55 Re-reading ex-1121

Download the program into PLC and choose "Monitoring/Simulator" > "PLC Transmission" from the menu bar. After downloading, switch PLC to monitoring mode to monitor the communication status between PLC and EX-1121, as shown in Figure 5-8-56.

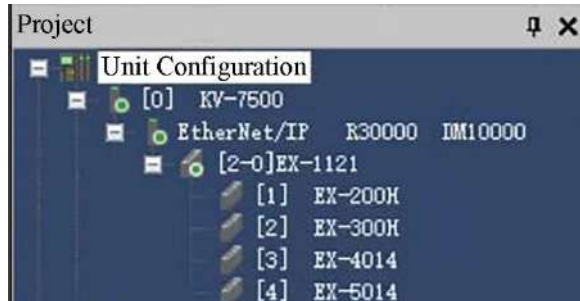

Figure 5-8-56 Monitoring the communication between PLC and EX-1121

5.9 Connection between Ex-1112 and PLC

5.9.1 Connection and Configuration between TIA Portal and EX-1112

1. Communication connection diagram, as shown in Figure 5-9-1.

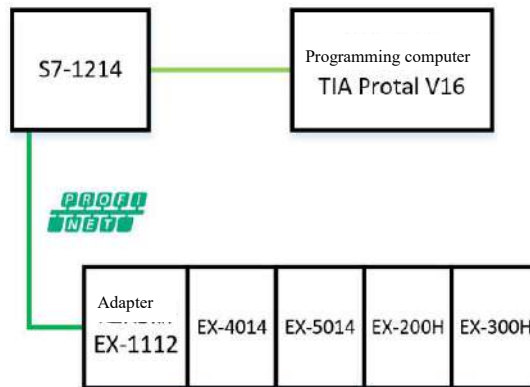

Figure 5-9-1 Communication connection diagram

2. Table 5-9-1 shows the hardware configuration

Table 5-9-1 Hardware configuration table

hardware	Quantity	note
Computer programming	1	Install TIA Portal V16
The controller	1	S7-1214C
EX-1112	1	PROFINET adapter
EX-4014	1	Analog input module

EX-5014	1	Analog output module
EX-200H	1	Digital quantity input module
EX-300H	1	Digital output module
Ethernet cable	A number of	

3. Install the GSD file

Open TIA Portal V16 and choose Options > Support Device Description File (GSD) from the menu bar, as shown in Figure 5-9-2.

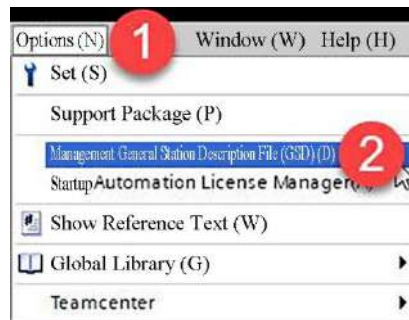

Figure 5-9-2 Installing GSD files

4. New project and equipment configuration

Open TIA Portal V16, select a new project and configure it, as shown in Figure 5-9-3.

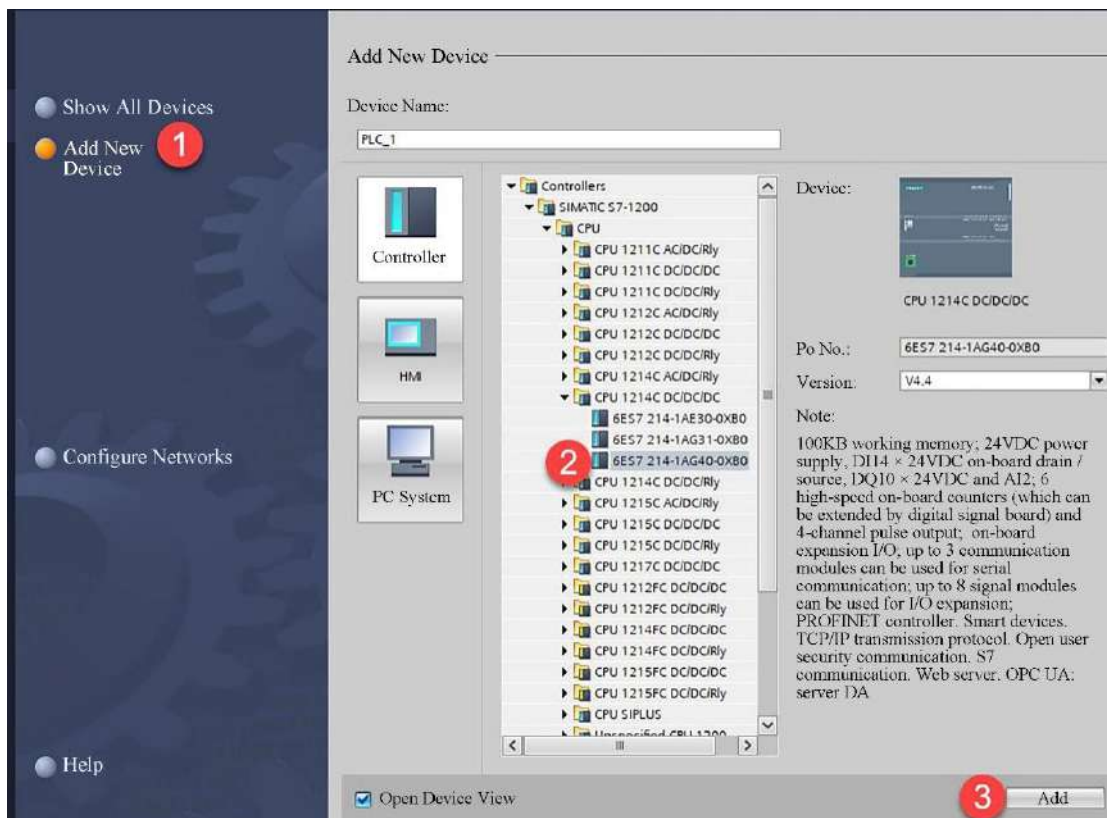



Figure 5-9-6 Assigning IO controllers

Set the IP address of the I/O module. In the device view, double-click the module to go to the properties view, as shown in Figure 5-9-7.

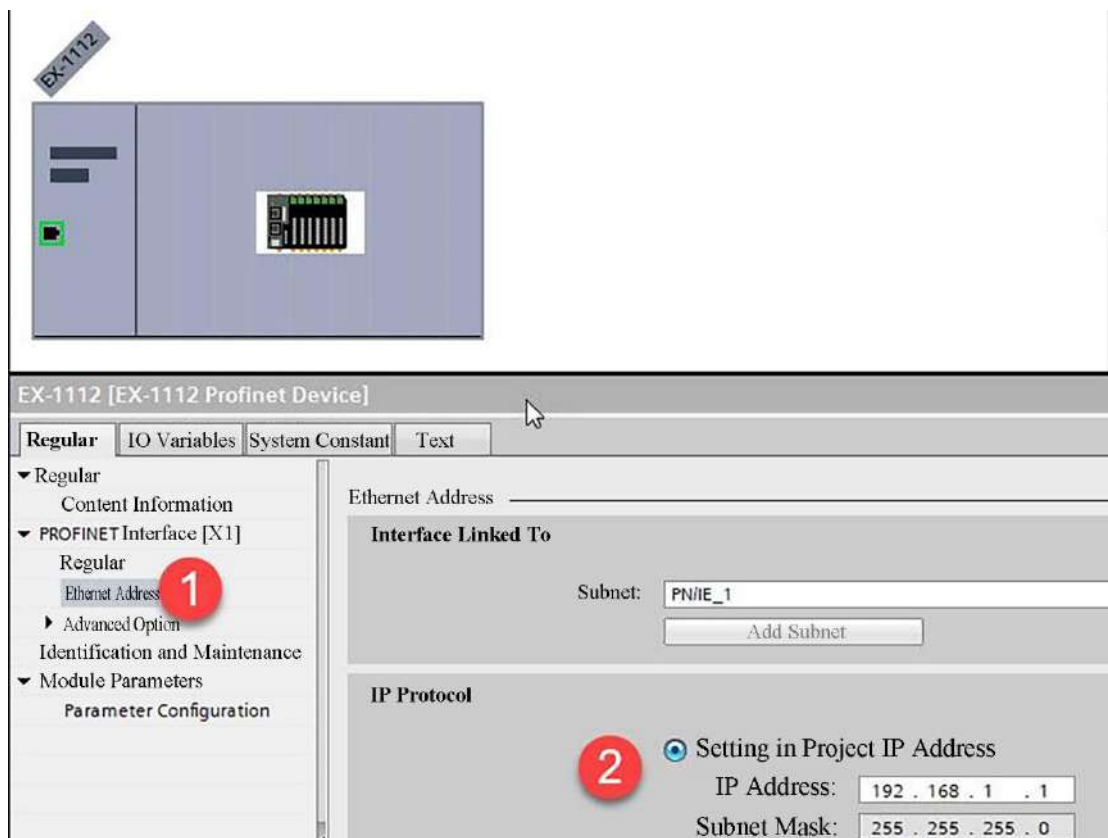

Figure 5-9-7 Assigning IP addresses

To assign a device name to a remote I/O module, right-click the module and choose Assign Device Name, as shown in Figure 5-9-8. Select the interface type, update the interface list, and assign the device name, as shown in Figure 5-9-9.

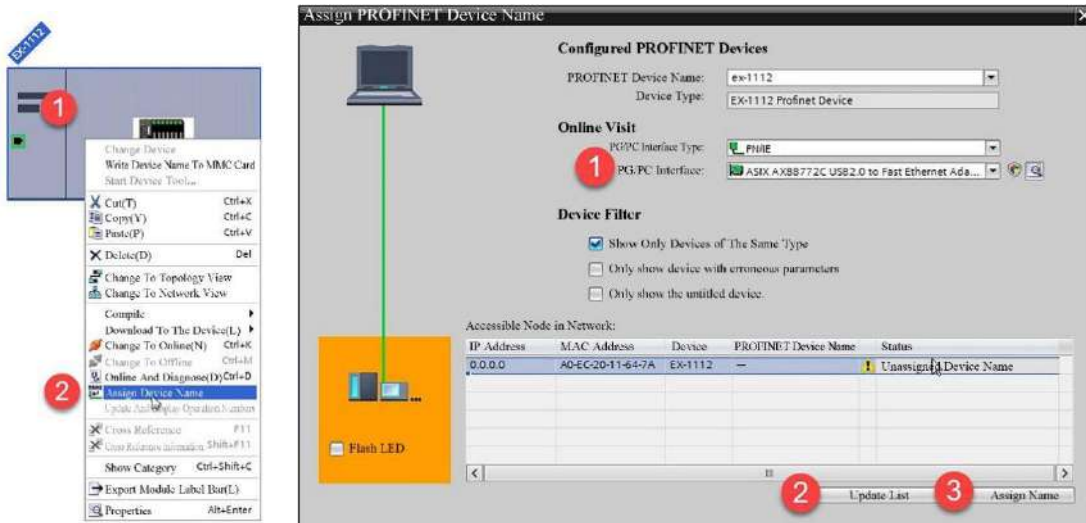

Figure 5-9-8 Assigning device names Figure 5-9-9 Writing device names

Modify the input channel filtering parameters of ex-2XXX series modules. In the overview view of the device view, right-click the input module and set the input channel filtering time (the default value is 3ms, and the range can be 0.5-10ms), as shown in Figure 5-9-10.

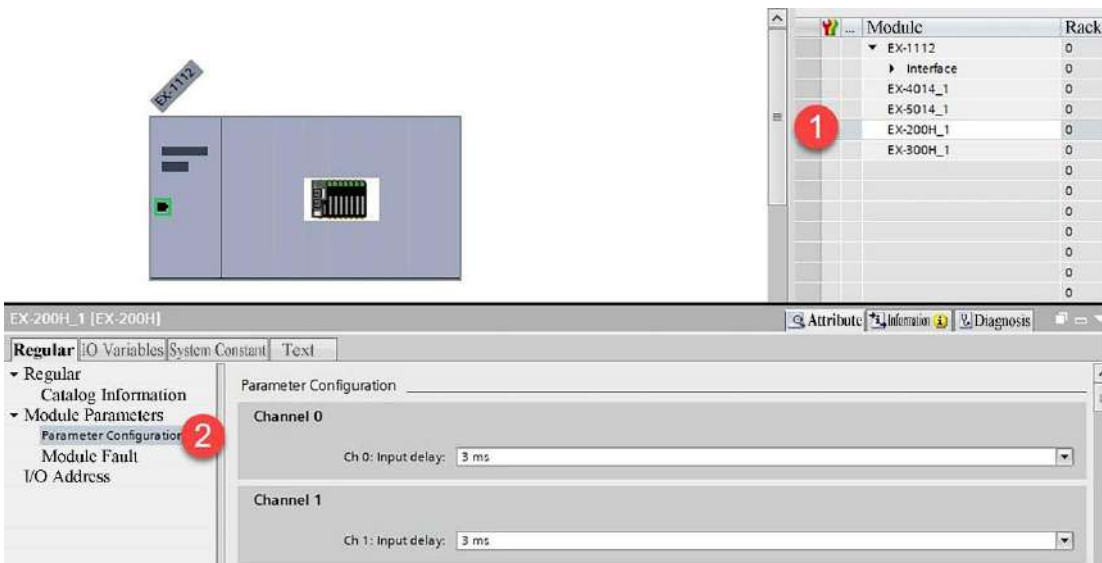

Figure 5-9-10 Configuring filtering parameters of the input module

5. Program download and equipment monitoring

Select all devices in the network view and download, as shown in Figure 5-9-11. After downloading the program, start the CPU and switch to online monitoring for normal communication, as shown in Figure 5-9-12.

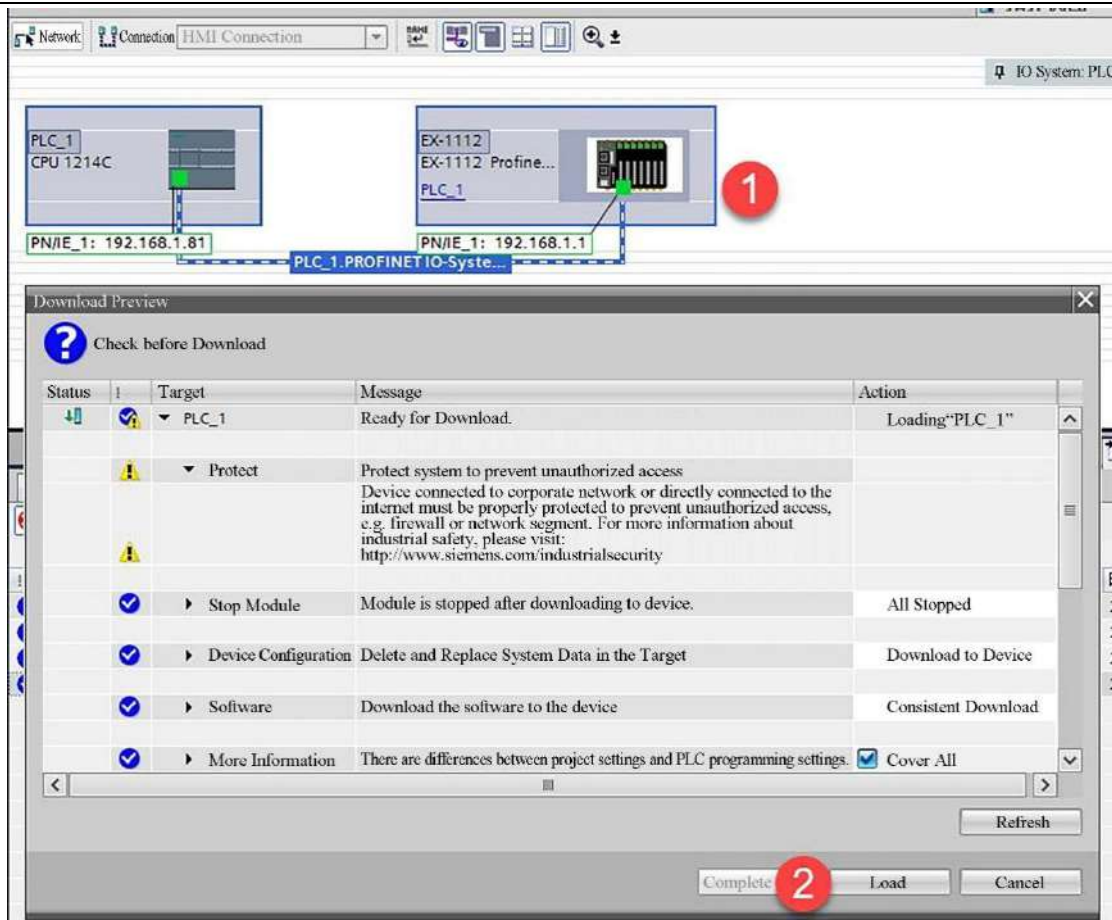

Figure 5-9-11 Program download

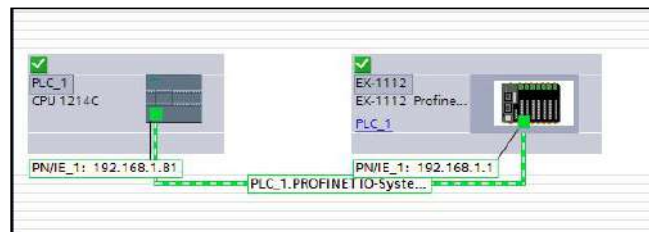

Figure 5-9-12 Equipment monitoring

5.9.2 Connection and Configuration between Step7 smart devices and EX-1112

1. Communication connection diagram, as shown in Figure 5-9-13.

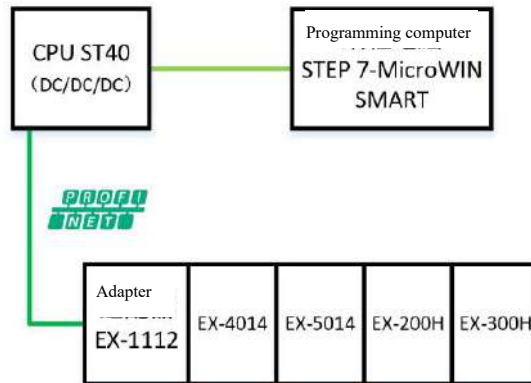

Figure 5-9-13 Communication connection diagram

2. Table 5-9-2 shows the hardware configuration

Table 5-9-2 Hardware configuration table

hardware	Quantity	note
Computer programming	1	Install STEP7 - MicroWIN SMART
The controller	1	CPU ST40(DC/DC/DC)
EX-1112	1	PROFINET adapter
EX-4014	1	Analog input module
EX-5014	1	Analog output module
EX-200H	1	Digital quantity input module
EX-300H	1	Digital output module
Ethernet cable	A number of	

3. Install the GSD file

Open Step 7-Microwin SMART, and choose GSDML Management from the menu bar, as shown in Figure 5-9-14.

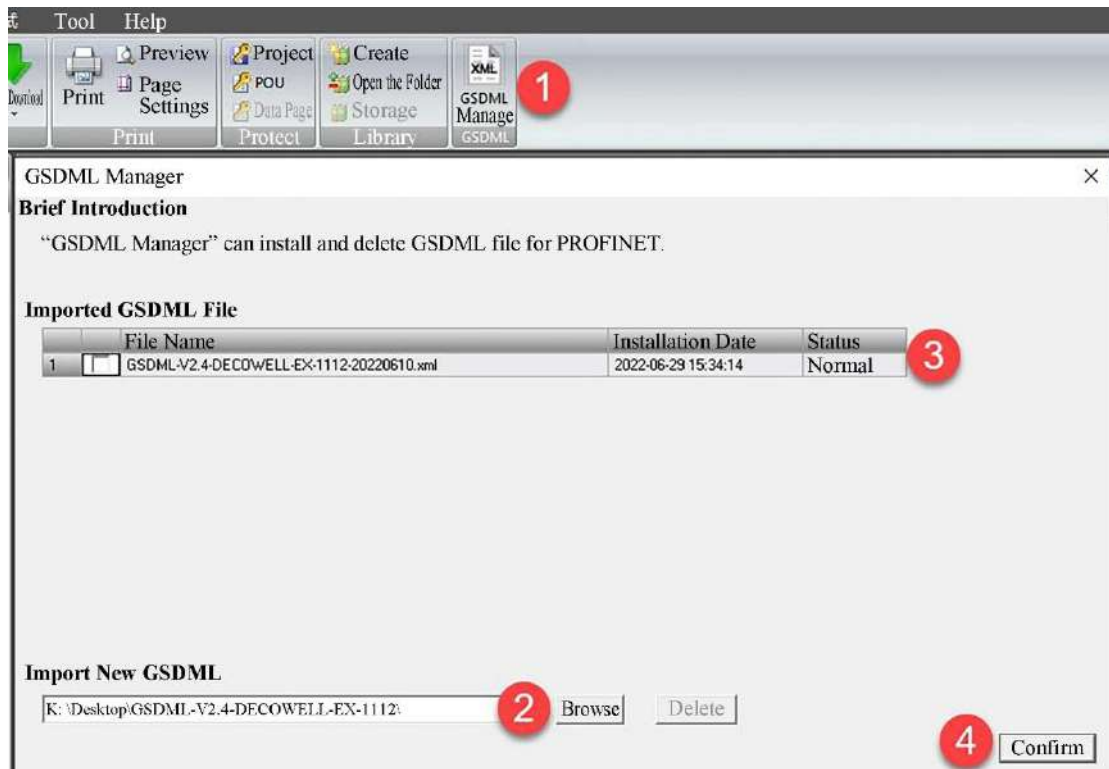

Figure 5-9-14 Installing GSD files

4. Assign the device name

On the menu bar, choose Tools > Find PROFINET Device, select the network adapter connected to the module in the window and find the device, select the module in the network and edit its device name, as shown in Figure 5-9-15.

Note:

① When you select a NIC, two options are displayed for the same NIC, as shown in the following figure. Select the NIC without Auto.

```
Realtek PCIe GBE Family Controller.TCPIP.1
Realtek PCIe GBE Family Controller.TCPIP.Auto.1
```

(2) After the device name is assigned, note that the device name must be the same as the assigned name when configuring the IO module; otherwise, PLC cannot communicate with the IO module normally.

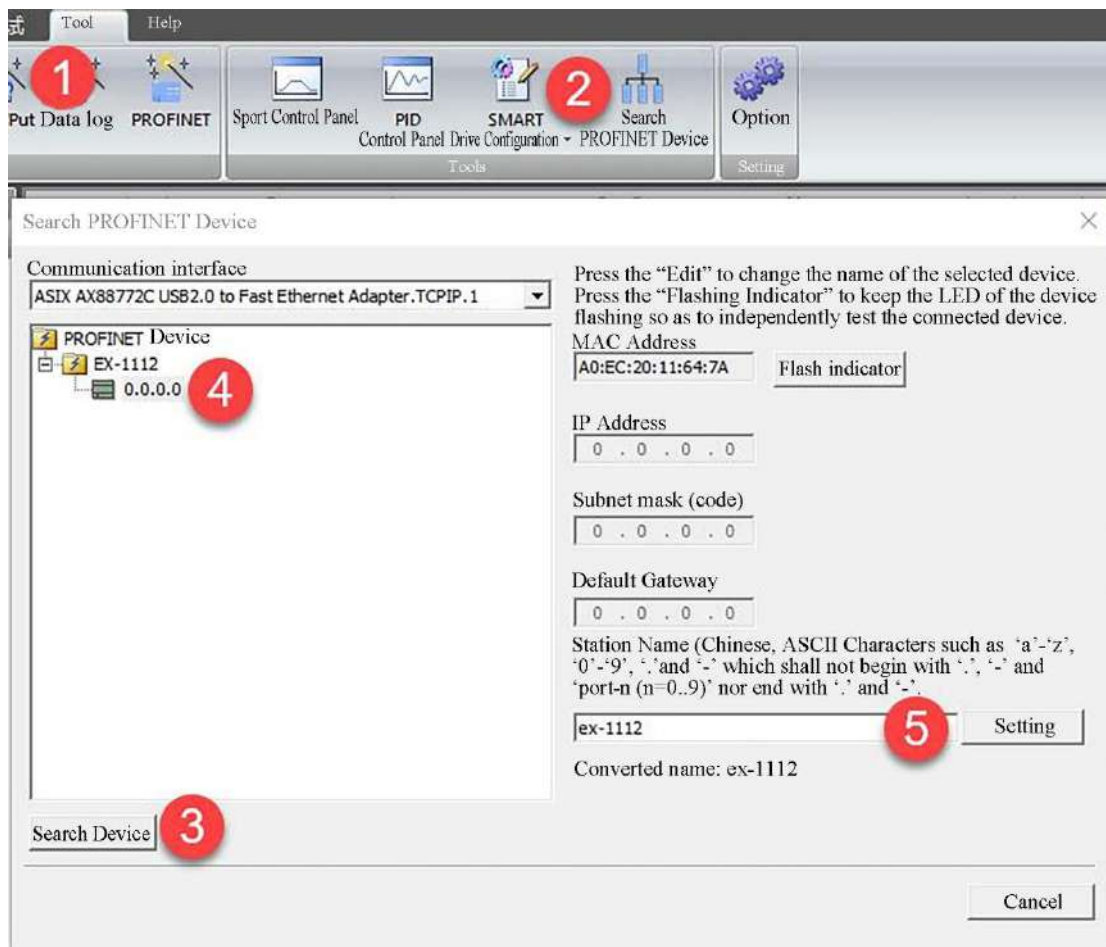

Figure 5-9-15 Assigning device names

5. New project and equipment configuration

On the menu bar, choose Tools > PROFINET, select the PLC role as the controller, as shown in Figure 5-9-16, add the adapter, assign the device name (the same as that assigned in Step 4) and IP address, as shown in Figure 5-9-17, add the IO module, as shown in Figure 5-9-18, and select Generate.

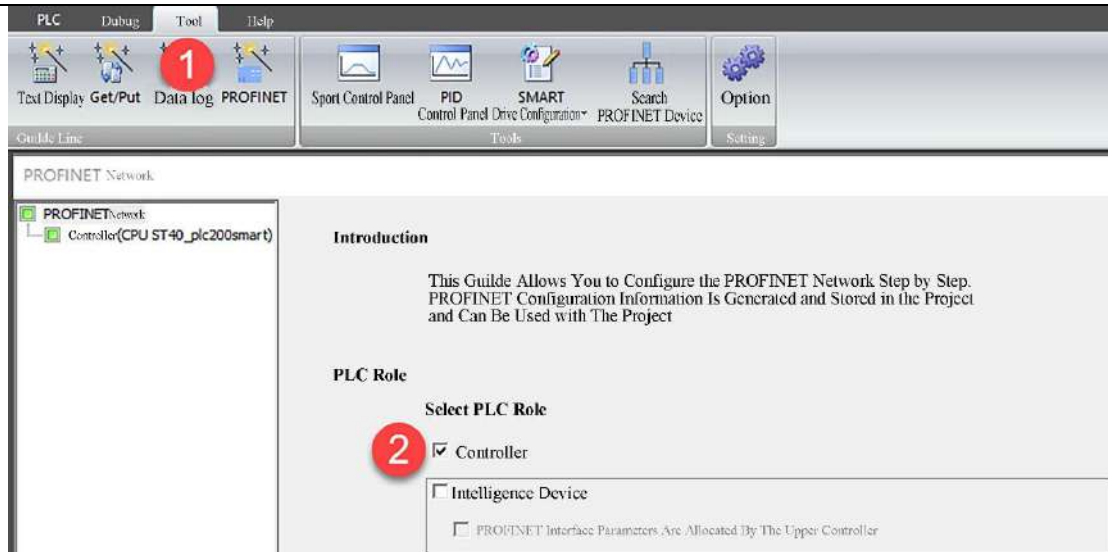

Figure 5-9-16 Selecting PLC roles

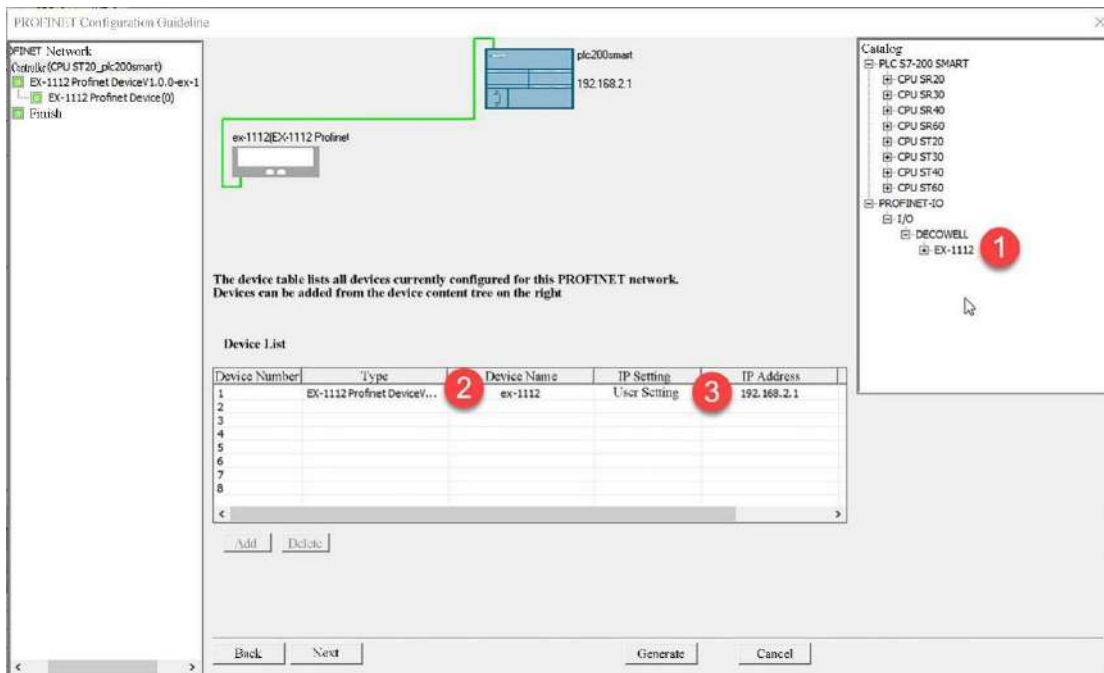

Figure 5-9-17 Adding an adapter

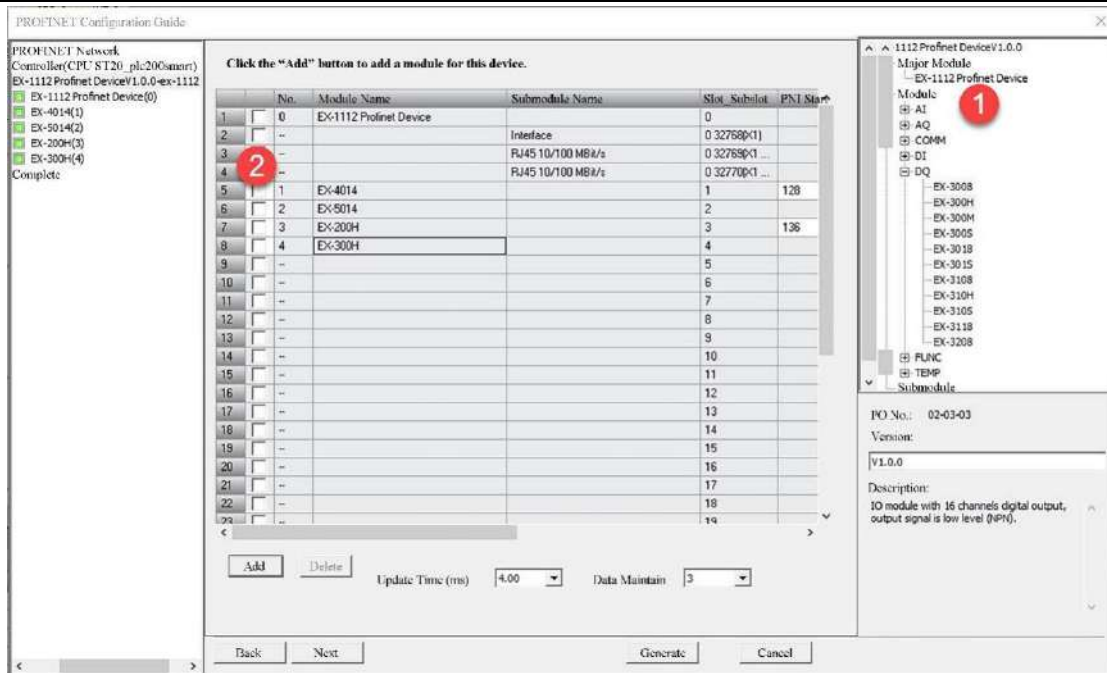

Figure 5-9-18 Adding an I/O module

Modify the filtering parameters of the input channel of ex-2XXX series modules. In PROFINET network, select the DI module to view its filtering time (the default is 3ms, and the range can be set to 0.5-10ms), as shown in Figure 5-9-19.

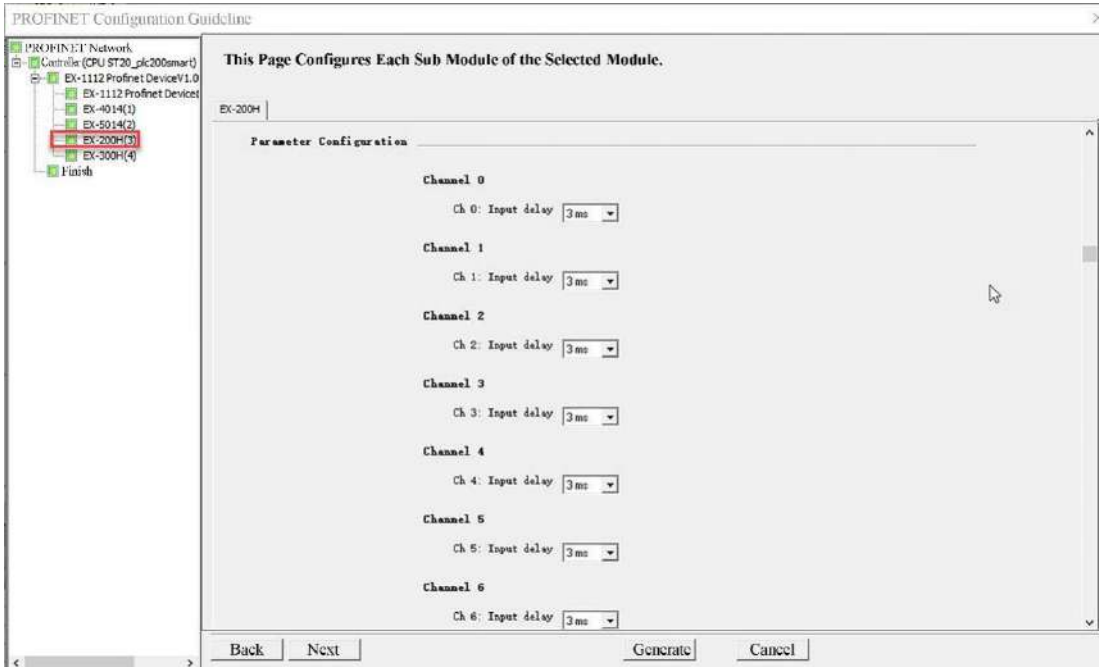

Figure 5-9-19 Configuring input module filtering parameters

6. Program download

Choose "PLC" > "Download" in the menu bar, and select "Find CPU" in the communication window, select the PLC that needs to download the program, and download the program.

Note: For PROFINET communication using STEP 7-Microwin SMART configuration 200 SMART, the CPU firmware version of PLC must be \geq V2.4. For firmware = V2.3, you can directly upgrade the firmware online. For firmware $<$ 2.3, you must update the firmware with a memory card in the CPU.

5.9.3 Connection and Configuration between Step7 and Ex-1112

1. Communication connection diagram, as shown in Figure 5-9-20.

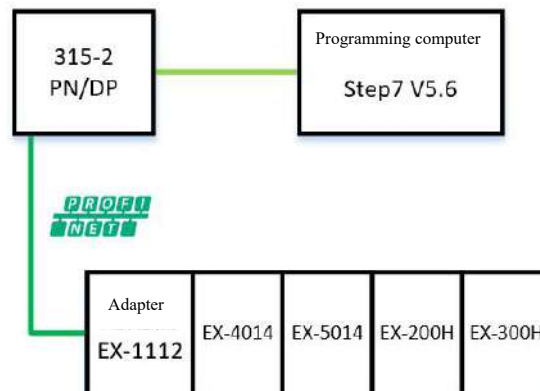

Figure 5-9-20 Communication connection diagram

2. Table 5-9-3 shows the hardware configuration

Table 5-9-3 Hardware configuration table

hardware	Quantity	note
Computer programming	1	Install Step7 V5.6
The controller	1	315-2 PN/DP
EX-1112	1	PROFINET adapter
EX-4014	1	Analog input module
EX-5014	1	Analog output module
EX-200H	1	Digital quantity input module
EX-300H	1	Digital output module
Ethernet cable	A number of	

3. Install the GSD file

After the new project is created, click "SIMATIC300", double-click "Hardware", in the HW Config window, choose "Options" > "Install GSD file" from the menu bar, as shown in Figure 5-9-21.

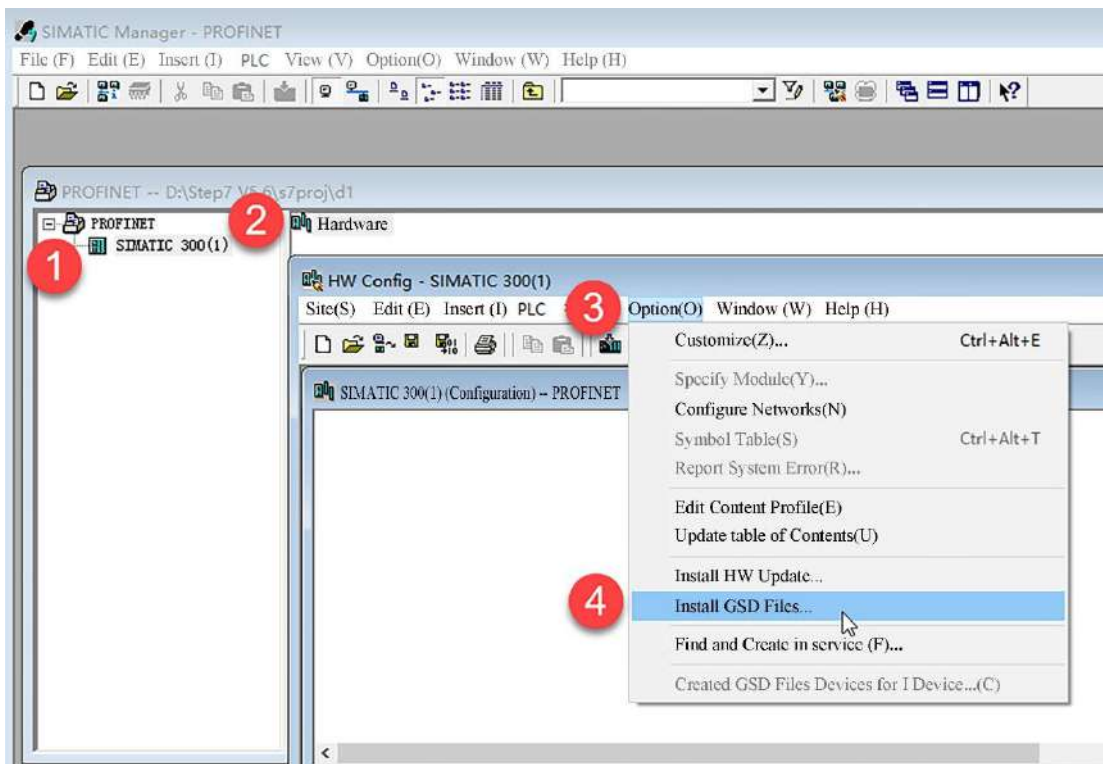

Figure 5-9-21 Installing GSD files

3. New project and equipment configuration

Open SIMATIC Manager, choose New Project from the menu bar, name the project, and select a path to save the project, as shown in Figure 5-9-22.

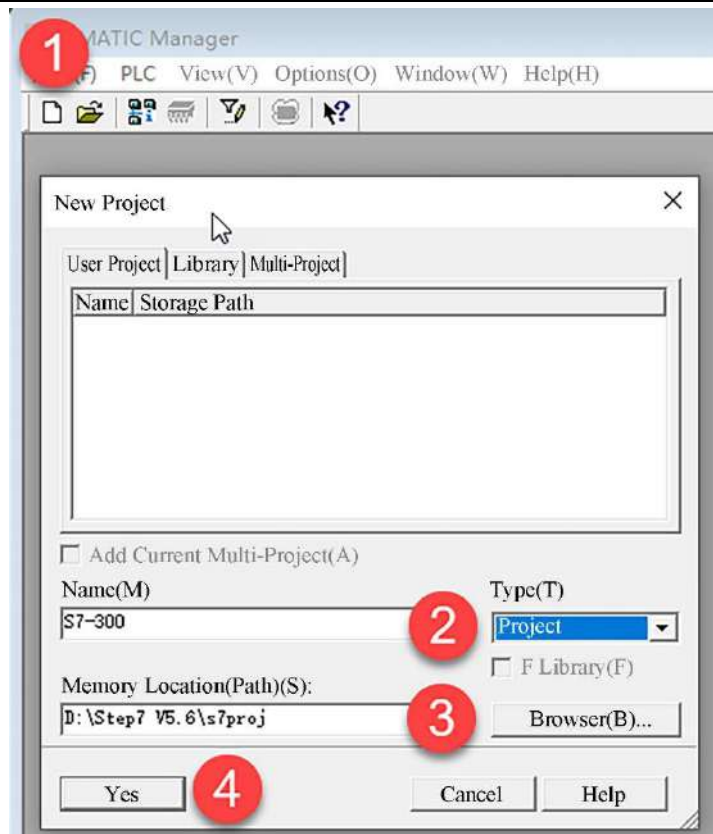

Figure 5-9-22 New construction project

Add 300 sites in the project, as shown in Figure 5-8-23. Click the newly added 300 site and select "Hardware" to enter the HW Config configuration interface, as shown in Figure 5-9-24. Add RACK Reil for RACK 300, as shown in Figure 5-9-25. To add a CPU module, click HW Config, select CPU315-2 PN/DP VERSION V2.6 of CPU-300 in the right pane, and drag the CPU module to slot 2 of the rack, as shown in Figure 5-9-26. In the Ethernet interface properties interface, you can use other IP addresses as required, here use the default IP address and subnet mask, and select the New button, create a new subnet Ethernet (1) click OK, as shown in Figure 5-9-27.

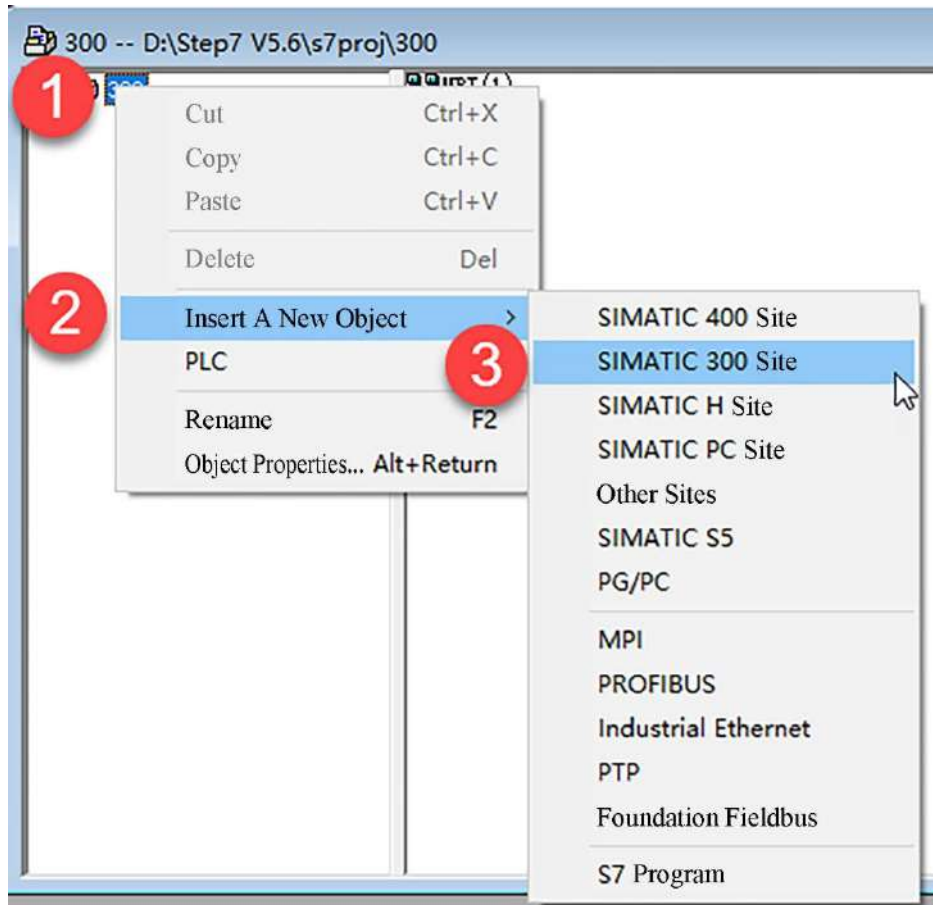

Figure 5-9-23 Adding 300 sites

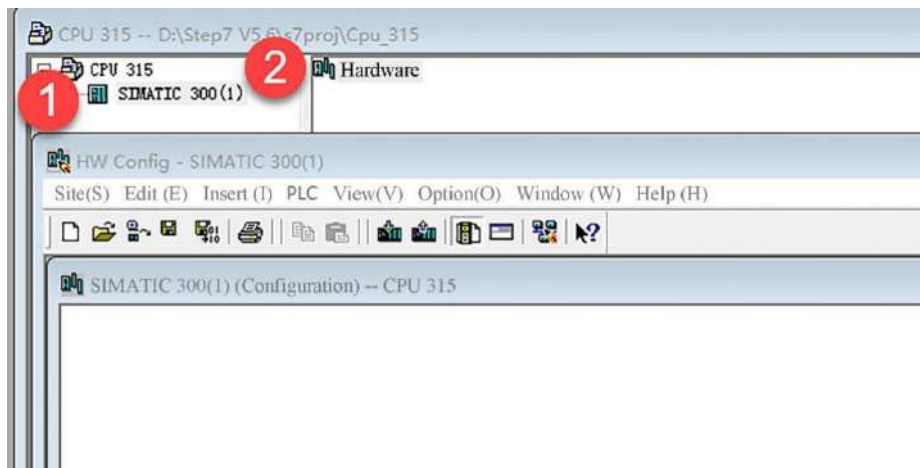

Figure 5-9-24 The HW Config page is displayed

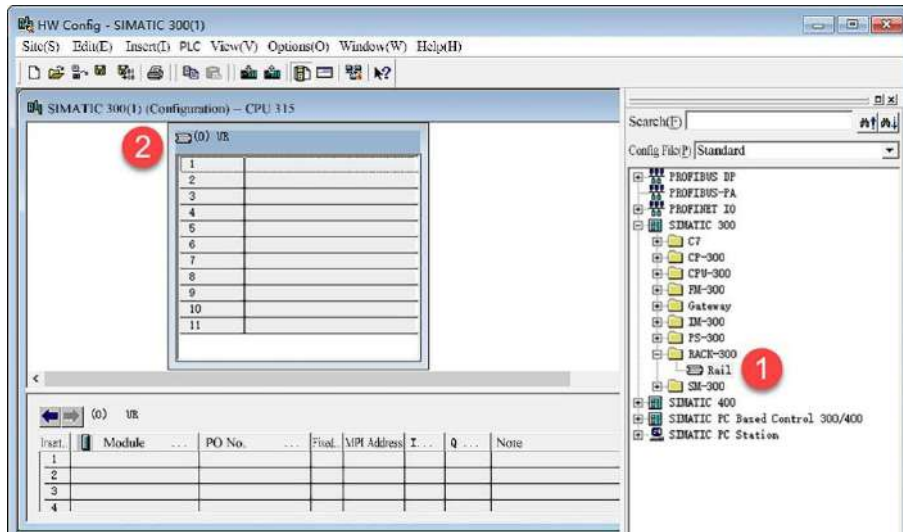

Figure 5-9-25 Adding rack Reil

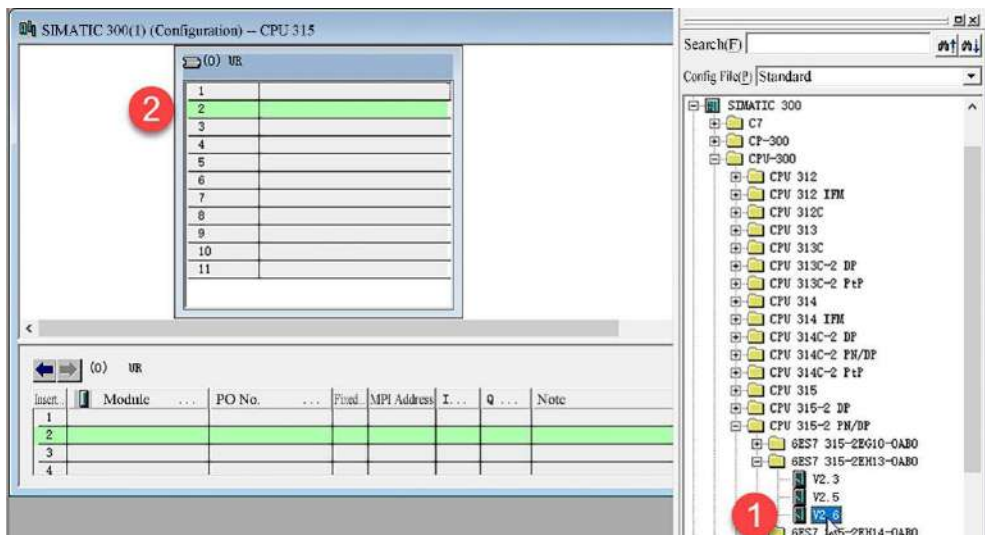

Figure 5-9-26 Adding a CPU module to the rack

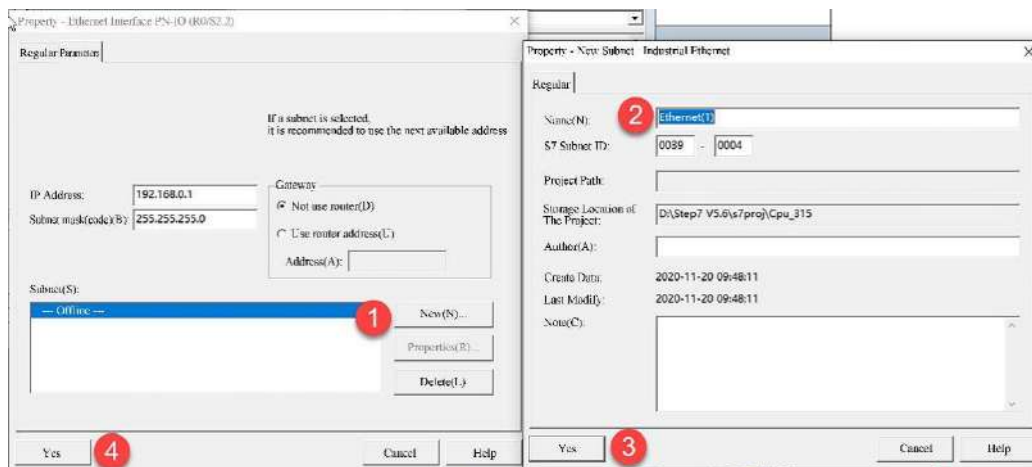

Figure 5-9-27 Adding an Ethernet subnet

On Ethernet (1), configure the I/O device station. On the right, select EX-1112 and drag it under the Ethernet (1) subnet, as shown in Figure 5-9-28.

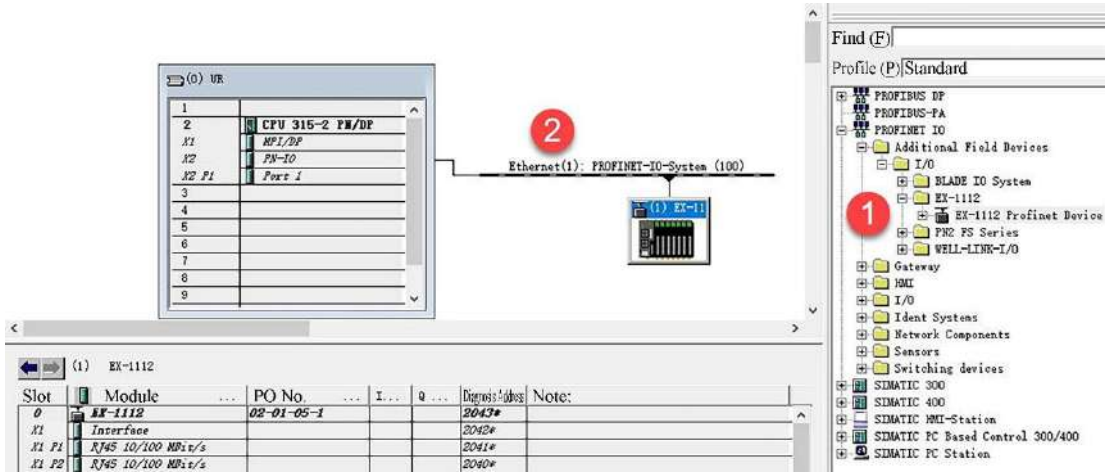

Figure 5-9-28 Adding IO to an Ethernet (1) subnet

Add an I/O module, expand the ex-1110 on the right, and drag the EX-4014 and EX-5014 to the lower slot on the left, as shown in Figure 5-9-29.

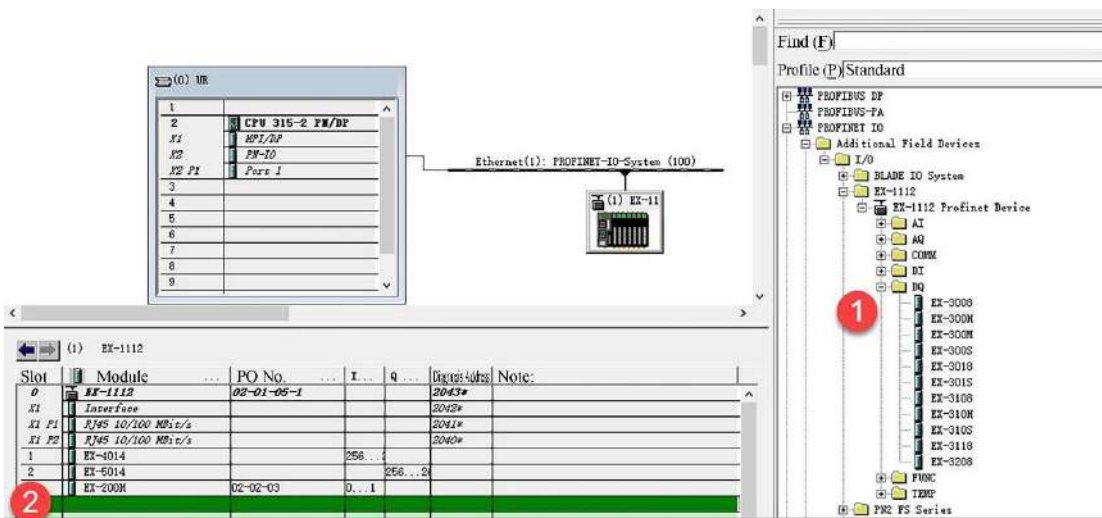

Figure 5-9-29 Adding an I/O module

To change the IP address of the I/O device station, double-click ex-1112 on the subnet, and choose Ethernet in the Ethernet property window. You can change the IP address in the Ethernet property window, as shown in Figure 5-9-30.

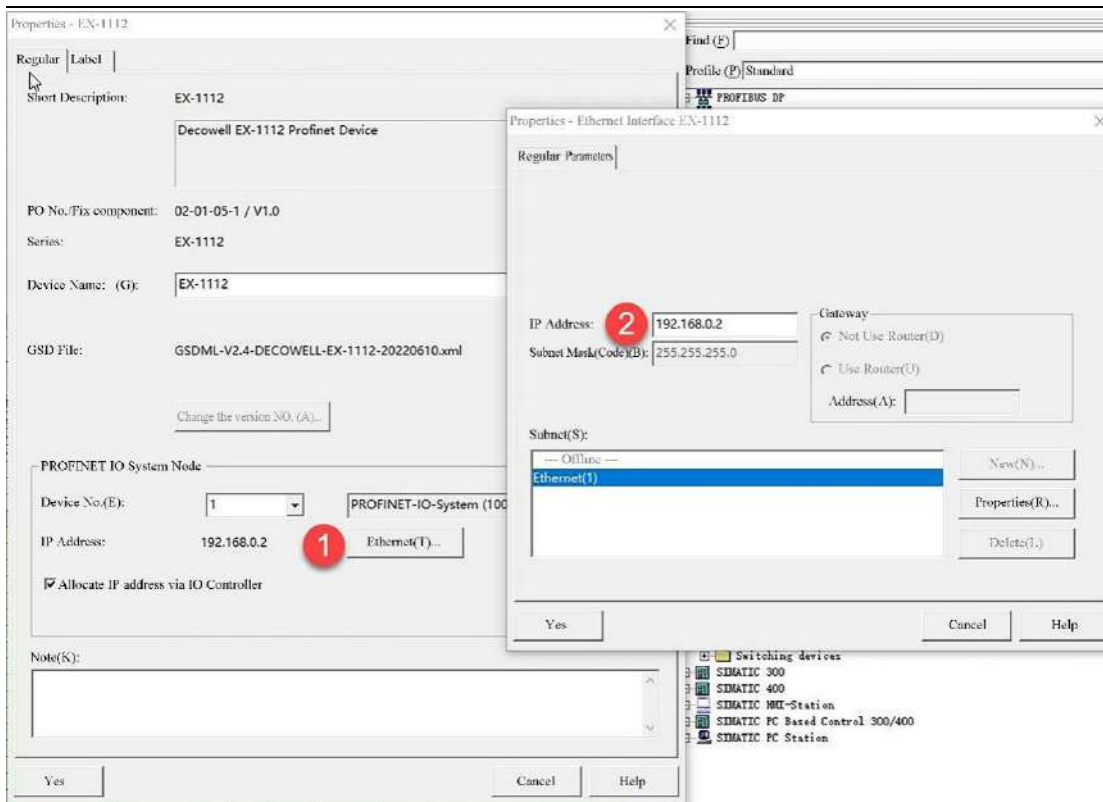

Figure 5-9-30 Changing the MODULE IP address

Set the device name for the I/O module, select the subnet icon, choose PLC on the menu bar, Ethernet > Assign Device Name, as shown in Figure 5-9-31. In the Assign Device name window, select the name to be assigned, and press Ok.

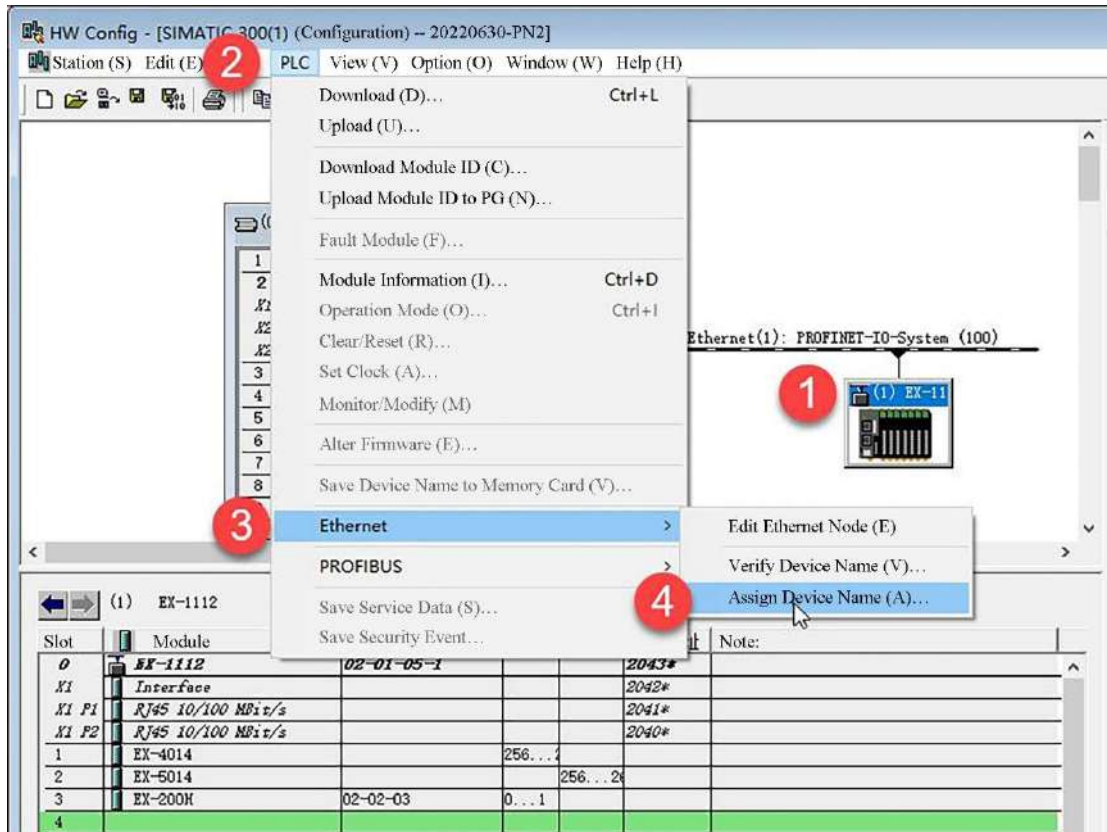

Figure 5-9-31 Assigning device names

To check whether the name is assigned successfully, select the subnet icon, choose PLC on the menu bar, and Ethernet > Verify Device Name, as shown in Figure 5-9-32.

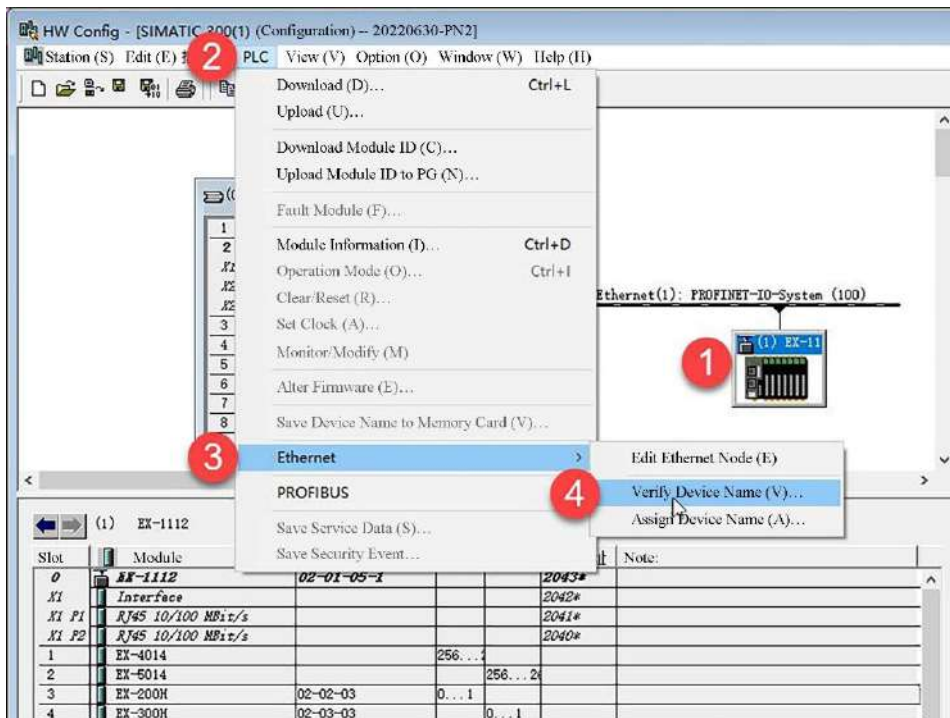

Figure 5-9-32 Verifying the device name

Modify the filtering parameters of the input channel of the ex-2xxx series modules. In the ex-1112 slot, double-click the DI module to view the filtering time (3ms by default, and the range can be 0.5-10ms), as shown in figure 5-9-33.

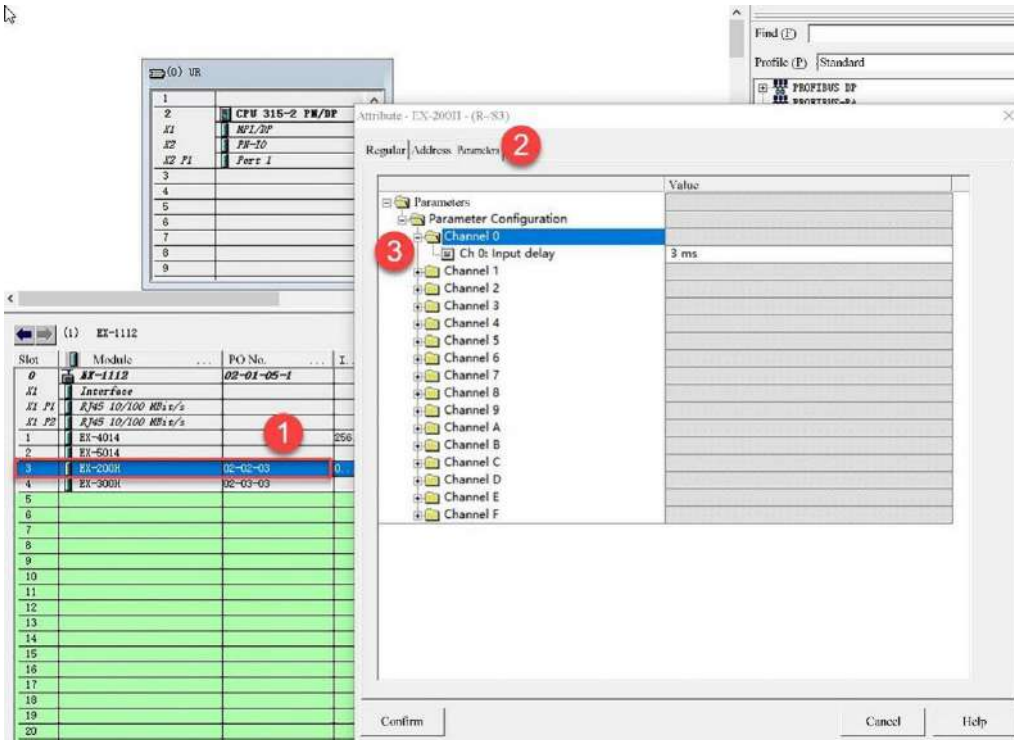

Figure 5-9-33 Configuring input module filtering parameters

6 Module Application

6.1 Module Configuration

6.1.1 How many I/O modules can an adapter support

The number of modules an adapter can support depends on the device master protocol (for example, CC-Link), the maximum number of I/O extensions of the adapter (the maximum number of I/O extensions of the adapter is 32 IO), the number of input and output bytes of the adapter (for example, PROFINET input and output bytes are 340 bytes, EtherCAT input and output bytes are 1024 bytes), Table 6-1 lists the maximum input/output bytes of an adapter. Table 6-2 lists the maximum input/output bytes of an I/O module

Table 6-1 Maximum number of input and output bytes of an adapter

The adapter	Maximum	Maximum number of input	Maximum number of

	I/O quantity	bytes	output bytes
EtherCAT	32	1024	1024
PROFINET	32	340	340
DeviceNet	32	-	-
CC-Link	32	128	128
CANopen	32	512	512
PROFIBUS-DP	32	244	244
Modbus RTU	32	512	512
EtherNet/IP	32	504	504

Table 6-2 I/O module input/output bytes

Module type	Number of input bytes	Output bytes
8DI	1	-
16DI	2	-
32DI	4	-
4AI	8	-
8AI	16	-
8DO	-	1
16DO	-	2
32DO	-	4
4AO	-	8
8DO	-	16
TC	8	-
RTD	8	-
The encoder	9	5
Positioning module	5	18
RS232	66	66
RS485	66	66

- To calculate how many IO modules an adapter can carry, the following two equations must be met:

The NUMBER of I/O modules configured with the adapter is less than or equal to 32.

The number of INPUT and output bytes of the I/O module with the adapter is less than or equal to the number of input and output bytes specified by the adapter.

- For example, cc-link supports a maximum of 4 x (32DI+32DO+4AI+4AO) for a single adapter (128 bytes in input / 128 bytes in output).

Note:

- (1) The greater the sum of the input and output bytes of the I/O module, the longer the communication period between the adapter and the I/O module.
- (2) Terminal modules and power modules are not counted in the I/O module count.

6.1.2 Adapter Parameter Setting Problems

- EtherCAT adapter
Current versions of the EtherCAT coupler do not support setting the slave address via dip.
- PROFINET adapter
Assign IP addresses and names, such as TIA Portal and Step7, to the host computer.
- PROFIBUS DP adapter
The communication address is assigned by dip switch, and the baud rate is set by the host computer, such as TIA Portal and Step7.
- CC - Link adapters
Assigns address and baud rate by DIP switch.
- DeviceNet adapter
Assigns address and baud rate by DIP switch.
- CANopen adapter
Assigns address and baud rate by DIP switch.
- Modbus RTU adapter
Modify communication parameters (such as data bits and parity check) by software, and assign communication address and baud rate by DIP switch.

6.1.3 Maximum output current of the digital output module

- 8 do module
The maximum output of a single channel is 500mA. When eight channels are simultaneously output, the total output current of the eight channels is 2A.
- 16 do module
The maximum output of a single channel is 500mA. When 16 channels are simultaneously output, the total output current of the 16 channels is 4A.
- 32 do module
The maximum output of a single channel is 500mA. When 32 channels output at the same time, the total output current of 32 channels is 8A.

- 8 RELAY module

Single channel 2A, DC30V/0.5A, AC125V.

6.1.4 Differences between system Power Supplies and I/O Power supplies

- System power supply: provides power for the communication of the EXTENSION I/O module.
- I/O power supply: Supplies power to the output channels of the expansion I/O module, such as digital output and analog output.

6.1.5 Can the output module control the inductive load

- Yes, all transistor digital output modules have continuous diode protection.

6.1.6 DeviceNet Adapter Networking

- The communication terminal of the adapter must be connected to an independent DC24V power supply.
- You need to configure two terminal resistors, one is the two terminals of the network, the specification is $121\ \Omega$, 1/4W.

6.1.7 Whether the Thermal resistance/thermocouple module supports filtering configuration

- Yes. You can configure different filtering levels (0-40) by parameter. The default value is 10.

6.1.8 Analog input module 2-wire / 3-wire / 4-wire connection method

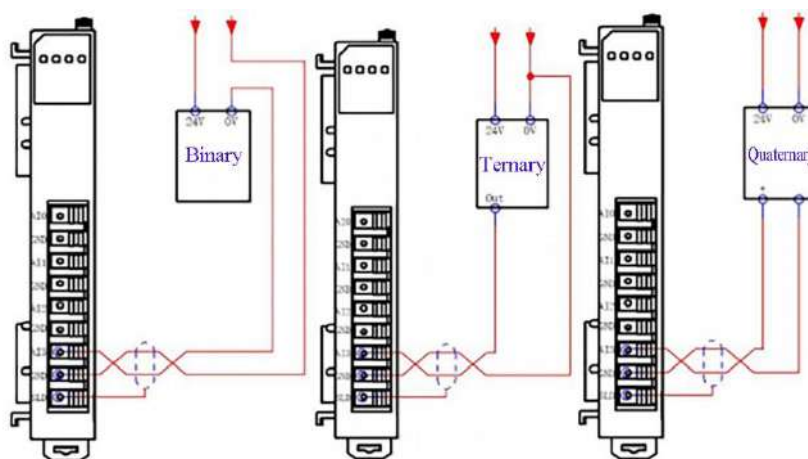

Figure 6-1-1 Analog input 2/3/4 line wiring

6.1.9 EX-1120/EX-1121 Output Hold Settings

- Schneider Machine Expert V2.0 software is configured with EX-1120 output IO hold, as shown in Figure 6-1-2. Clear indicates that the output is not held, and Hold indicates that the output is held.

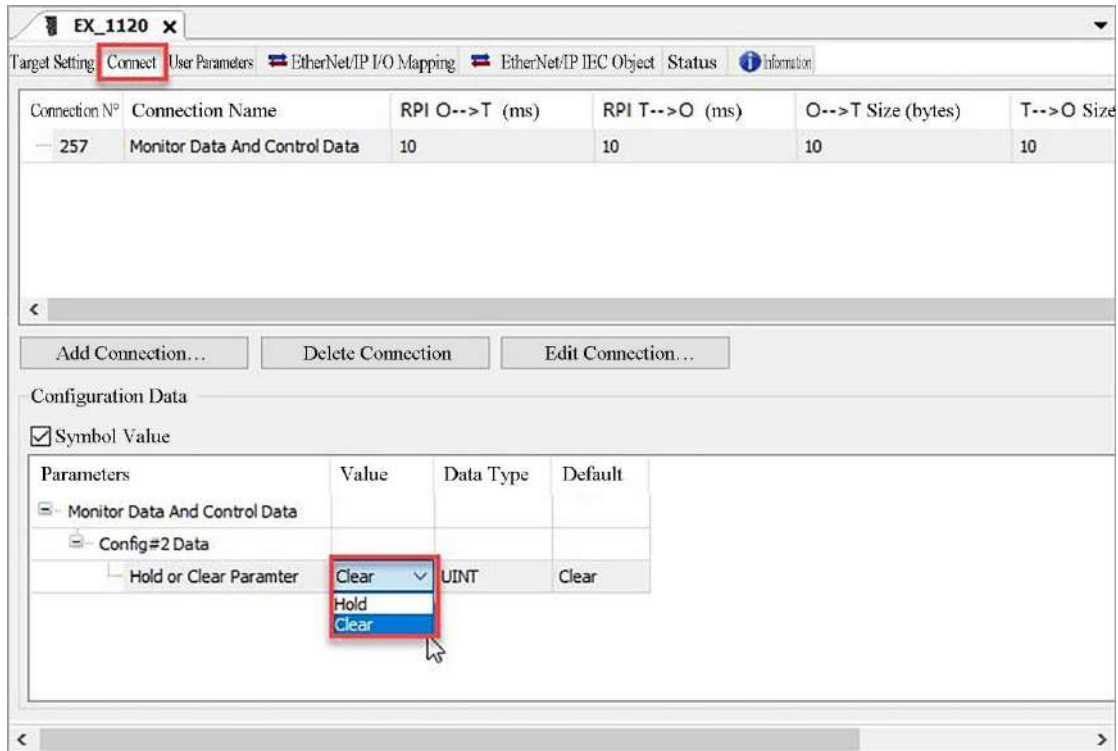

Figure 6-1-2 Schneider programming software configuration output hold

- EX-1120 output I/O hold is configured in CODESYS programming software, as shown in Figure 6-1-3.

Clear indicates that the output is not held, and Hold indicates that the output is held

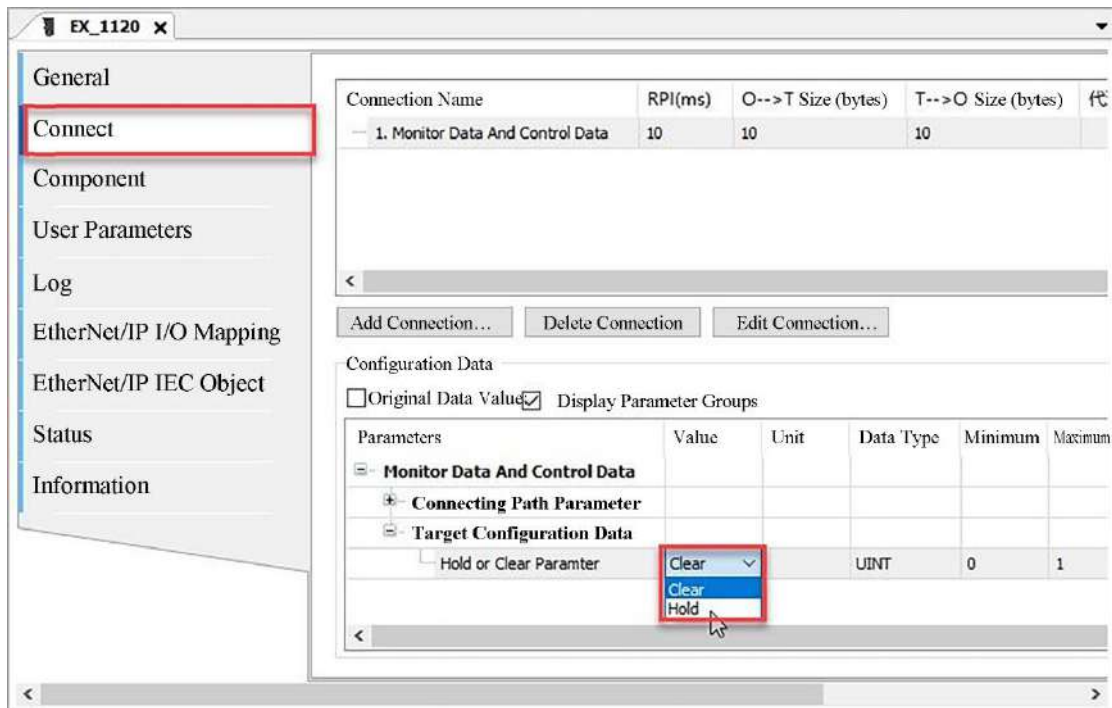

Figure 6-1-3 CODESYS programming software configuration output retention

- Ex-1120 output IO hold is configured by Omron Sysmac Studio programming software, as shown in Figure 6-1-4 and 6-1-5. **Clear** indicates that the output is not held, and **Hold** indicates that the output is held.

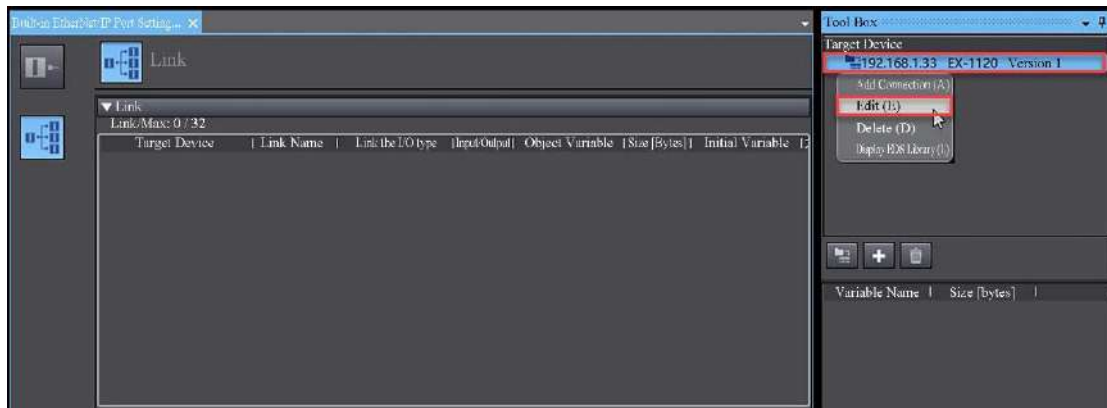

Figure 6-1-4 Editing ex-1120

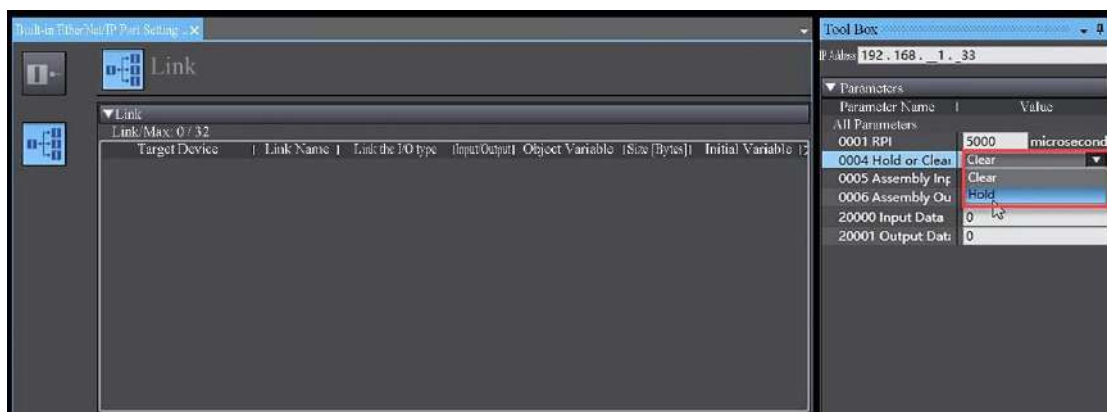
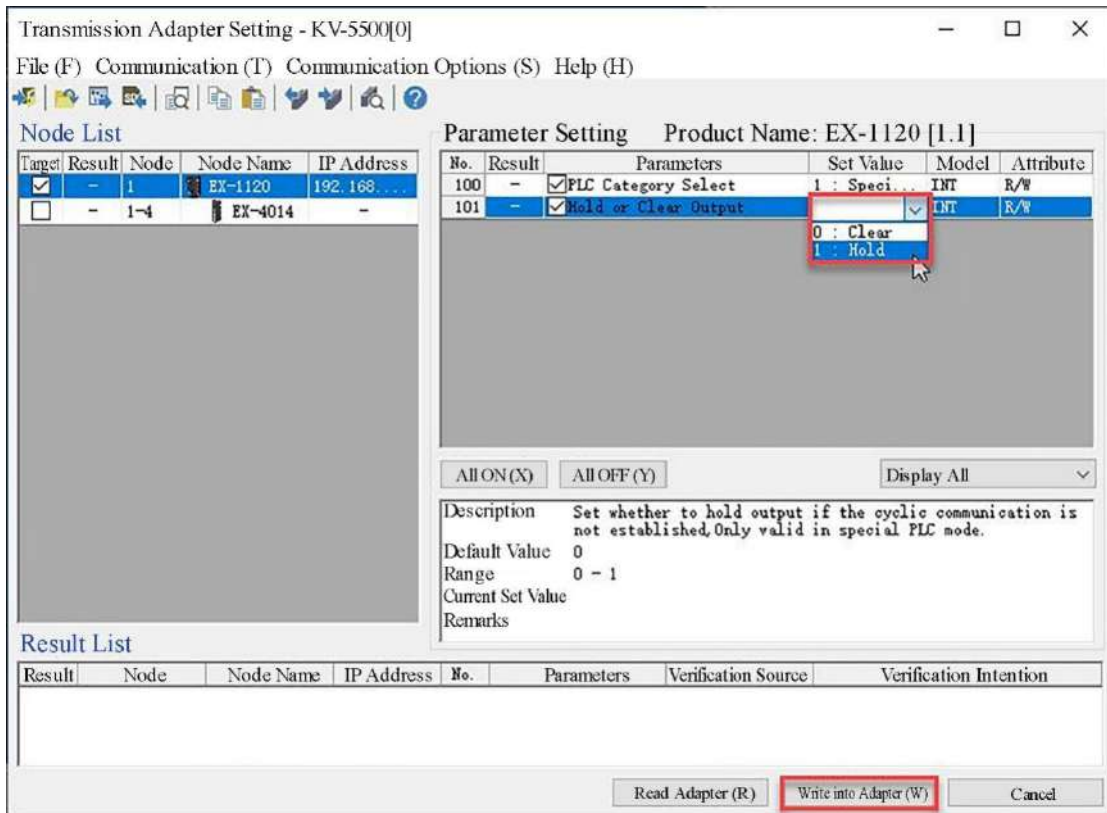

Figure 6-1-5 Omron Sysmac Studio programming software configuration output hold

- The PROGRAMMING software of KV STUDIO is configured with EX-1120 output IO retention, as shown in Figure 6-1-6. **Clear** indicates that the output is not held, and **Hold** indicates that the output is held.



KV STUDIO programming software configuration ex-1120 output hold

6.2 Common communication exceptions and exclusion methods

6.2.1 EtherCAT Communication is abnormal

- Figure 6-2-1 shows the troubleshooting process when the communication with Omron PLC is abnormal.

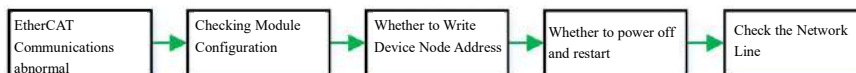

Figure 6-2-1 Troubleshooting process

- Ex-1100 adapter indicator

SYS indicator light	
System light status	instructions
Blinking at long intervals (1HZ)	The system runs normally.
destroy	The I/O module type does not match
1 shine 1 fade	Communication with the I/O module fails
2 Flash 1 Off	The I/O module fails to be configured
Blinking at short intervals (5HZ)	I/O module missing

6.2.2 PROFINET communication Is Abnormal

- Figure 6-2-2 shows the troubleshooting process when communication is abnormal.

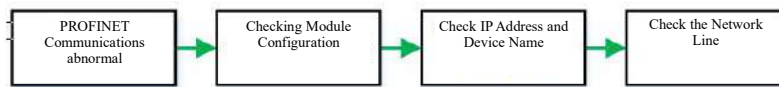

Figure 6-2-2 Troubleshooting process

- During module configuration, check whether the host configuration is consistent with the actual hardware configuration.
- When assigning IP addresses, ensure that the IP addresses do not overlap with those of other devices on the network.
- Before downloading the configuration, you must write the device name into the device. The device name is unique and cannot coincide with other device names on the network.

6.2.3 DeviceNet Communication Is Abnormal

- Figure 6-2-3 shows the troubleshooting process when communication is abnormal.

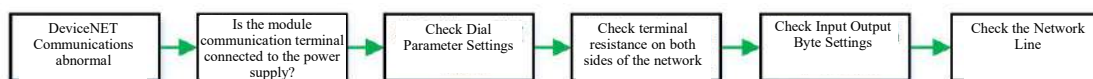

Figure 6-2-3 Troubleshooting process

6.2.4 CC-link Communication is abnormal

- Figure 6-2-4 shows the troubleshooting process when communication is abnormal.

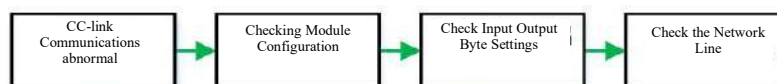

Figure 6-2-4 Troubleshooting process

6.2.5 Modbus RTU Communication Is Abnormal

- If the communication is abnormal, the troubleshooting process is shown in Figure 6-2-5

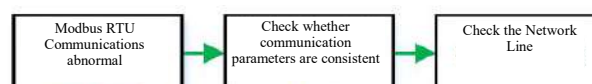

Figure 6-2-5 Troubleshooting process

6.2.6 EtherNet/IP Communication Is Abnormal

- Check for abnormality of Keens EtherNet/IP communication:

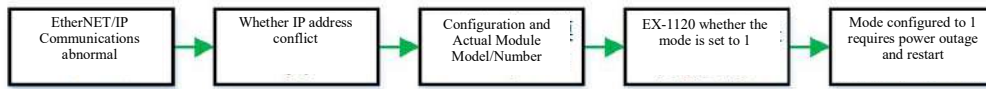

Figure 6-2-6 Troubleshooting flowchart for Keens EtherNet/IP

- Fault diagnosis of EtherNet/IP based on CODESYS software platform (including Omron, Schneider, Huichuan) communication:

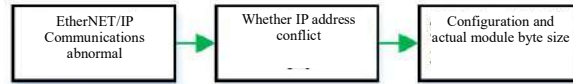

Figure 6-2-6 Troubleshooting process for EtherNet/IP of other manufacturers

6.3 Using Modules

6.3.1 Encoder Module

- In the encoder module, there are three signal types: differential, NPN and PNP, but the modules are used in the same way. The input and output are shown in Table 6-3-1, and the basic configuration process is shown in Figure 6-3-1.

Table 6-3-1 Input and output channels of the encoder module

No.	Channel name	Channel type	Data type	description
1	Set Initvalue Enable	Output	BOOL	Setting the initial value
2	Z Phase Enable	Output	BOOL	Z-phase enabler
3	Counting Direction	Output	BOOL	Counter direction
4	Count Enable	Output	BOOL	Count enabler
5	Latch Enable	Output	BOOL	Lock-in enabler
6	Initial Count Value	Output	UDINT	Initial count
7	Latch Signal	Input	BOOL	Latch signal
8	Count Value	Input	UDINT	count value
9	Latch Value	Input	UDINT	Latch value
10	Temperature Alarm	Input	BOOL	Temperature alarm
11	Voltage Alarm	Input	BOOL	Voltage alarm

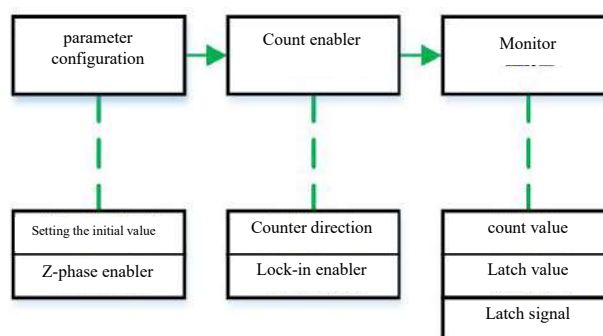

Figure 6-3-1 Basic configuration process

6.3.2 High-speed pulse output module

- In the high-speed pulse output module, there are three signal types: differential, NPN, and PNP, but the modules are used in the same way. The input and output are shown in Table 6-3-2 and the basic configuration process is shown in Figure 6-3-2.

Table 6-3-2 Input and output channels of high-speed pulse output module

No.	Channel name	Channel type	Data type	description
1	Direction Control	Output	BOOL	Direction control
2	Inching Enable	Output	BOOL	dot mode enabler
3	Inching Control	Output	BOOL	Inching operation
4	Location Enable	Output	BOOL	Location mode enabler Positioning operation
5	Location Control	Output	BOOL	Emergency stop
6	Emergency Stop Enable	Output	BOOL	Pulse direction
7	Direction Pulse Mode	Output	BOOL	CW/CCW mode
8	CW/CCW Mode	Output	BOOL	Orthogonal mode
9	Orthogonal Mode	Output	BOOL	Positive and negative orientation
10	Negative[0] Or Positive[1] Logic	Output	BOOL	Slope start
11	Ramp Enable	Output	BOOL	Initial pulse frequency
12	Start Pulse Frequency	Output	UDINT	Pulse output frequency
13	Output Pulse Frequency	Output	UDINT	Locating pulse number
14	Location Pulse	Output	UDINT	Acceleration Time
15	Ramp Increase Time	Output	UINT	Deceleration time
16	Ramp Decrease Time	Output	UINT	Locate the complete flag bit
17	Location Finish Flag	Input	BOOT	Operating status bit
18	Operation Status Flag	Input	BOOT	Pulse output feedback number
19	Location Or Inching Pulse Feedback	Input	UDINT	Temperature alarm
20	Temperature Alarm	Input	BOOL	Voltage alarm
21	Voltage Alarm	Input	BOOL	Primary parameter is invalid
22	Master Station Parameters Ilegality	Input	BOOL	Pulse output fault
23	Pulse Output Failure	Input	BOOL	Direction control

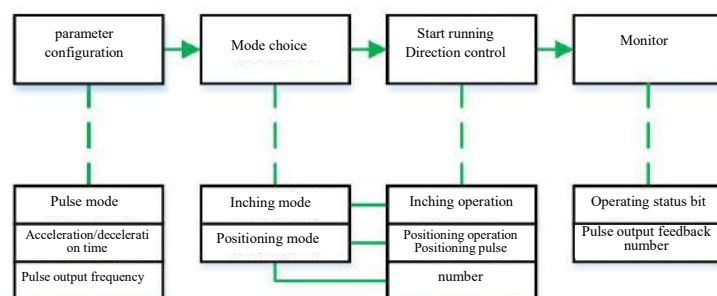

Figure 6-3-2 Basic configuration process

- Figure 6-3-3 shows the process for configuring the control mode

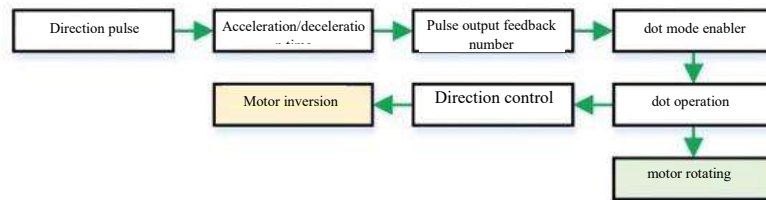

Figure 6-3-3 Dynamic mode configuration process

- Figure 6-3-4 shows the process for configuring the location control mode

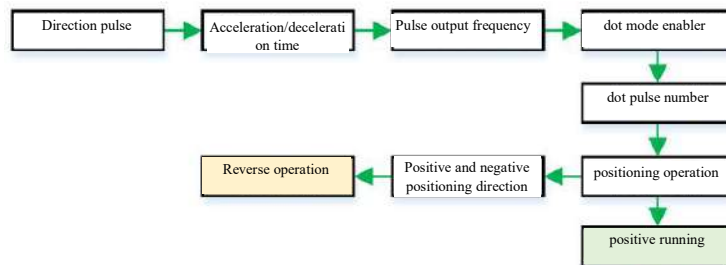

Figure 6-3-4 Configuration of the positioning control mode

6.3.3 EX-6311/6301 Free communication module use

- There are four modes of module communication:
 - (1) Send-rev mode: trigger mode and receive data at character intervals.
 - ② Send-send mode: trigger sending mode;
 - ③ Rev-send mode: triggers the sending mode and receives data at character intervals.
 - ④ Rev-rev mode: Receive data at character intervals.
- Table 6-3-3 lists the communication parameters

Table 6-3-3 Communication parameters

parameter name	Parameter meaning	parameter
BaudRate	Baud rate	1200/2400/4800/9600 (default) / 19.2 K / 38.4 K / 57.6 K / 115.2 K
Data Bits	Data bits	5 bit /6 bit /7 bit /8 bit (default)
Parity Bits	Check digit	None Check (default)/parity check/even check

Stop Bits	Stop bit	1 bit (default) /2 bits
Interval Time	Automatic timing sending function	Timing send interval from 50ms to 10s optional (1s by default)
Comm Mode	Communication mode selection	M/S (master/slave), default master mode

Note: Parameter Settings need to be configured before the module runs. For example, if you use TwinCAT, set the parameters in Startup.In OMROM software, the corresponding module needs to be found and set in the edit initialization parameter setting of the module.If no operation is required, use the default value.

- Process data - Output data

The output data length is 66 bytes. The first two bytes are data length and control word respectively, and the last 64 bytes are data bytes, as shown in Figure 6-3-5.

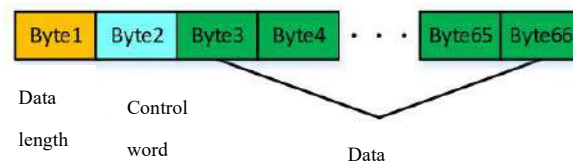

Figure 6-3-5 Process data - Output data

The data length and the meanings of single bits in the control words are shown in Table 6-3-4.

Table 6-3-4 Data length and control words

The name of the	The length of the	Bit definition	
The length of the data	1 byte	-	The length of the data is N, and the maximum value of N is 64
Control word	1 byte	Bit0	TxE starts sending flags When TxM =0, it is the trigger mode. At this time, only when TxE changes from 0 to 1 (rising edge), a sending is triggered. Automatic send mode when TxM=1 In this case, only when TxE is 1, the module automatically sends packets continuously according to the Automatic sending Interval specified in the configuration information.
		Bit1	TxM sending mode TxM=0: triggers the sending mode TxM=1: automatic timing sending mode

		Bit2	Relen receives by length Relen =0 Received by character interval: 3.5 consecutive characters (with baud rate, number of characters, and check whether or not) after a character is received When the next character is not received, the packet is considered to be closed Beam.
		Bit3	Channel 0:0
		Bit4	keep
		Bit5	keep
		Bit6	Set_re forcibly waits for receiving
		Bit7	Set_tr Forcibly sets the receive completion/send permit status

Table 6-3-5 describes the Bit0 and Bit1 modes in the control word.

Table 6-3-5 Control word Bit0 and Bit1 modes

Bit1 state	Bit0 state	Delivery mode	instructions
0	The 0-1	Trigger mode	Complete a send
0	0	Trigger mode	Don't send
1	1	Automatic mode	According to Auto Send Interval, automatic continuous sending is enabled
1	0	Automatic mode	Don't send

The mode definitions of Bit6 and Bit7 in the control words are shown in Table 6-3-6.

Table 6-3-6 Control word Bit6 and Bit7 mode definitions

Bit7 state	State of Bit6	function
1	0	Set_tr: Force reok_TREn =1, so that RS485 is in the receiving complete/sending allowed state
0	1	Set_re: Force REok_tren =0 to make RS485 in the waiting for receiving state
1	1	No role
0	0	No role

- Process data - Input data

The input data length is 66 bytes. The first two bytes are data length and communication status respectively, and the last 64 bytes are data bytes, as shown in Figure 6-3-6.

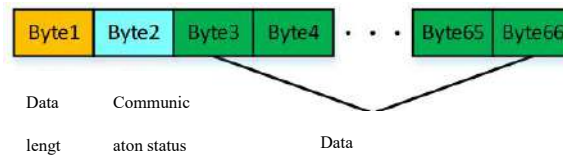

Figure 6-3-6 Process data - Input data

For example, if the received data is 04 01 01 02 03 04, the data length is 4 bytes. The communication status is receiving completed or sending allowed. The received data is 01 02 03 04.

Table 6-3-7 shows the data length and the meaning of a single bit of the communication status word.

Table 6-3-7 Data length and communication status words

name	length	Bit definition	
The length of the data	1 byte	-	The length of the data is N, and the maximum value of N is 64
Communication status	1 byte	Bit0	Reok_tren Receiving completed or sending allowed Reok_tren =1: The RS485/RS232 interface is in the receiving complete/sending Allowed state. Reok_tren =0: The RS485/RS232 interface is in waiting state.
		Bit1	Tr_ing is sending Tr_ing =1: The RS485/RS232 interface is sending data. Tr_ing =0: THE RS485/RS232 interface is not sending data.
		Bit2	Re_ing is receiving Re_ing =1: The RS485/RS232 interface is receiving data. Re_ing =0: The RS485/RS232 interface is not receiving data.
		Bit3	keep
		Bit4	keep
		Bit5	keep

		Bit6	keep
		Bit7	keep

The Bit0, Bit1, and Bit2 modes in the communication status word are defined as shown in Table 6-3-8.

Table 6-3-8 Definition of Bit0, Bit1 and Bit2 modes in the communication state word

Bit2 state	Bit1 state	Bit0 state	function
0	0	1	RS485 is in the state of "receiving completed/sending allowed". If TxE starts from 0 to 1, RS485 switches to D2D1D0=010, that is, data in the output data area is sent to RS485/RS232 equipment.
0	1	0	RS485/RS232 packets are being sent to the RS485 device.
0	0	0	RS485/RS232 is in the waiting state, that is, waiting to receive data packets from the RS485/RS232 device.
1	0	0	RS485/RS232 receiving packets from the RS485/RS232 device.

- Module operation mode

① **Send_Rev mode :(trigger mode, receive at character intervals)**

(1) The module is powered on (configuration information is in main mode by default), D2D1D0 of Status byte =001, and the RS485 interface is in receive completed/Send Allowed state.

(2) Control byte = 0x0801, trigger mode, start sending mark, according to character interval, channel number 0, TxE start sending mark changes from 0 to 1, rising edge sends 8 bytes of data;

(3) D2D1D0=000 in status byte, the status word is 0, and the RS485 interface is in the "Waiting for receiving" state.

(4) Module status STATUS D2D1D0 of BYTE is 001, and the RS485 port is in the receive completed/Send Allowed state.

(5) The master station waits for D2D1D0 of Status byte =001 and the module is in the "receiving completed/sending allowed" state before sending the next operation.

(6) Go to Step 1.

② **send-send mode :(trigger sending mode)**

(1) The module is powered on (configuration information is in main mode by default), D2D1D0 of Status byte =001, and the RS485 interface is in receive completed/Send Allowed state.

(2) Control byte = 0x0801, trigger mode, start sending mark, according to character interval, channel number 0, TxE start sending mark changes from 0 to 1, rising edge sends 8 bytes of data;

(3) D2D1D0=000 in status byte, the status word is 0, and the RS485 interface is in the "Waiting for receiving" state.

(4) The master station detects the communication state word D2D1D0=000, and the strong control word D7d6 =10, namely set_tr=1,

Set_re = 0; Make the bus bridge enter the state of "receiving completed/sending allowed", and the communication status word D2D1D0=001.

(5) Master station recovery control word D7 D6=00;

(6) Go to Step 1.

③ rev-send mode :(Triggering the sending mode and sending at character intervals)

(1) The module is powered on (the configuration information is changed to slave mode), and the communication status word D2D1D0=000, that is, reOK_TREn =0; Waiting for receiving state;

(2) When the RS485/RS232 interface finishes receiving packets, the communication status word D2D1D0=001, namely reOK_TREn =1; Receiving completed/sending allowed status;

(3) master station start send TxE start send mark from 0 to 1, control word control byte = 0x0801, trigger mode, according to character interval close, channel number 0, TxE start send mark from 0 to 1, rising edge send 8 bytes of data;

(4) D2D1D0=000 in status byte, the status word is 0, and the RS485 interface is in the waiting for receiving state.

(5) Go to Step 1

④ rev-rev mode :(Receive at character intervals)

(1) The module is powered on (the configuration information is changed to slave mode), and the communication status word D2D1D0=000, that is, reOK_TREn =0; Waiting for receiving status.

(2) When the RS485 interface finishes receiving packets, the communication status word D2D1D0=001, that is, REOK_TREn =1; Receiving completed or sending allowed status.

(3) The master station detects the communication state word D2D1D0=001, and the strong control word D7D6 =01, that is, set_tr=0,

Set_re =1, make RS485/RS232 enter "waiting for receiving" state;

(4) Master station recovery control word D7 D6=00;

- Figure 6-3-7 shows the process for using the EX-6301 with the serial port Debugging Assistant.

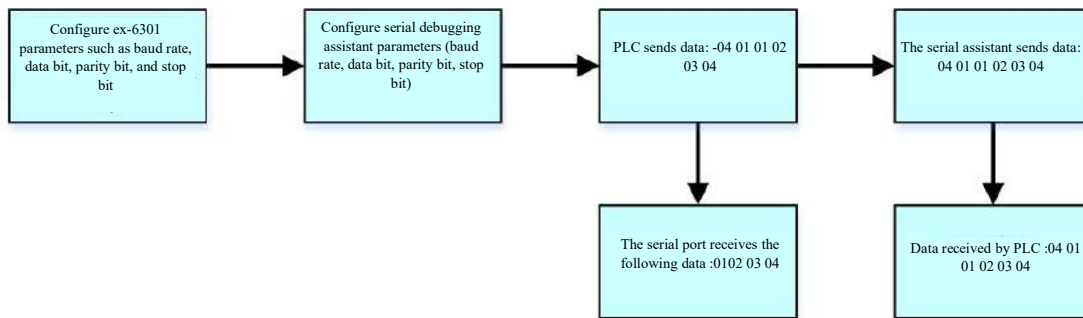

Figure 6-3-7 Usage process

6.3.4 TIA Portal Configures ex-6321 modules

After ex-1110 is configured on the TIA Portal, add ex-6321 (Modbus RTU Master module) to the slot, as shown in Figure 6-3-8.

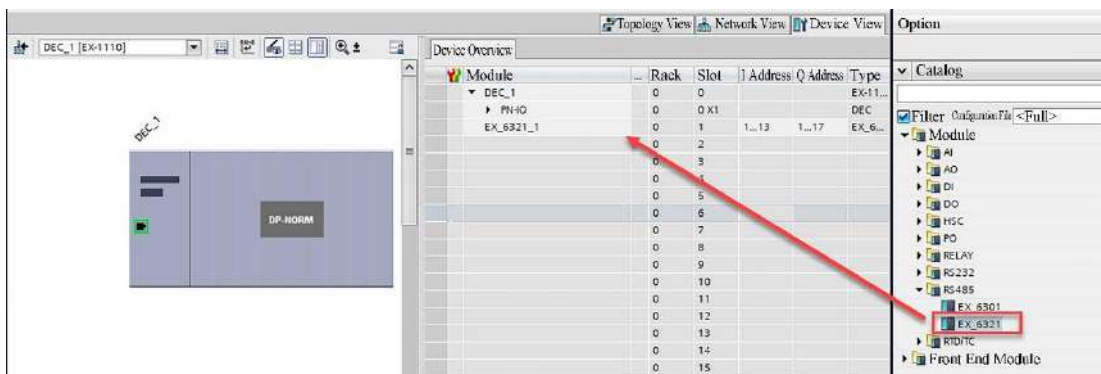

Figure 6-3-8 Configuration of the EX-6321 module

To configure ex-6321 communications parameters, right-click module in the slot and choose Properties to set communications parameters, as shown in Figure 6-3-9.

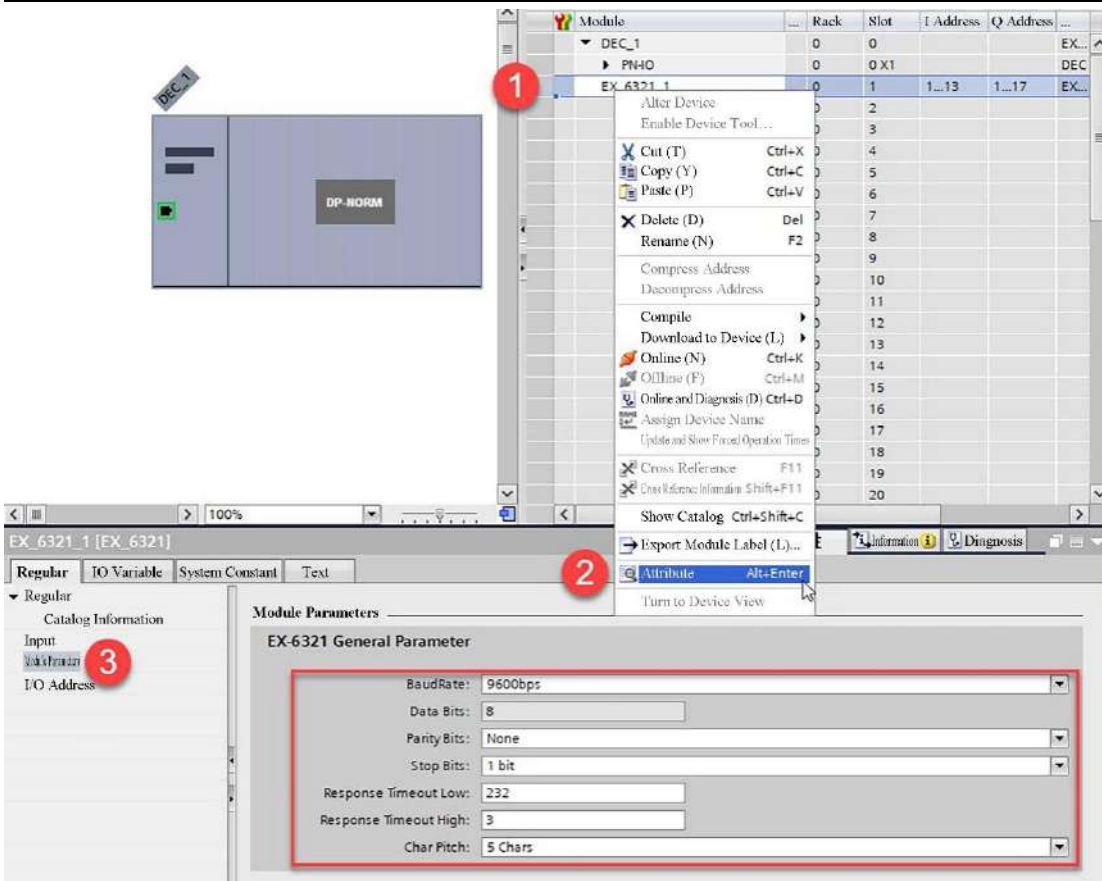

Figure 6-3-9 Configuring ex-6321 communication parameters

Table 6-3-9 lists the configurable parameters of ex-6321, such as baud rate, parity check, stop bit, and communication timeout

Table 6-3-9 Definitions of communication parameters

The serial number	parameter	instructions	note
1	BaudRate	Baud rate	Users can choose standard baud rate
2	Data Bits	Data bits	Fixed for 8 bit
3	Parity Bits	parity	This parameter is configurable by default
4	Stop Bits	Stop bit	The default value is 1 bit
5	Response Timeout Low	Timeout low bytes	For example, if the communication timeout is 1000ms, it is converted to hexadecimal 0x03E8, whose decimal value is 232
6	Response Timeout High	Timeout high byte	For example, if the communication timeout is 1000ms, it is converted to hexadecimal 0x03E8. The decimal value of 03 is 03

7	Char Pitch	Characters in length	The default value is 5char, which is configurable
---	------------	----------------------	---

EX-6321(Modbus RTU Master module) address assignment table in case 6-3-8, as shown in Figure 6-3-9.

Output area (Q area)			
No	Address	Description	Note
1	Q1.0	Data sending	0 →1: data is sent 1 →0: sending is disabled
2	QW2	Modbus RTU Slave station	0-255
3	QW4	Modbus Fuction code	Supported Function code :01/02/03/04/05/06/15/16
4	QW6	Slave station Depository Address	0-65535
5	QW8	The length of data read or written	Length value: 1-4
6	QW10	The master station sends data #1	Valid only for register writing
7	QW12	The master sends data #2	
8	QW14	The master sends data #3	
9	QW16	The master sends data #4	
input area (I area)			
No	Address	Description	Note
1	I1.0	Send complete flag bit	0→1: Data is sent
2	I1.1	Receive completion flag bit	0→1: Data is received
3	IW2	Modbus RTU returns from the secondary address	Returns the slave address
4	IW4	Modbus RTU communication error code from	0: The communication is normal
5	IW6	The station returns data #1	
6	IW8	Return data #2 from the station	
7	IW10	Return data #3 from the station	
8	IW12	Return data #4 from the station	

Figure 6-3-9 Address allocation table

For example, read Modbus RTU slave station #1 register 40001/40002/40003/40004:

QW2, QW4, QW6, and QW8 correspond to 01 03 00 04

Then set Q1.0 to TRUE

In IW6/IW8/IW10/IW12, you can view the data of register 40001/40002/40003/40004.

For example, write data to Modbus RTU slave station #2 register 40010/40011/40012/40013 to 100, 3000, 80, 300 respectively:

QW2 QW4 QW6 QW8 QW10 QW12 QW14 QW16 The corresponding data is 01 16 00 04 100 3000 80 300

Then set Q1.0 to TRUE

Note: Q1.0 pin from 10, IW6/IW8/IW10/IW12 data will be automatically cleared

6.3.5 TwinCAT3 configuration EX-6321

After TwinCAT3 is enabled, configure ex-1100, and add ex-6321 to the slot, as shown in Figure 6-3-10.

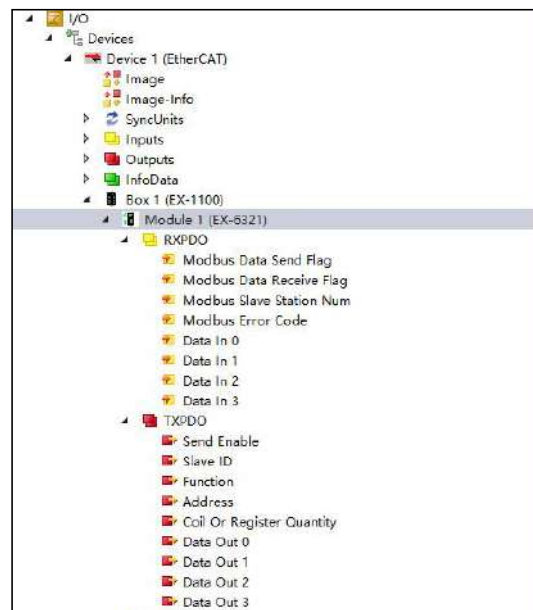

Figure 6-3-10 Configuration of the EX-6321 module

To configure ex-6321 communication parameters, double-click Box 1 (EX-1100) > StartUP, right-click the blank area, and choose Add New Item. In the StartUP parameter window, select EX-6321 to set communication parameters, as shown in Figure 6-3-11.

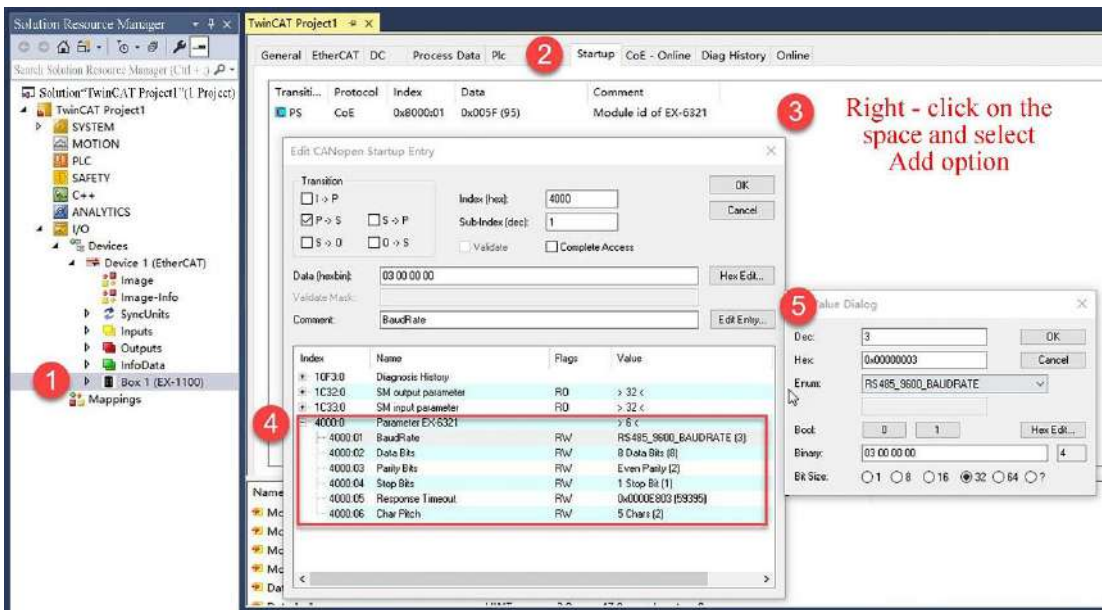

Figure 6-3-11 Setting ex-6321 communication parameters

Table 6-3-10 lists the configurable parameters of ex-6321, such as baud rate, parity check, stop bit, and communication timeout

Table 6-3-10 Definitions of communication parameters

The serial number	parameter	instructions	note
1	BaudRate	Baud rate	Users can choose standard baud rate
2	Data Bits	Data bits	Fixed for 8 bit
3	Patity Bits	parity	This parameter is configurable by default
4	Stop Bits	Stop bit	The default value is 1 bit
5	Reapons Timeout	timeout	Communication timeout value, in ms
6	Char Pitch	Characters in length	The default value is 5char, which is configurable

Table 6-3-11 describes the functions of the EX-6321 INPUT and output addresses

Table 6-3-11 Functions of the INPUT and output addresses and their descriptions

The serial number	parameter	instructions	note
Output area (Q area)			
The serial	pin	instructions	note

number			
1	Send_Enable	Data sent	0 to 1: data is sent 1 to 0: sending is disabled
2	Slave_ID	Modbus slave address	1-255.
3	Funtion	Mdobus function code	Support function code: 01/02/03/04/05/06/15/16
4	Address	Slave register address	0-65535.
5	Coil Or Register Quantity	The length of data read or written	Length value: 1-4
6	Data Out 0	The master station sends data #1	Valid only for register writing
7	Data Out 1	The master sends data #2	
8	Data Out 2	The master sends data #3	
9	Data Out 3	The master sends data #4	
Output area (I area)			
The serial number	pin	instructions	note
1	Modbus Data Send Flag	Send complete flag bit	0 to 1: Data is sent
2	Modbus Data Receive Flag	Receive completion flag bit	0→1: Data is received
3	Modbus Slave Station Num	Modbus RTU returns from the secondary address	Returns the slave address
4	Modbus Error Code	Modbus RTU communication error code	0: The communication is normal
5	Data In 0	Return data #1 from the station	The read slave register data is returned
6	Data In 1	Return data #2 from the station	
7	Data In 2	Return data #3 from the station	
8	Data In 3	Return data #4 from the station	

For example, read Modbus RTU slave station #1 register 40001/40002/40003/40004:

Slave_ID -- "1"

Funtion - 03 (03 Function Code Reading)

Address - "00" (start Address 40001 corresponds to Address 0)

Coil Or Register Quantity -- 04

Send_Enable -- TRUE (Sending data)

The data returned from station #1 in register 40001/40002/40003/40004 are stored in:

Data In 0, Data In 1, Data In 2, Data In 3.

For example, write data to Modbus RTU slave station #2 register 40010/40011/40012/40013 to 100, 3000, 80, 300 respectively:

Slave_ID -- "2"

Funtion - 16 (03 Function Code Reading)

Address - "00" (start Address 40001 corresponds to Address 0)

Coil Or Register Quantity -- 04

Data Out 0-100

Data Out 1 -- 3000

Data Out 2 -- 80

Data Out 3 -- 300

Send_Enable -- TRUE (Sending data)

Note: Send_Enable pin from 10, Data out1-out4 Data will be cleared automatically

6.3.6 Setting the IP address of the EX-1121 Adapter

The DIP codes for the EX-1121 adapter are defined as follows:

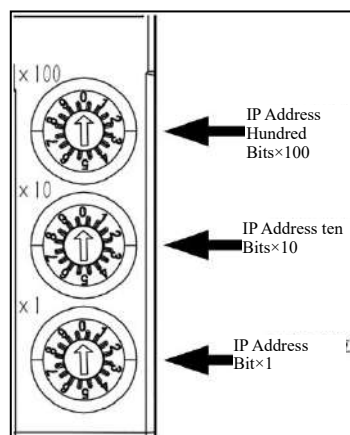

Figure 6-3-12 DIP switch of the EX-1121 adapter

Dip switch definition	
Three combination dip set values	IP address setting method

0	Set through BOOTP.
001-254.	Set the low 1byte of the IP address by turning the switch.
More than 255	The module status indicator (MS) is blinking red because the Settings are incorrect

(1) Through BOOTP

When setting the IP address through BOOTP, the three DIP switches of the adapter must be 0 before power-on. Run the IP Setting Tool software to scan for the online EX-1121 adapter, as shown in Figure 6-3-13. To configure the IP address of the module, double-click the EX-1121 adapter that needs to be configured with an IP address and configure the IP address, as shown in Figure 6-3-14. After the IP address is set, the software prompts that the IP address is set, as shown in Figure 6-3-15. Figure 6-3-16 shows the process for setting an IP address through BOOTP.

Note: When the IP address is first set in BOOTP mode, the three DIP switches must be 0. When an IP address has been set through BOOTP, the IP address is set through the rotation switch along with the high byte of the IP address set through BOOTP, and the low byte of the IP address becomes the set value of the rotation switch.

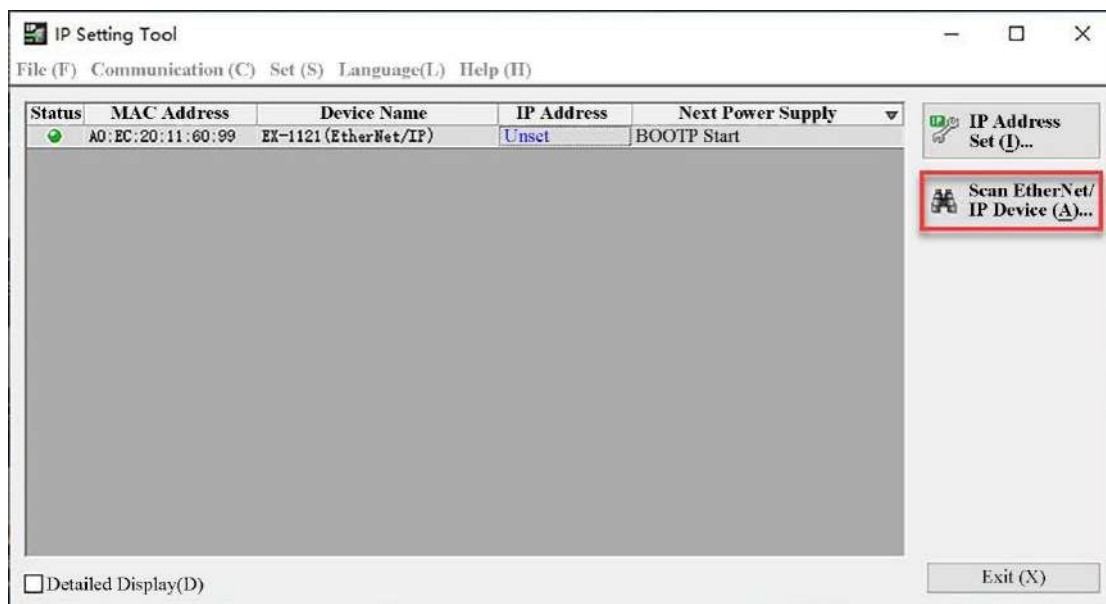

Figure 6-3-13 Scanning EtherNet/IP devices

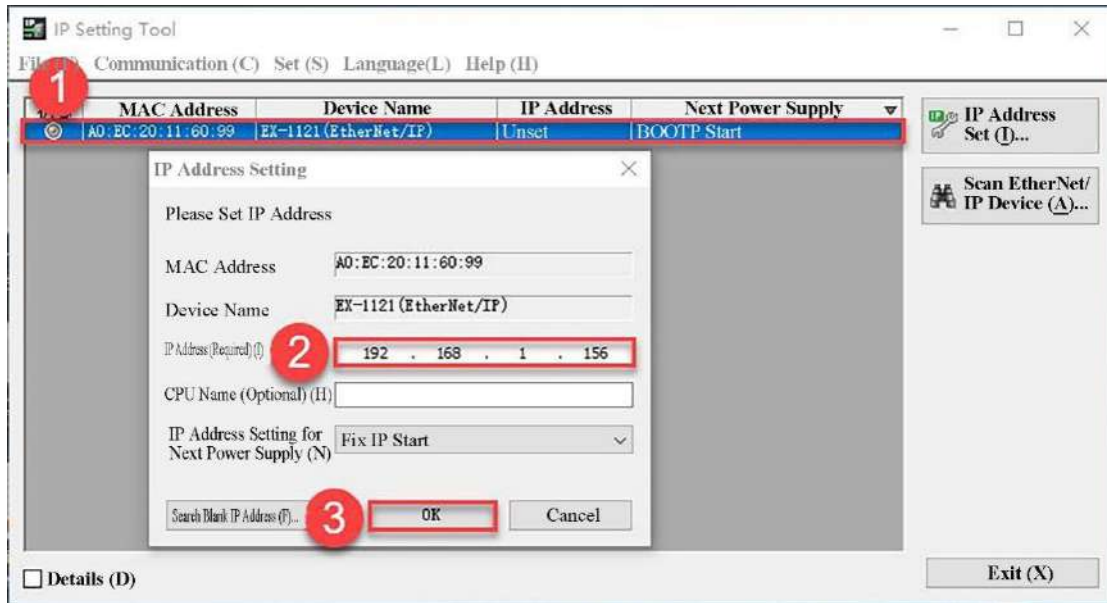

Figure 6-3-14 Setting the IP address

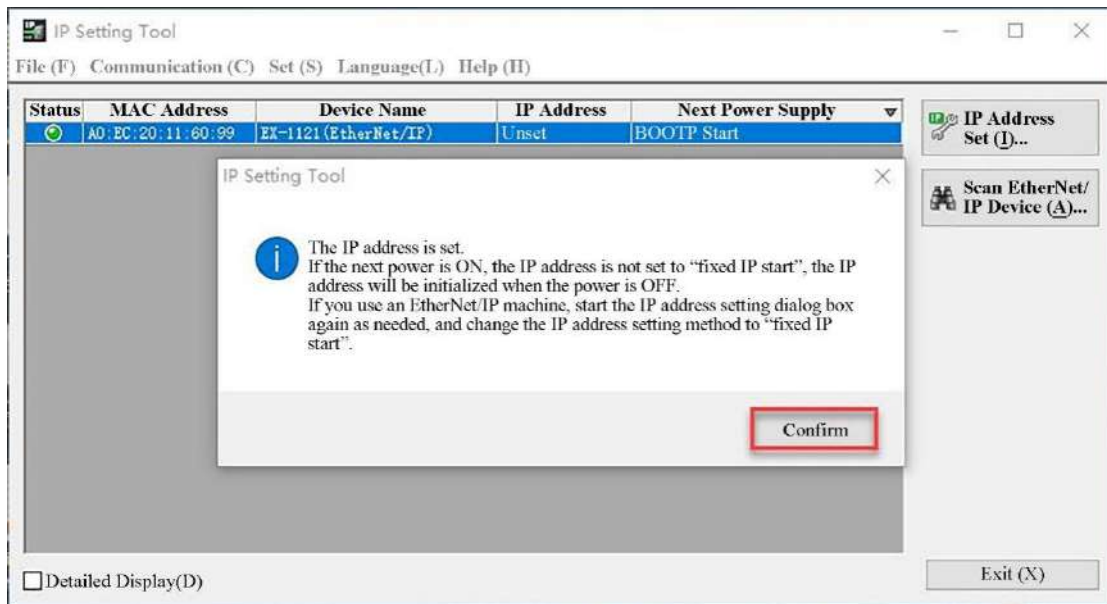

Figure 6-3-15 IP address setting completed

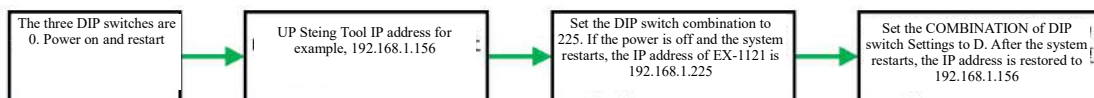

Figure 6-3-16 Setting the IP address using BOOTP

(2) Set by dip switch

Set the IP address using dip switches. The combination of the first three DIP switches is not 0 (1-254). Start the IP Setting Tool software and scan for the online EX-1121 adapter, as shown in Figure 6-3-17. To configure the IP address of the module, double-click the EX-1121 adapter to be

configured with an IP address and configure the IP address, as shown in Figure 6-3-18. After the IP address is set, the software prompts you that the IP address is set, as shown in Figure 6-3-19. Figure 6-3-20 shows the process for setting an IP address through BOOTP.

Note: The PC IPv4 network segment must be in the same network segment (192.168.0.x) as the EX-1121 adapter when you first set the IP address using the DIP switch.

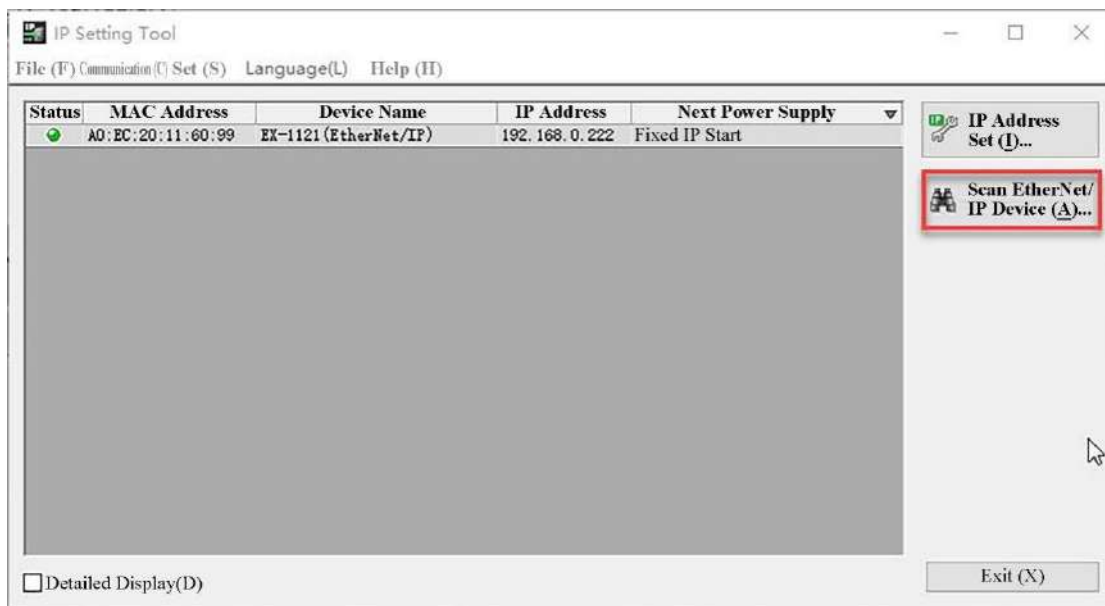

Figure 6-3-17 Scanning EtherNet/IP devices

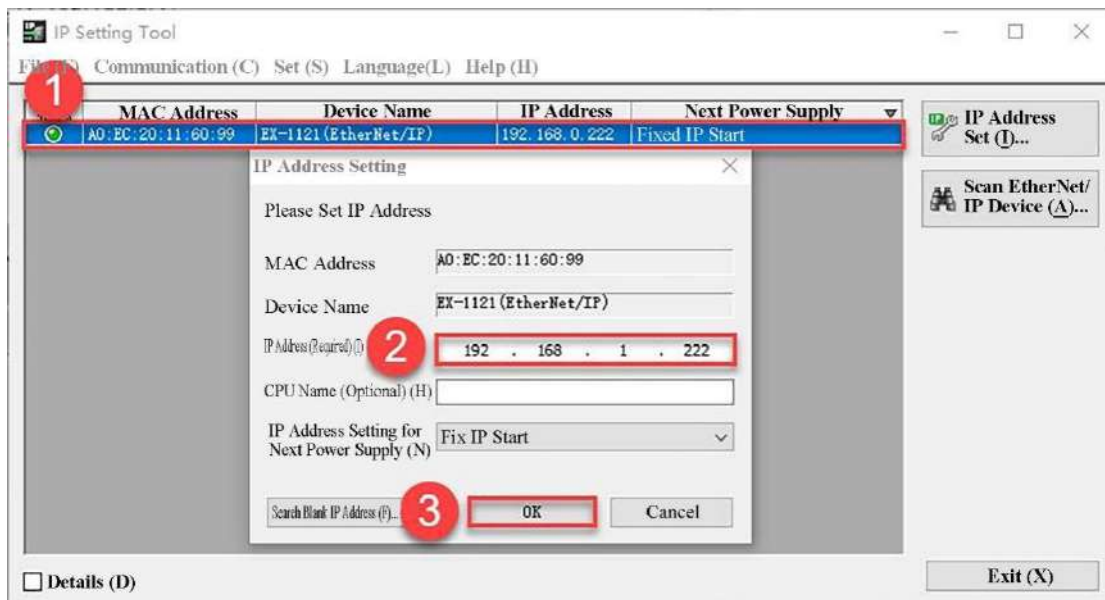

Figure 6-3-18 Modifying the module network segment

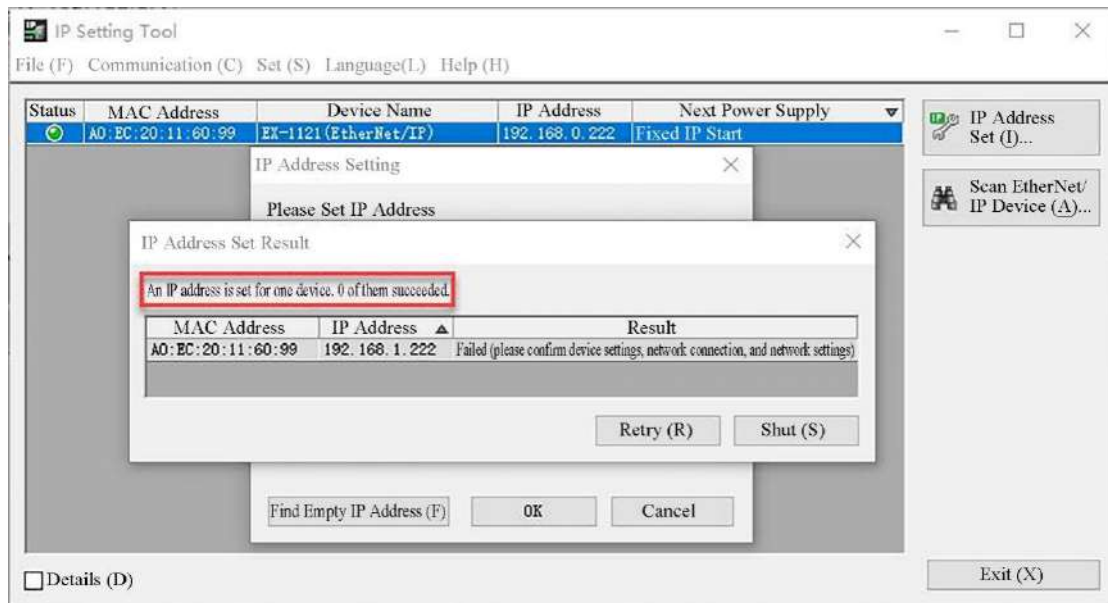

Figure 6-3-19 IP address setting completed

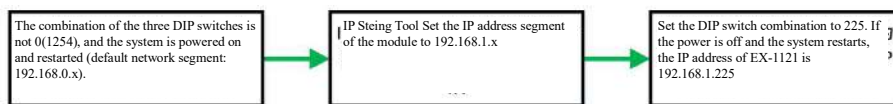

Figure 6-3-20 Setting the IP network segment using DIP switches

The Appendix

1. Modbus address table of ex-1030 module

Register address	Data area	Description	note
0x0000 0x00FF	Input process data area	Input process data area	
0x0800 0x08FF	Output process data area	Output process data area	
0x1000- 0x1006	Read-only diagnostic data area 1	MODBUS indicates the name	The character is ex-1030. Unused characters are filled with 0
0x1007		Software Version number	A value of 0x1000 indicates version V1.0.0.0
0x1008		Hardware Version number	Same as above
0x1009-		keep	

0x100E		
0x100F	RTU coupler status	Bit0 is the local bus state (a value of 1 indicates that the local bus is abnormal) Bit15 is the fieldbus state (a value of 1 means watchdog times out) Other bits reserved
0x1010	Slave status (high 1 byte) Number of slave stations (low 1 byte)	Slave state: 0-Connect to normal 1- Disconnect from the station
0x1011	The total byte size of the data area occupied by the analog output	For example, if a 4-channel AO module is connected and a single channel occupies 2 bytes, the value of this item is 8
0x1012	The total size of the data area occupied by the analog input in bytes	For example, if a four-channel AI module is connected and a single channel occupies 2 bytes, the value of this item is 8
0x1013	The total size in bytes of the data area occupied by the digital output	If the 8-channel DO module is connected, the data should be 1 byte
0x1014	The total size of the data area occupied by the digital input in bytes	For example, if a 7-channel DI module is connected, the value of this item is 1 byte. If the value is less than 8 bits, the value is 8 bits
0x1015	Current watchdog time ms	It can be set by dip switch or address 0x2000
0x1016	The topology of 1	Module ID(2 bytes). Each model has a unique ID. If IO exists, the module ID is displayed; if no module exists, 0 is displayed.
0x1017	The topology of 2	Same as above
--	--	
0x1035	The topology of 32	Same as above

0x2000	Read (0x03)/write (0x10) configuration data area	Set watchdog time ms. Watchdog is disabled by factory default	The maximum support is 65000MS and the minimum unit is 100ms. 0 indicates that the watchdog function is disabled
0x2001		The watchdog resets the register	You must use function code 06 or 0F and write the value 0xAE01 first and then 0xAE02
0x2002		Watchdog type	0-Indicates packet watchdog (default) 1-Indicates that the watchdog writes packets See Note 1
0x2003		Check digit	0-No check 1-Odd parity 2-Parity checking
0x2004		Stop bit	1-1 stop bit 2-2 stop bits
0x2005		Frame end time	Ms (default 0, depending on baud rate, other values such as 1, 1ms, maximum 10ms)

Note 1:

Guard dog

The watchdog is disabled in factory Settings. The watchdog can be enabled by writing time (say 1000ms) to address 0x2000. The watchdog registers (0x2000, 0x2002) are written and restart to take effect. The data in this register is reserved.

After receiving the request packet for the first time, the watchdog timer is started. After receiving the request packet, the watchdog timer is triggered again. In the second method, after the first telegram is written, the watchdog timer starts and is triggered each time a written telegram is received from the device. To do this, write 1 to register 0x2002 (default "0"). If the slave's watchdog timer has expired, it can be rewritten by writing twice to register 0x2001. This must be written to the register by function code 06 or 0F :0xAE01 0xAE02.

Note 2.

All configuration data areas except reset watchdog register (0x2001) Settings do not need to be powered off, all other Settings need to be powered off to take effect.

2. Order information of remote IO products

Product model	The product description	The order no.
The adapter		
EX-1010	DeviceNet adapter	02-01-01
EX-1130	Modbus TCP adapter	02-01-07

EX-1030	Modbus RTU adapter	02-01-03
EX-1100	EtherCAT adapter	02-01-04
EX-1110	PROFINET adapter	02-01-05
EX-1112	PROFINET adapter	02-01-05-1
EX-1040	CC - Link adapter	02-01-06
EX-1120	EtherNet/IP adapter	02-01-08
EX-1121	EtherNet/IP adapter	02-01-08-1
EX-1140	CC-link IE Filed Basic	02-01-09
Digital input module		
EX-2008	8 channel digital input module NPN type	02-02-01
EX-2108	8 channel digital input module PNP type	02-02-02
EX-200H	16 channel digital input module NPN type	02-02-03
EX-210H	16 channel digital input module PNP type	02-02-04
EX-2C0S	32 channel digital input module NPN&PNP compatible	02-02-05
Digital output module		
EX-3008	8-channel digital output module NPN type	02-03-01
EX-3108	8 channel digital output module PNP type	02-03-02
EX-300H	16 channel digital output module NPN type	02-03-03
EX-310H	16 channel digital output module PNP type	02-03-04
EX-3208	8 channel relay output module	02-03-05
EX-300S	32 channel digital output module NPN type	02-03-06
EX-310S	32 channel digital output module PNP type	02-03-07
Analog input module		
EX-4014	4-channel analog input module 0-10V 12-bit accuracy 0.1%	02-04-01
EX-4014	4-channel analog input module 0-5V 12-bit accuracy 0.1%	02-04-02
EX-4114	4-channel analog input module $\pm 10V$ 12 bit accuracy 0.1%	02-04-03
EX-4114	4-channel analog input module $\pm 5V$ 12-bit accuracy 0.1%	02-04-04
EX-4054	4-channel analog input module 0-10V 16-bit accuracy 0.02%	02-04-05
EX-4054	4-channel analog input module 0-5V 16-bit accuracy 0.02%	02-04-06
EX-4154	4-channel analog input module $\pm 10V$ 16-bit accuracy 0.02%	02-04-07
EX-4154	4-channel analog input module $\pm 5V$ 16-bit accuracy 0.02%	02-04-08
EX-4414	4-channel analog input module 4-20mA 12-bit accuracy 0.1%	02-04-09

EX-4414	4-channel analog input module 0-20mA 12-bit accuracy 0.1%	02-04-10
EX-4454	4-channel analog input module 4-20mA 16-bit accuracy 0.02%	02-04-11
EX-4454	4-channel analog input module 0-20mA 16-bit accuracy 0.02%	02-04-12
EX-4018	8-channel analog input module 0-10V 12-bit accuracy 0.1%	02-04-29
EX-4018	8-channel analog input module 0-5V 12-bit accuracy 0.1%	02-04-30
EX-4118	8 channel analog input module $\pm 10V$ 12 bit accuracy 0.1%	02-04-31
EX-4118	8 channel analog input module $\pm 5V$ 12 bit accuracy 0.1%	02-04-32
EX-4418	8-channel analog input module 4-20mA 12-bit accuracy 0.1%	02-04-33
EX-4418	8-channel analog input module 0-20mA 12-bit accuracy 0.1%	02-04-34
Thermocouple (TC) input module		
EX-4654	4 channel thermocouple (TC) input module (2 wire) TYPE K	02-04-13
EX-4654	4 channel thermocouple (TC) input module (2 wire) J	02-04-14
EX-4654	4 channel thermocouple (TC) input module (2 wire) Model T	02-04-15
EX-4654	4 channel thermocouple (TC) input module (2 wire) Type E	02-04-16
EX-4654	4-channel thermocouple (TC) input module (2-wire) Type N	02-04-17
EX-4654	4-channel thermocouple (TC) input module (2-wire) model S	02-04-18
EX-4654	4-channel thermocouple (TC) input module (2-wire) Type R	02-04-19
EX-4654	4 channel thermocouple (TC) input module (2 wire) Type B	02-04-20
EX-4654	4 channel thermocouple (TC) input module (2 wire) Type C	02-04-21
EX-4654	4 channel thermocouple (TC) input module (2 wire system) voltage measurement	02-04-22
Thermal resistance (RTD) input module		
EX-4754	4 channel thermal resistance (RTD) input module 2 wire or 3 wire (default 3 wire) PT100	02-04-23

EX-4754	4 channel thermal resistance (RTD) input module 2 wire or 3 wire (default 3 wire) PT200	02-04-24
EX-4754	4 channel thermal resistance (RTD) input module 2 wire or 3 wire (default 3 wire) PT500	02-04-25
EX-4754	4-channel thermal resistance (RTD) input module 2-wire or 3-wire PT1000 (default 3-wire)	02-04-26
EX-4754	4 channel thermal resistance (RTD) input module 2 wire or 3 wire (default 3 wire) Ni120	02-04-27
EX-4754	4 channel thermal resistance (RTD) input module 2 wire or 3 wire system (default 3 wire system) resistance measurement	02-04-28
Analog output module		
EX-5014	4-channel analog output module 0-10V 12-bit accuracy 0.1%	02-05-01
EX-5014	4-channel analog output module 0-5V 12-bit accuracy 0.1%	02-05-02
EX-5114	4-channel analog output module $\pm 10V$ 12 bit accuracy 0.1%	02-05-03
EX-5114	4-channel analog output module $\pm 5V$ 12 bit accuracy 0.1%	02-05-04
EX-5054	4-channel analog output module 0-10V 16-bit accuracy 0.02%	02-05-05
EX-5054	4-channel analog output module 0-5V 16-bit accuracy 0.02%	02-05-06
EX-5154	4-channel analog output module $\pm 10V$ 16-bit accuracy 0.02%	02-05-07
EX-5154	4-channel analog output module $\pm 5V$ 16-bit accuracy 0.02%	02-05-08
EX-5414	4-channel analog output module 4-20mA 12-bit accuracy 0.1%	02-05-09
EX-5414	4-channel analog output module 0-20mA 12-bit accuracy 0.1%	02-05-10
EX-5454	4-channel analog output module 4-20mA 16-bit accuracy 0.02%	02-05-11
EX-5454	4-channel analog output module 0-20mA 16-bit accuracy 0.02%	02-05-12
EX-5018	8-channel analog output module 0-10V 12 bit accuracy 0.1%	02-05-13
EX-5018	8-channel analog output module 0-5V 12-bit accuracy 0.1%	02-05-14
EX-5118	8-channel analog output module $\pm 10V$ 12 bit accuracy 0.1%	02-05-15

EX-5118	8-channel analog output module $\pm 5V$ 12 bit accuracy 0.1%	02-05-16
EX-5418	8-channel analog output module 4-20mA 12-bit accuracy 0.1%	02-05-17
EX-5418	8-channel analog output module 0-20mA 12-bit accuracy 0.1%	02-05-18
Function module		
EX-6001	Single-channel NPN encoder module	02-06-01
EX-6011	Single channel PNP encoder module	02-06-02
EX-6021	Single channel differential encoder module	02-06-03
EX-6101	Single channel NPN pulse output module	02-06-07
EX-6111	Single channel PNP pulse output module	02-06-08
EX-6121	Single channel differential pulse output module	02-06-09
EX-6301	1 channel 485 free port communication module	02-06-12
EX-6311	1 channel 232 free port communication module	02-06-13
EX-6321	1 Modbus RTU Mater communication module	02-06-14
EX-TER01	Terminal module	02-00-00
EX-0100	System power supply and I/O power module	02-00-01
EX-0300	I/O power module	02-00-03
accessories		
cable	Bt04-100 40P cable	10-02-00
Terminal station	AT04	10-02-01



Nanjing Decowell Automation Co.,Ltd.

service hotline

+86-25-58252229

Address: Building 13, Ruichuang Intelligent Manufacturing Park,

No. 19 Lanxin Road, Pukou District, Nanjing

Email: contact@wellinkio.com

Website: www.wellinkio.com